



Rules For Classification And Construction  
**Part 1 Seagoing Ships**

**RULES FOR ELECTRICAL  
INSTALLATIONS**

**Volume IV**

July 2024 Edition





Rules for Classification and Construction  
**Part 1 Seagoing Ships**

# **RULES FOR ELECTRICAL INSTALLATIONS**

**Volume IV**

July 2024 Edition











**Amendments to the preceding Edition are marked by red colour and expanded text. However, if the changes involves the whole section or sub section normally only the title will be in red colour.**

Reproduction in whole or in part by any means of these Rules, is subject to the permission in writing by Biro Klasifikasi Indonesia Head Office.

## Foreword

This Rules is Rules for Electrical Installations (Pt.1, Vol.IV) new edition July 2024 replace the Rules for Electrical Installations (Pt.1, Vol.IV) 2024 consolidated edition. In this edition, new amendments are introduced which are mainly derived from IACS publications, and inputs from BKI Branch Offices and Technical Division BKI Head Office

The summary of previous edition and amendments including the implementation date are indicated in Table below:

	<b>Edition/ Rule Change Notice (RCN)</b>	<b>Effective Date</b>	<b>Link</b>
1	Consolidated Edition 2024	-	
2	RCN No.4, October 2023	1 <sup>st</sup> January 2024	
3	RCN No.3, April 2023	1 <sup>st</sup> July 2023	
4	RCN No.2, October 2022	1 <sup>st</sup> January 2023	
5	RCN No.1, April 2022	1 <sup>st</sup> July 2022	
6	Consolidated Edition 2022	-	
7	RCN No.1, November 2021	1 <sup>st</sup> July 2022	
8	Consolidated Edition 2021	-	
9	RCN No.1, December 2020	1 <sup>st</sup> January 2021	
10	Edition 2019	1 <sup>st</sup> July 2019	
11	Edition 2018	1 <sup>st</sup> July 2018	

**Note:** Full previous edition and amendments including its amendment notice is available through link above.

This rules is available to be downloaded at [www.bki.co.id](http://www.bki.co.id). Once downloaded, this Rules will be uncontrolled copy. Please check the latest version on the website

Further queries or comments concerning this Rules are welcomed through communication to BKI Head Office.

*This page intentionally left blank*

## Rules Amendment Notice

**Table 1 - Amendments incorporated in This Notice**

These amendments will come into force on 1<sup>st</sup> July 2024, except stated otherwise as indicated in the Table.

Paragraph	Title/Subject	Status/Remark
<b>Section 1 General Requirements and Guidance</b>		
<b>K.</b>	<b>Protective measure</b>	
<b>K.2.3</b>	Protective earthing	To add new reference
<b>K.5</b>	Lightning protection	To add new reference
<b>Section 10 Computer Systems</b>		
<b>All</b>	All	To supersede the section 10 with new requirements of IACS UR E22 Rev.3
<b>Section 24 Cyber Resilience of Ships</b>		
<b>A.</b>	<b>Introduction</b>	
<b>A.3</b>	Scope	To add new requirements in scope and application of ship type in accordance with IACS UR E26 Rev.1
<b>E.</b>	<b>Demonstration of compliance</b>	
<b>E</b>	Demonstration of compliance	Adding new requirements for the demonstration of compliance of cyber resilience of onboard systems and equipment in accordance with IACS UR E26 Rev.1
<b>F.</b>	<b>Risk assessment for exclusion of CBS from the application of requirements</b>	
<b>F.4</b>	Acceptance criteria	To add new requirement for acceptance criteria in accordance with IACS UR E26 Rev.1
<b>Section 25 Cyber Resilience of On-board Systems and Equipment</b>		
<b>A.</b>	<b>General</b>	
<b>A.3</b>	Scope	to add new requirements in scope and application of ship type in accordance with IACS UR E27 Rev.1
<b>B.</b>	<b>Security Philosophy</b>	
<b>B.3</b>	Essential systems availability	Renumbering the paragraph number
<b>B.4</b>	Compensating Countermeasures	Renumbering and superseding the requirements for the security measures for essential systems in accordance with IACS UR E27 Rev.1
<b>F</b>	Demonstration of compliance	Adding new requirements for the demonstration of compliance of cyber resilience of onboard systems and equipment in accordance with IACS UR E27 Rev.1

*This page intentionally left blank*



# Table of Contents

<b>Foreword</b> .....	<b>iii</b>
<b>Rules Amendment Notice</b> .....	<b>v</b>
<b>Table of Contents</b> .....	<b>vii</b>
<b>Section 1 General Requirements and Guidance</b> .....	<b>1-1</b>
A. General .....	1-1
B. Definitions .....	1-1
C. Documents .....	1-6
D. Further Rules and Standards to be Considered .....	1-10
E. Ambient Conditions .....	1-11
F. Operating Conditions .....	1-14
G. Power Supply Systems .....	1-15
H. Voltages and Frequencies .....	1-16
I. Visual and Acoustical Signalling Devices .....	1-16
J. Materials and Insulation .....	1-17
K. Protective Measures .....	1-18
<b>Section 2 Installation of Electrical Equipment</b> .....	<b>2-1</b>
A. Availability of Main Power Supply .....	2-1
B. Generators .....	2-1
C. Storage Batteries .....	2-2
D. Power Transformers .....	2-7
E. Electronics .....	2-8
F. Low -Voltage Switchboards (up to 1000 V AC resp. 1500 V DC) .....	2-8
G. Medium Voltage Equipment (> 1 kV - 17,5 kV AC) .....	2-9
<b>Section 3 Power Supply Installations</b> .....	<b>3-1</b>
A. Electrical Power Demand .....	3-1
B. Main Electrical Power Supply .....	3-1
C. Emergency Electrical Power Supply .....	3-7
D. Operation of the Emergency Generator in Port .....	3-10
<b>Section 4 Installation Protection and Power Distribution</b> .....	<b>4-1</b>
A. Three-Phase Main Generators .....	4-1
B. Emergency Three-Phase Generators .....	4-4
C. Direct Current Generators .....	4-4
D. Power Transformers .....	4-4
E. Storage Batteries .....	4-5
F. Power Electronics .....	4-5
G. Shore to Ship Connection .....	4-5
H. Consumer Protection Equipment .....	4-7
I. Power Distribution .....	4-7

<b>Section 5</b>	<b>Low-Voltage Switchgear Assemblies</b>	<b>5-1</b>
A.	General	5-1
B.	Calculations	5-1
C.	Construction	5-3
D.	Selection of Switchgear	5-6
E.	Choice of Electrical Protection Equipment	5-7
F.	Conductors and Busbar Carriers	5-10
G.	Measuring Instruments and Instrument Transformers	5-12
H.	Testing of Switchboards and Switchgear	5-12
<b>Section 6</b>	<b>Power Electronics</b>	<b>6-1</b>
A.	General	6-1
B.	Construction	6-1
C.	Rating and Design	6-1
D.	Cooling	6-2
E.	Control and Monitoring	6-2
F.	Protection Equipment	6-3
G.	Tests	6-3
<b>Section 7</b>	<b>Power Equipment</b>	<b>7-1</b>
A.	Steering Gear	7-1
B.	Lateral Thrust Propellers and Manoeuvring Aids	7-7
C.	Variable Pitch Propellers for Main Propulsion Systems	7-8
D.	Auxiliary Machinery and Systems	7-8
E.	Deck Machinery	7-10
F.	Electrical Heating Equipment and Heaters	7-11
G.	Heel-Compensating Systems	7-12
H.	Cross-flooding Arrangements	7-12
<b>Section 8</b>	<b>Medium Voltage Installations</b>	<b>8-1</b>
A.	Scope	8-1
B.	General Provisions	8-1
C.	Network Design and Protection Equipment	8-3
D.	Electrical Equipment	8-6
E.	Installation	8-11
<b>Section 9</b>	<b>Control, Monitoring and Ship's Safety Systems</b>	<b>9-1</b>
A.	General Requirements	9-1
B.	Machinery Control and Monitoring Installations	9-2
C.	Ship Control Systems	9-6
D.	Ship Safety Systems	9-9
<b>Section 10</b>	<b>Computer Systems</b>	<b>10-1</b>
A.	General	10-1
B.	Approval of system and components	10-5
C.	System categories	10-6
D.	Requirements on development and certification of computer-based system	10-6
E.	Requirements on maintenance of computer-based systems	10-13
F.	Management of change	10-14
G.	Technical requirements on computer-based systems	10-17
<b>Section 11</b>	<b>Lighting and Socket-Outlets</b>	<b>11-1</b>
A.	General	11-1

	B.	Lighting Installations . . . . .	11-1
	C.	Socket-Outlets . . . . .	11-2
<b>Section 12</b>		<b>Cable Network . . . . .</b>	<b>12-1</b>
	A.	Choice of Cables and Wires . . . . .	12-1
	B.	Determination of Conductor Cross-Sections . . . . .	12-2
	C.	Rating, Protection and Installation of Circuits . . . . .	12-5
	D.	Installation . . . . .	12-7
	E.	Requirements for Busbar Trunking Systems Intended for the Electrical Supply of Distribution Panels and Single Consumers . . . . .	12-15
<b>Section 13</b>		<b>Additional Rules for Electrical Main Propulsion Plants . . . . .</b>	<b>13-1</b>
	A.	General . . . . .	13-1
	B.	Drives . . . . .	13-2
	C.	Static Converter Installations . . . . .	13-3
	D.	Propulsion transformers . . . . .	13-5
	E.	Control Stations . . . . .	13-5
	F.	Ships' Mains . . . . .	13-6
	G.	Control and Regulating . . . . .	13-6
	H.	Protection of the Plant . . . . .	13-7
	I.	Measuring, Indicating, Monitoring and Operating Equipment . . . . .	13-8
	J.	Cables and Cable Installation . . . . .	13-11
	K.	Construction Supervision, Testing and Trials . . . . .	13-11
	L.	Additional Rules for Ships with Redundant Propulsion Systems (RP1x%, RP2x% or RP3x%) . . . . .	13-13
<b>Section 14</b>		<b>Additional Rules for Passenger Vessels . . . . .</b>	<b>14-1</b>
	A.	General . . . . .	14-1
	B.	Installation of Electrical Equipment . . . . .	14-1
	C.	Electrical Power Supply Systems . . . . .	14-2
	D.	Control, Monitoring and Ship's Safety Systems . . . . .	14-5
	E.	Lighting . . . . .	14-11
	F.	Cable Network . . . . .	14-12
<b>Section 15</b>		<b>Additional Rules for Tankers . . . . .</b>	<b>15-1</b>
	A.	General . . . . .	15-1
	B.	Oil Tankers, Cargo Flash Point above 60 °C . . . . .	15-3
	C.	Oil Tankers, Cargo Flash Point 60 °C or below . . . . .	15-3
	D.	Liquefied Gas Tankers . . . . .	15-4
	E.	Chemical Tankers . . . . .	15-4
<b>Section 16</b>		<b>Additional Rules for Ships for the Carriage of Motor Vehicles . . . . .</b>	<b>16-1</b>
	A.	Scope . . . . .	16-1
	B.	Protection Areas . . . . .	16-1
	C.	Ventilation . . . . .	16-1
	D.	Fire Alarm System . . . . .	16-2
	E.	Indicating and Monitoring Systems for Shell Doors . . . . .	16-2
	F.	Additional Requirements for the Illumination on Ro-Ro Passenger Vessels . . . . .	16-3
	G.	Installation of Electrical Equipment in Protection Areas . . . . .	16-4
	H.	Permissible Electrical Equipment . . . . .	16-4
	I.	Requirements for Spaces intended for Carriage of Motor Vehicles with compressed Natural Gas in their Tanks for their own Propulsion as Cargo . . . . .	16-6

---

<b>Section 17</b>	<b>Additional Rules for Ships for the Carriage of Dangerous Goods</b>	<b>17-1</b>
A.	Scope	17-1
B.	References to other Rules	17-1
C.	Classes of Dangerous Goods	17-1
D.	Hazardous Areas and Permitted Electrical Equipment	17-2
E.	Installation of Electrical Systems in Hazardous Areas	17-6
F.	Certification if Installations Not Conform to the above Provisions	17-6
G.	Fire Pumps	17-7
H.	Alternative Electrical Power Supply for Ships Intended for the Carriage of Packaged Irradiated Nuclear Fuel, Plutonium and High-level Radioactive Wastes	17-7
<b>Section 18</b>	<b>Additional Rules for Bulk Carriers and Single Hold Cargo Ships other than Bulk Carriers</b>	<b>18-1</b>
A.	General	18-1
B.	Water Level Detectors	18-1
<b>Section 19</b>	<b>Additional Rules for Ships with Ice Class</b>	<b>19-1</b>
A.	Ships with Ice Class	19-1
<b>Section 20</b>	<b>Electrical Equipment</b>	<b>20-1</b>
A.	Electrical Machinery	20-1
B.	Transformers and Reactance Coils	20-5
C.	Capacitors	20-7
D.	Storage Batteries, Chargers and Uninterruptible Power Supplies (UPS)	20-7
E.	Switchgear and Protection Devices	20-10
F.	Cables and Insulated Wires	20-12
G.	Cable Penetrations and Fire Stops	20-14
H.	Installation Material	20-14
I.	Lighting Fixtures	20-14
J.	Electrical Heating Equipment	20-15
<b>Section 21</b>	<b>Test</b>	<b>21-1</b>
A.	General	21-1
B.	Examinations of Technical Documentation	21-1
C.	Tests in the Manufacturer's Works	21-1
D.	Tests on Board	21-3
E.	Type Approvals	21-5
<b>Section 22</b>	<b>Spare Part</b>	<b>22-1</b>
<b>Section 23</b>	<b>Additional Rules for Storage of Electrical Power</b>	<b>23-1</b>
A.	General	23-1
B.	Definitions	23-1
C.	Further rules and standards to be considered	23-1
D.	Documents to be submitted	23-2
E.	Battery system	23-5
F.	Class Notation SEP (Power)	23-10
G.	Class notation SEP(Propulsion)	23-17
<b>Section 24</b>	<b>Cyber Resilience of Ships</b>	<b>24-1</b>
A.	Introduction	24-1
B.	Definitions	24-4
C.	Goals and organization of requirements	24-6
D.	Requirements	24-7
E.	Demonstration of compliance	24-36

---

F.	Risk assessment for exclusion of CBS from the application of requirements . . . .	24-39
G.	Summary of actions and documents . . . . .	24-41
H.	Summary of requirements and documents . . . . .	24-42
<b>Section 25</b>	<b>Cyber Resilience of On-board Systems and Equipment . . . . .</b>	<b>25-1</b>
A.	General . . . . .	25-1
B.	Security Philosophy . . . . .	25-4
C.	Documentation . . . . .	25-5
D.	System Requirements . . . . .	25-7
E.	Secure Development Lifecycle Requirements . . . . .	25-12
F.	<b>Demonstration of compliance</b> . . . . .	25-14
<b>Annex A</b>	<b>Additional Requirements for Low Voltage Shore Connection . . . . .</b>	<b>A-1</b>
A.	General . . . . .	A-1
B.	Shore Installation . . . . .	A-4
C.	Ship to Shore Connection and Interface . . . . .	A-5
D.	Ship Installation . . . . .	A-7
E.	Testing and Trials . . . . .	A-10
<b>Annex B</b>	<b>Requirements for Additional Generator . . . . .</b>	<b>B-1</b>
A.	General . . . . .	B-1
B.	Temporary Additional Generator . . . . .	B-1
C.	Permanent Additional Generator . . . . .	B-3

*This page intentionally left blank*

## Section 1 General Requirements and Guidance

A.	General . . . . .	1-1
B.	Definitions . . . . .	1-1
C.	Documents . . . . .	1-6
D.	Further Rules and Standards to be Considered . . . . .	1-10
E.	Ambient Conditions . . . . .	1-11
F.	Operating Conditions . . . . .	1-14
G.	Power Supply Systems . . . . .	1-15
H.	Voltages and Frequencies . . . . .	1-16
I.	Visual and Acoustical Signalling Devices . . . . .	1-16
J.	Materials and Insulation . . . . .	1-17
K.	Protective Measures . . . . .	1-18

### A. General

#### 1. Scope and application

1.1 These Construction Rules apply to electrical and electronic equipment on seagoing ships, classified by Biro Klasifikasi Indonesia (BKI).

1.2 Versions deviating from the Construction Rules may be approved if they have been tested for suitability and accepted as equivalent by BKI.

1.3 BKI reserve the right to specify additional requirements to the Construction Rules where these are related to new systems or installations or where they are necessary because of new knowledge or operating experience.

Deviations from the Construction Rules may be approved where there are special reasons.

1.4 For ships operating in Indonesian waters only, [Peraturan Kapal Domestik \(Pt.8, Vol.1\)](#) are to be applied.

#### 2. Design

Electrical installations shall be designed so that:

- the maintaining of normal operational and habitable conditions provided on board will be ensured without recourse to the emergency source of electrical power
- the operation of the equipment required for safety will be ensured under various emergency conditions
- the safety of passengers, crew and ship from electrical hazards will be ensured.

### B. Definitions

For the purpose of these Rules the definitions in [Table 1.1](#) are applied.

**Table 1.1: Definition**

No.	Item	Description
1	<b>Power supply installations</b>	The power supply installations comprise all installations for the generating, conversion, storage and distribution of electrical energy.
2	<b>Essential equipment<sup>1</sup></b>	1. Essential for ship operation are all main propulsion plants. 2. Essential are the auxiliary machinery and plants, which: <ul style="list-style-type: none"> <li>— are necessary for the propulsion and manoeuvrability of the ship</li> <li>— are necessary for the navigation of the ship</li> <li>— are required for maintaining ships's safety</li> <li>— are required to maintain the safety of human life at sea as well as</li> <li>— equipment according to special Characters of Classification and Class Notations</li> </ul> 3. The essential equipment is subdivided into: <ul style="list-style-type: none"> <li>— primary essential equipment</li> <li>— secondary essential equipment</li> </ul>
3	<b>Primary essential equipment</b>	Primary essential equipment is equipment according to <b>Essential equipment</b> point 2 which has to be in uninterrupted operation. It comprises e.g.: <ul style="list-style-type: none"> <li>— generator units supplying primary essential equipment</li> <li>— steering gear plant</li> <li>— fuel oil supply units including viscosity control equipment</li> <li>— lubricating oil pumps</li> <li>— cooling water/cooling media pumps</li> <li>— charging air blowers</li> <li>— electrical equipment for oil firing equipment</li> <li>— electrical equipment for the thermal oil systems</li> <li>— hot and warm water generation plants</li> <li>— hydraulic pumps for primary essential equipment</li> <li>— controllable pitch propeller installation</li> <li>— electrical main propulsion plants</li> <li>— azimuth drives as sole propulsion equipment</li> <li>— main steam plants</li> <li>— adjusting, control and safety devices/systems for primary essential equipment</li> <li>— monitoring equipment for primary essential equipment</li> </ul>
4	<b>Secondary essential equipment</b>	Secondary essential equipment is equipment according to <b>Essential equipment</b> point 2 which has not to be in uninterrupted operation for a short time. It comprises e.g.: <ul style="list-style-type: none"> <li>— starting installations for auxiliary and main engines</li> <li>— starting and control air compressor</li> <li>— engine and boiler room ventilation fans</li> <li>— fuel oil treatment units</li> <li>— fuel oil transfer pumps</li> <li>— lubrication oil treatment units</li> <li>— lubrication oil transfer pumps</li> <li>— heavy fuel oil heaters</li> <li>— bilge and ballast pumps</li> <li>— ballast water treatment systems</li> </ul>



Table 1.1: Definition (continued)

No.	Item	Description
4	<b>Secondary essential equipment (cont.)</b>	<ul style="list-style-type: none"> <li>– heeling compensation systems</li> <li>– fire pumps and fire-fighting plant</li> <li>– hydraulic pumps for secondary essential equipment</li> <li>– electrical equipment for auxiliary steam plants</li> <li>– transverse thrusters, if they auxiliary equipment</li> <li>– anchor windlass</li> <li>– ventilation fans for hazardous areas</li> <li>– turning gear for main engines</li> <li>– generators supplying secondary essential equipment, only if this equipment is not supplied by generators as under <b>Primary essential equipment</b></li> <li>– lighting system</li> <li>– position and navigating lights, aids and signal equipment</li> <li>– navigational appliances and navigational systems</li> <li>– fire detection and alarm systems</li> <li>– internal safety communication equipment</li> <li>– bulkhead door closing equipment</li> <li>– bow and stern ramps as well as shell openings</li> <li>– control monitoring and safety systems for cargo containment systems</li> <li>– adjusting, control and safety devices/systems for secondary essential equipment</li> <li>– monitoring equipment for secondary essential equipment</li> </ul>
5	<b>Non-essential equipment</b>	Non-essential equipment is equipment which is not listed in <b>Essential equipment</b> respectively which does not fit into the definition according to <b>Essential equipment</b> .
6	<b>Emergency consumers</b>	Emergency consumers are mandatory consumers which, after breakdown of the main energy supply, shall be fed by the emergency energy supply.
7	<b>Electric network</b>	An electric network comprises all equipment/installations connected together at the same rated voltage.
8	<b>Isolated electric network</b>	This term refers to a system in which a conductor or the neutral is not connected to the ship's hull in normal operation. If it is earthed via measuring or protective devices with a very high impedance, the system is likewise deemed to be isolated.
9	<b>Isolated electric network</b>	This is a system in which the neutral is connected to the ship's hull in normal operation.
10	<b>Rated voltage of an electric network</b>	The rated voltage UN (Root Mean Square value RMS) of a system is a characteristic system parameter to which specific characteristics of the connected facilities and the limit and test values of the system and of the facilities are referred.
11	<b>Safety voltage</b>	Safety voltage is a protection provision and consists of a circuit with rated voltage not exceeding 50 V AC, operated unearthed and isolated safely from supply circuits exceeding 50 V.
12	<b>Low-voltage systems</b>	Are systems operating with rated voltages of more than 50 V up to 1000 V inclusive and with rated frequencies of 50 Hz or 60 Hz, or direct-current systems where the maximum instantaneous value of the voltage under rated operating conditions does not exceed 1500 V.

**Table 1.1: Definition (continued)**

No.	Item	Description
13	<b>Medium-voltage systems</b>	Are systems operating with rated voltages of more than 1 kV and up to 17,5 kV inclusive and with rated frequencies of 50 Hz or 60 Hz, or direct-current systems, with the maximum instantaneous value of the voltage under rated operating conditions over 1500 V.
14	<b>Machinery spaces</b>	Machinery spaces are spaces in which machines and equipment are installed and which are accessible only to authorized persons, e.g. engine rooms.
15	<b>Wet operating spaces</b>	Wet operating spaces are spaces in which facilities may be exposed to moisture, e.g. main engine rooms.
16	<b>Dry operating spaces</b>	Dry operating spaces are spaces in which no moisture normally occurs, e.g. engine control rooms.
17	<b>Locked electrical spaces</b>	Locked electrical spaces are spaces which are provided with lockable doors and are intended solely for the installation of electrical equipment such as switch gear, transformers, etc. They have to be constructed as dry spaces.
18	<b>Category A machinery spaces</b>	Category A machinery spaces are spaces which contain internal combustion engines used for the main propulsion or other purposes and having a total power output of at least 375 kW, or which contain an oil-fired boiler or an oiltreatment plant. The trunks to such spaces are included.
19	<b>Hazardous areas</b>	<p>Hazardous areas are areas in which an explosive atmosphere in dangerous quantity is liable to occur owing to local and operating conditions. Hazardous areas are divided into zones depending on the probability that an explosive atmosphere may occur.</p> <p><b>Subdivision into zones</b></p> <p>Zone 0 comprises areas in which an explosive gas atmosphere is present either permanently or for long periods.</p> <p>Zone 1 comprises areas in which an explosive gas atmosphere is liable to occur occasionally.</p> <p>Zone 2 comprises areas in which an explosive gas atmosphere is liable to occur only rarely, and then only for a brief period (extended hazardous areas).</p>
20	<b>Fire sections</b>	Zone between boundaries of type A for protection against propagation of fire according to the arrangements of SOLAS (passenger ships)
21	<b>Fire subdivisions</b>	Zone between boundaries for protection against propagation of fire according to the arrangements of SOLAS (passenger and cargo ships).
22	<b>Flame-retardation of individual cables</b>	Single cables and wires are considered to be flame-retardant if they meet the test requirements of IEC publication 60332-1-2:2004+AMD1:2015 regarding flame propagation
23	<b>Flame-retardation of cable bunches</b>	Cable bunches and wire bunches are considered flame-retardant if they are flame retardant as single cables, and laid bundled, meet the requirements of IEC publication 60332-3-22:2018 category A with regard to flame propagation.
24	<b>Fire-resistant cables</b>	Fire-resistant cables are those which under the influence of flames demonstrate function sustaining characteristics for a certain time, e.g. 3 hours, and meet the IEC publication 60331 test requirements.

**Table 1.1: Definition (continued)**

No.	Item	Description
25	<b>Cable bundles</b>	Arrangement of two or more cables laid parallel and directly contiguous.
26	<b>Systems</b>	Systems contain all equipment necessary for monitoring, control and safety including the input and output devices. Systems cover defined functions including behaviour under varying operating conditions, cycles and running.
27	<b>Protection devices</b>	Protective devices detect actual values, activate alarms in the event of limit value infringement and prevent machinery and equipment being endangered. They automatically initiate curative measures or calls for appropriate ones.
28	<b>Safety devices</b>	Safety devices detect critical limit-value infringements and prevent any immediate danger to persons, ship or machinery.
29	<b>Safety systems</b>	Combination of several safety devices and/or protection devices into one functional unit.
30	<b>Alarms</b>	An alarm gives optical and acoustical warning of abnormal operating conditions.
31	<b>Power electronics</b>	All equipment and arrangements for generation, transformation, switching and control of electrical power by the use of semi-conductor components.
32	<b>Equipment of power electronics</b>	All equipment which directly affect the flow of electrical energy; consist of the functional wired semiconductor elements together with their protection and cooling devices, the semiconductor transformers or inductors and the switchgear in the main circuits.
33	<b>International Protection (IP)</b>	Degree of protection provided against the intrusion of solid objects including body parts like hands and fingers, dust, accidental contact and water.
34	<b>Short circuit calculation</b>	Are calculation needed to determine the required switching capabilities of the circuit breakers, the breaking capabilities of fuses and the dynamical strength of busbars and other current carriers.
35	<b>Electromagnetic Compatibility (EMC)</b>	Capability of an electric system to neither disturb or be disturbed via radiation or transferred through the connection cable. It also includes disturbance by signals in cables not connected to the disturbed unit but signals running through cables parallel to cables of the disturbed unit.
36	<b>Engineer's call</b>	The duty alarm system sends alarms to the responsible persons/Engineer in case of incorrect situations whenever the machinery spaces are unattended.
37	<b>Voyage Data Recorder (VDR)</b>	Maintains continuously sequential records of preselected data items relating to the status and output of the ship's equipment, and command and control of the ship, such as date and time, ship's position, heading, speed, conversations in the Bridge, other ship status, etc. to investigate causes of an incident.
38	<b>Control Station</b>	Are those spaces which are: <ol style="list-style-type: none"> <li>1. Main navigational equipment includes, in particular, the steering stand and the compass, radar and direction-finding equipment are located.</li> <li>2. Where in the regulations of chapter II-2 relevant to fixed fire-extinguishing systems there are no specific requirements for the centralization within a control station of major components</li> </ol>

**Table 1.1: Definition (continued)**

No.	Item	Description
38	<b>Control Station (cont.)</b>	of a system, such major components may be placed in spaces which are not considered to be a control station. 3. Spaces containing, for instance, the following battery sources should be regarded as control stations regardless of battery capacity: <ul style="list-style-type: none"> <li>— emergency batteries in separate battery room for power supply from black-out till start of emergency generator,</li> <li>— emergency batteries in separate battery room as reserve source of energy to radio-telegraph installation,</li> <li>— batteries for start of emergency generator,</li> <li>— and, in general, all emergency batteries required in pursuance of Reg. II-1/42 or Reg. II-1/43. (MSC/Circ. 1120)</li> </ul> 4. Steering gear rooms containing an emergency steering position are not considered to be control stations.  See also <a href="#">Guidance for Code and Convention Interpretations (Pt.1, Vol.Y) Sec.11.SC17</a>
39	<b>Black-out</b>	The situation where the main and auxiliary machinery installations, including the main power supply, are out of operation but the services for bringing them into operation (e.g. compressed air, starting current from batteries etc.) are available
40	<b>Dead ship</b>	The situation where the complete machinery plant including the main source of electrical power are out of operation and auxiliary energy as compressed air, starting current from batteries etc. are not available for the restoration of the main power supply, for the restart of the auxiliaries and for the startup of the propulsion plant. It is however assumed that the equipment for start-up of the emergency diesel generator is ready for use
<sup>1</sup> For ships with equipment according to special Characters of Classification and Notations certain type-specific plants may be classed as essential equipment.		

## C. Documents

### 1. Documents to be submitted for approval

#### 1.1 New buildings

**1.1.1** The drawings and documents listed in [Table C.1.1.2](#) and [Table 1.3](#) are to be submitted for examination at a sufficiently early date to ensure that they are approved and available to the Surveyor at the beginning of manufacture or installation of the electrical equipment.

**1.1.2** The drawings of switchgear and control systems are to be accompanied by parts lists indicating the manufacturers and characteristics of the electrical components, circuit diagrams together with descriptions, where these constitute a necessary aid to understanding.

The drawings and documents shall make it clear that the requirements set out in this Rules have been complied with.

**Table 1.2: Documents subject to approval relating to electrical equipment**

Serial No.	Documents	Basic documentation	Additional documents							
		Ships in general	Passenger ships	Ro/Ro-passenger ships	Ro/Ro-cargo ships	Ships with refrigerating installation (RIC, RCP)	Ships for the carriage of dangerous cargoes	Tankers	Oil-chemical fighting ships	Bulk carriers
<b>1</b>	<b>Forms</b>									
1.1	Form F.21.2.40	X								
1.2	Form F.21.2.12, copies of certificate of conformity			X	X		X	X	X	X
<b>2</b>	<b>Power-supply equipment</b>									
2.1	Electrical plant, power generating and distribution (general layout drawing)	X								
2.2	Generators, UPS units, batteries with maintenance schedule, transformers	X								
2.3	Spaces with an explosion hazard with details of installed equipment			X	X			X	X	
2.4	Short-circuit calculation, where total generators output >500 kVA	X								
2.5	Electrical power balance (main and emergency supply)	X								
2.6	Protection coordination study with all values >3000 kVA	X								
2.7	Main switchgear	X								
2.8	Emergency switchgear	X								
2.9	Main distribution boards	X								
2.10	Refrigerating installation: switchgear, monitoring, control and design					X				
2.11	Main cableways		X	X						
2.12	Main cableways for medium-voltage systems	X								
2.13	Bulkhead/deck penetrations A60	X								
2.14	Cable layout/list	X								
2.15	Harmonic distortion calculation, if applicable 1	X								
<b>3</b>	<b>Manoeuvring equipment</b>									
3.1	Steering gear drive and control systems	X								
3.2	Rudder propeller and lateral thrust system	X								
3.3	Controllable pitch propeller system	X								
<b>4</b>	<b>Lighting</b>									
4.1	Lighting arrangement	X								
4.2	Emergency lighting arrangement	X								
4.3	Additional emergency lighting arrangement and facilities				X					
4.4	Electric operated LLL-system			X	X					
<b>5</b>	<b>Starting, control and monitoring equipment</b>									
5.1	Monitoring systems for machinery	X								
5.2	Safety devices/safety systems for machinery	X								
5.3	Electrical starting arrangements for auxiliary and main engines	X								
5.4	Controls and adjustments for essential equipment/drive installations	X								
5.5	Ballast water treatment system	X								
<b>6</b>	<b>Ship's safety devices</b>									
6.1	General alarm systems	X								
6.2	Technical officer's alarm system	X								

**Table 1.2: Documents subject to approval relating to electrical equipment (continued)**

Serial No.	Documents	Basic document- ation	Additional documents							
		Ships in general	Passenger ships	Ro/Ro-passenger ships	Ro/Ro-cargo ships	Ships with refrigerating installation (RIC, RCP)	Ships for the carriage of dangerous cargoes	Tankers	Oil-chemical fighting ships	Bulk carriers
6.3	Navigation and signalling lights, power supply and monitoring system	x								
6.4	Fire detection and alarm systems	x								
6.5	CO <sub>2</sub> alarm system	x								
6.6	Watertight doors operating and position monitoring system		x	x						
6.7	Fire doors operating and position monitoring system		x	x						
6.8	Control and monitoring systems for shell doors, gates and Ro/Ro decks			x	x					
6.9	Emergency shut-off facilities	x								
6.10	Tank level indicators, alarms, shut-off facilities						x	x		
6.11	Gas detector systems						x	x		
6.12	Inert gas system						x			
6.13	Fixed water-based local application fire-fighting systems (FWBLAFFS)	x								
6.14	Water ingress detection system									x
<b>7</b>	<b>Communication systems</b>									
7.1	Public address system	x								
7.2	Important intercommunication systems	x								
<b>8</b>	<b>Computer systems</b>									
8.1	System configuration	x								
8.2	Software version	x								
<b>9</b>	<b>Electrical propulsion plants</b>									
9.1	Propulsion motors	x								
9.2	Static converters	x								
9.3	Control, adjustment, monitoring	x								
9.4	Functional description for Class Notation RP ..%	x								
9.5	FMEA for Class Notation RP ..%	x								
9.6	Trial program	x								
<b>10</b>	<b>Medium voltage installations</b>									
10.1	Trial program for switchgears	x								

<sup>1</sup> for ship having non-linear loads that contribute higher harmonics current in power system e.g. voltage and frequency converter

- 1.1.3 Any non-standard symbols used are to be explained in a key.
- 1.1.4 All documents are to be indicated with the hull number and the name of the shipyard.
- 1.1.5 All documentation shall be submitted in Bahasa Indonesia or English.
- 1.1.6 Forms “Details of the scope and type of electrical plant (F.21.2.40)” and “Construction of electrical equipment in hazardous areas (F.21.2.12)” are to be submitted for each ship as mentioned in [Table 1.2](#). Copies of Certificates of conformities of all installed electrical equipment for hazardous areas shall be part of the F.21.2.12.
- 1.1.7 BKI reserve the right to demand additional documentation if that submitted is insufficient for an assessment of the installation.

## 1.2 Modifications and extensions

Major modifications to the electrical installations of ships under construction or in service are subject to approval. The relevant documents are to be submitted in ample time prior to the execution of the work.

## 2. Documents to be kept on board

When the ship is commissioned or following major modifications and extensions of the electrical equipment, at least the documents subject to approval, specified in C. and showing the final arrangement of the electrical equipment, are to be supplied on board. The documents are to be marked with the name or the yard number of the ship, the name of the yard and the date of preparation of the documents.

**Table 1.3: Electrical equipment and cables subject to the approval and test**

No.	Electrical equipment, components and Cables	Drawing Approval	Type Approval	Test at Manufacturer	Test on board	Scope of tests/ Referances
<b>1</b>	<b>Electrical machines</b>					
1.1	Generators and motors for electric propulsion plants	x <sup>5</sup>		x	x <sup>3</sup>	Guidance Pt.1, Vol.W Section 3.T
1.2	Generators P ≥ 100 kVA <sup>1</sup>	x <sup>5</sup>		x	x <sup>3</sup>	
1.3	Motors P ≥ 100 kW <sup>1</sup>	x <sup>5</sup>		x		
1.4	Transformers P ≥ 100 kVA	x <sup>6</sup>		x		
1.5	Autotransformers P ≥ 100 kVA			x		
<b>2</b>	<b>Power electronics</b>					
2.1	Electric propulsion plants, see Section 13.K	x		x	x <sup>3</sup>	Section 6.G
2.2	Essential equipment P ≥ 50 kW/ kVA			x	x <sup>3</sup>	
2.3	Battery charging P ≥ 2 kW	x		x	x <sup>3</sup>	
<b>3</b>	<b>Switchboards</b>					
3.1	Main switchboards	x		x		- Section 5.F,
3.2	Emergency switchboards	x		x		- Section 8.E
3.3	Switchboards for electric propulsion plants	x		x		- Checklist form F21.8.01
3.4	Switchboards for operation of equipment with Class Notation, e.g. cargo-refrigerating systems RIC			x		
3.5	Distribution switchboards with connected power ≥ 500 kW			x		
3.6	Starters for motors in 1.3 above			x		
<b>4</b>	<b>Steam boilers and thermal oil systems</b>					
4.1	Starter and control			x		Section 5.H
<b>5</b>	<b>Electrical propulsion plants</b>			x	x <sup>3</sup> , x <sup>4</sup>	Section 13
<b>6</b>	<b>Computer systems</b>		x	x	x <sup>3</sup>	Section 10
<b>7</b>	<b>Cable network</b>				x <sup>2</sup>	
<b>8</b>	<b>Cable and accessories</b>					
8.1	Cables and insulated wires		x			- Guidance Pt.1, Vol.W Section 3.T,
8.2	Sealing compound and packing systems for bulkhead and deck penetrations		x			- Guidance for Marine Industry (Pt.1, Vol.AC) Sec.4 R-73
8.3	Busbar trunking systems for the installation		x			
8.4	Cable trays/protective casings made of plastic materials		x			- Guidance Pt.1, Vol.W Section 3.T, - Guidance for Marine Industry (Pt.1, Vol.AC) Sec.4 R-73
<b>9</b>	<b>Switchgear</b>					
9.1	Circuit-breakers, load switches, disconnect switches and fuses for direct connection to the main bus-bars or non-protected distribution busbars of main, emergency and propulsion switchboards		x			Section 5.H
9.2	Standardized switchgear units manufactured in series with reduced clearance and creepage distances, see Section 5, F.3.2		x			
<b>10</b>	<b>Generator/mains supply protection devices</b>					
10.1	Short-circuit protection		x			- Guidance Pt.1, Vol.W Section 3.T,
10.2	Overcurrent protection		x			- Section 4 of this Rules
10.3	Reverse-power protection		x			
10.4	Automatically synchronizing device		x			
10.5	Under frequency protection		x			
10.6	Over and under voltage protection		x			
10.7	Differential protection		x			
10.8	Earth fault monitoring		x			
<b>11</b>	<b>Steering gear and rudder-propeller systems</b>					
11.1	Input devices, e.g. Phase failure relays, Level sensors		x			Section 7.A
11.2	Steering gear control systems with all components important for the function, e.g. Steering mode selector switch, Follow up/ non-follow up control devices		x			
<b>12</b>	<b>Variable pitch propeller controls with all components important for the functioning</b>		x			
<b>13</b>	<b>Machinery control systems</b>					

**Table 1.3: Electrical equipment and cables subject to the approval and test (continued)**

No.	Electrical equipment, components and Cables	Drawing Approval	Type Approval	Test at Manufacturer	Test on board	Scope of tests/References
13.1	Open and closed loop control for speed and power of internal combustion engines (main and auxiliary engines) and electrical actuators		x			Section 9
13.2	Safety devices		x			
13.3	Safety systems		x			
<b>14</b>	<b>Control, monitoring and ship's safety systems</b>				x <sup>3</sup>	
14.1	Fire detection and alarm systems		x			- Section 9.C
14.2	Suction-type smoke detection systems		x			- Section 9.D
14.3	Loading instrument		x			- Section 7.G
14.4	Automatic stop devices and control units for heel compensation systems		x			
14.5	Flame detectors, remotely controlled valves, control electronics and fire detection systems for fixed water-based local application fire-fighting systems		x			
14.6	Combustion engine crankcase oil mist detection monitoring device/system		x			
<b>15</b>	<b>Storage batteries</b>				x <sup>3</sup>	
15.1	Monitoring, protection and management systems of battery systems		x			
<b>16</b>	<b>Power plants</b>				x <sup>3</sup>	
<b>17</b>	<b>For tankers</b>					
17.1	Tank level gauging equipment		x			Section 15
17.2	Tank level alarm equipment		x			
17.3	Overfill protection devices		x			
17.4	Tank pressure monitoring systems		x			
17.5	Required gas detectors and -systems		x			
<b>18</b>	<b>Water ingress detection system for bulk carriers</b>		x			Section 18
<b>19</b>	<b>Input devices and actuators for ships with RIC Class Notation</b>		x			Rules Pt.1, Vol.VIII
<b>20</b>	<b>Electrically supplied LLL-systems</b>		x			
<b>21</b>	<b>Installations, applied by the rules for construction for automated and/or remotely controlled systems,</b>		x			Rules Pt.1, Vol.VII Section 7.E
<b>22</b>	<b>Electric heater (fuel oil heating systems)</b>	x		x		Section 20.J

<sup>1</sup> Generators and motors for essential equipment, or if they are necessary for the preservation of the cargo/ship's safety, e.g. for Class Notation RIC, RCP, compressors for gas tanker, circulating pumps for sea operation etc. P ≥ 100 kW/ kVA  
<sup>2</sup> During construction, see Section 21.D.2  
<sup>3</sup> During dock trials, see Section 21.D.3  
<sup>4</sup> Sea trials, see Section 21.D.4  
<sup>5</sup> Only applicable for generators and motors of 100 kVA and above  
<sup>6</sup> Only applicable for high voltage electrical installations

## D. Further Rules and Standards to be Considered

### 1. Rules and Guidelines

Further Rules and Guidelines of BKI mentioned in this Rules are to be observed

### 2. National Regulations

If necessary, beside of the BKI's Construction Rules, National Regulations are to be observed as well.

### 3. International Regulation and Codes

**3.1** Where the requirements for electrical equipment and facilities are not laid down in these Rules, decision shall be made, wherever necessary, regarding the use of other regulations and standards. These include e.g. IEC publications, especially all IEC 60092 publications.

**3.2** The provisions of the "International Convention for the Safety of Life at Sea (SOLAS)" are taken into account in these Rules, insofar as these affect electrical installations.

**3.3** For interpretation of International Convention and Code, [Guidance for Code and Convention Interpretation \(Pt.1, Vol.Y\)](#) is to be observed



## E. Ambient Conditions

### 1. Environmental effects

1.1 The selection, layout and arrangement of all shipboard machinery, equipment and appliances shall be such as to ensure faultless continuous operation. Therefore, the manufacturer/ supplier shall be informed by the user about the expected environmental conditions. The requirements are specified in [Table 1.4](#), [Table 1.5](#) and [Table 1.6](#).

1.2 Products are classified according to their applications into the environmental categories, as state in [Table 1.6](#).

1.3 Care has to be taken of the effects on the electrical installations caused by distortions of the ship's hull.

1.4 For ships intended for operation only in specified zones, BKI may approve deviating ambient conditions.

1.5 Ambient temperatures for electrical equipment in areas other than machinery spaces.

**Table 1.4: Inclinations**

Equipment, components	Angle of Inclination [°] <sup>2</sup>			
	athwartships		longitudinally	
	static	dynamic	static	dynamic
Main engines and auxiliary machinery	15	22,5 10 s <sup>4</sup>	5	7,5
Ship's safety equipment, including, for example, emergency source of power, emergency fire pumps and other drives	22,5 <sup>3</sup>	22,5 <sup>3</sup>	10	10
Switchgear, electric and electronic equipment <sup>1</sup> , remote controls		10 s <sup>4</sup>		
<sup>1</sup> no unintended switching operations or functional changes shall occur <sup>2</sup> inclinations may occur simultaneously athwartships and longitudinally <sup>3</sup> on ships for the carriage of liquefied gases and chemicals, the emergency power supply shall also remain operational with the ship flooded up to a maximum final athwartship inclination of 30°. See <a href="#">Rules for Ships Carrying Liquefied Gas in Bulk (Pt.1, Vol.IX) Sec.2.7.2.2</a> and <a href="#">Rules for Ships Carrying Dangerous Chemicals in Bulk (Pt.1, Vol.X) Sec.2.9.3.2</a> . See also the <a href="#">Guidance for Code and Convention Interpretation (Pt.1, Vol.Y) Section 5, SC 290</a> <sup>4</sup> rolling periods				

**Table 1.5: Water temperature**

Coolant	Temperature
Seawater	+ 32 °C <sup>1</sup>
<sup>1</sup> BKI may approve lower water temperatures for ships with restricted operational areas	

**Table 1.6: Environmental conditions / environmental categories**

Environmental Category	Environmental Conditions						Comments
	Closed Area			Open Deck Area			
	Temperature	relative Humidity	Vibrations	Temperature	relative Humidity	Vibrations	
A	0 °C to +45 °C	to 100%	0,7 g				For general applications, except category B, C, D, F, G, H.
B	0 °C to +45 °C	to 100%	4 g				For application at a higher level of vibration strain.
C	0 °C to +55 °C	to 100%	0,7 g				For application at a higher degree of heat.
D	0 °C to +55 °C	to 100%	4 g				For application at a higher degree of heat and a higher level of vibrations strain.
E	0 °C to +40 °C	to 80%	0,7 g				For use in air-conditioned areas. With BKI's special consent only.
F				-25 °C to +45 °C	to 100%	0,7 g	For application when additional influences of salt mist and temporary inundation are to be expected.
G				-25 °C to +45 °C	to 100%	2,3 g	For use on masts, with the additional influence of salt mist.
H	In accordance with manufacturer's specifications						The provisions contained in the Certificates shall be observed.

**1.5.1** Where electrical equipment is installed within environmentally controlled spaces the ambient temperature for which the equipment is to be suitable may be reduced from 45 °C and maintained at a value not less than 35 °C provided:

- the equipment is not for use for emergency power supply (see [Section 3.C](#)) and is located outside of the machinery space(s)
- temperature control is achieved by at least two cooling units so arranged that in the event of loss of one cooling unit, for any reason, the remaining unit(s) is capable of satisfactorily maintaining the design temperature
- the equipment is able to be initially set to work safely within a 45°C ambient temperature until such a time that the lesser ambient temperature may be achieved; the cooling equipment is to be rated for a 45°C ambient temperature
- acoustic and optical visual alarms are provided, at a continually manned control station, to indicate any malfunction of the cooling units

**1.5.2** In accepting a lesser ambient temperature than 45 °C, it is to be ensured that electrical cables for their entire length are adequately rated for the maximum ambient temperature to which they are exposed along their length.

**1.5.3** The equipment used for cooling and maintaining the lesser ambient temperature is to be classified as a secondary essential service, in accordance with [Table 1.1](#).

## 2. Vibrations

### 2.1 General

**2.1.1** Electrical machinery and appliances are normally subjected to vibration stresses. On principle their design, construction and installation shall consider these stresses.

The faultless long-term operation of individual components shall not be impaired by vibration stresses.

**2.1.2** Where an electrical machine or device generates vibrations when in operation, the intensity of the vibration shall not exceed defined limits. The purpose is to protect the vibration exciter themselves, and the connected assemblies, peripheral equipment and hull components, from excessive vibration stresses liable to cause premature failures or malfunctions.

**2.1.3** The following provisions relate to vibrations in the 2 - 300 Hz frequency range. They are to be applied in analogous manner to higher frequency vibrations.

**2.1.4** On principle investigation of vibration shall be carried out over the whole load and speed range of the vibration exciter.

## **2.2 Assessment**

**2.2.1** Assessment is based on the criteria laid down in the [Rules for Machinery Installations \(Pt.1, Vol.III\) Sec.1.C.2.2.](#)

**2.2.2** Assessment of the vibration loads on electrical machines and equipment is based on the areas defined in [Rules for Machinery Installations \(Pt.1, Vol.III\) Sec.1.C.2.](#) It concerns vibrations which are introduced from the environment into electrical machines and equipment as well as vibrations generated from these components themselves.

**2.2.3** For the assignment of a vibration value to a particular area is on principle the synthesis value, not an individual harmonic component relevant.

**2.2.4** Electrical machines and equipment for use on board of ships shall be designed at least for a vibration load corresponding to area A (0,7g). With the agreement of BKI, a lower endurance limit may be permitted in exceptional cases. In such cases, suitable countermeasures (vibration damping, etc.) shall be taken to compensate for the increased sensitivity.

**2.2.5** If an electrical machine or equipment generates mechanical vibrations when in service, e.g. because it is out of balance, the vibration amplitude measured on the machine or the equipment on board shall not lie outside area A. For this evaluation, reference is made only to the self-generated vibration components. Area A may only be utilized if the loading of all components, with due allowance for local excess vibration, does not impair reliable long-term operation.

**2.2.6** In positions exposed to particularly severe stresses, electrical machines and appliances may be loaded outside area A (0,7g). In this case the user has to inform the manufacturer about the operational requirements and the machines or the equipment shall be designed appropriately.

**2.2.7** Electrical appliances and equipment operating in positions where they are exposed to severe vibration loads, e.g. in the immediate vicinity of reciprocating machines, and in steering gear compartments, shall be designed for these severe vibration loads. The limit of area C (4g) shall, however, not be exceeded. Lower design parameters can be accepted subject to proof of lower vibration loading in service.

**2.3** Permissible torsional vibration stress, see [Rules for Machinery Installations \(Pt.1, Vol.III\) Sec.16.C.](#)

## **2.4 Proofs**

**2.4.1** A vibration test in accordance with the [Guidance for Approval and Type Approval of Materials and Equipment for Marine Use \(Pt.1, Vol.W\)](#) is deemed to constitute proof. The test (limit A respectively C) shall conform to the operational requirements.

**2.4.2** Other forms of proof, e.g. calculations, may be accepted upon agreement with BKI.

## **2.5 Measurements**

Where such measures are justified, BKI reserve the right to demand that measurements be performed under operating or similar conditions. This applies both to proof of the vibration level and to the assessment of the self-generated exciter spectrum.

## F. Operating Conditions

### 1. Voltage and frequency variations

1.1 All electrical equipment shall be so designed that it works faultlessly during the voltage and frequency variations occurring in the normal operation. The variations indicated in Table 1.7 are to be used as a basis.

1.2 Unless otherwise stated in National or International standards, all equipment shall operate satisfactorily with the variations from it's rated value shown in Table 1.7, Table 1.8 and Table 1.9 on the following conditions:

- 1) For alternative current components, voltage and frequency variations shown in the Table 1.7 are to be assumed.
- 2) For direct current components supplied by DC generators or converted by rectifiers, voltage variations shown in the Table 1.8 are to be assumed.
- 3) For direct current components supplied by electrical batteries, voltage variations shown in the Table 1.9 are to be assumed.

1.3 Any special system, e.g. electronic circuits, whose function cannot operate satisfactorily within the limits shown in the Table shall not be supplied directly from the system but by alternative means, e.g. through stabilized supply.

**Table 1.7: Voltage and frequency variations for a.c. distribution systems**

Quantity in operation	Variations	
	permanent	transient
Frequency	±5 %	±10 % (5 sec)
Voltage	+6 %, -10 %	±20 % (1,5 sec)

**Table 1.8: Voltage variations for d.c. distribution systems**

Parameters	Variations
Voltage tolerance (continuous)	±10 %
Voltage cyclic variation deviation	5 %
Voltage ripple (a.c. r.m.s. over steady d.c. voltage)	10 %

**Table 1.9: Voltage variations for battery systems**

Systems	Variations
Components connected to the battery during charging <sup>1</sup>	+30 %, -25 %
Components not connected to the battery during charging	+20 %, -25 %

<sup>1</sup>Different voltage variations as determined by the charging/discharging characteristics, including ripple voltage from the charging device, may be considered

### 2. Mains quality

2.1 In systems without substantial static converter load and supplied by synchronous generators, the total voltage harmonic distortion shall not exceed 5%.

2.2 In systems fed by static converters, and systems in which the static converter load predominates, for single harmonics in permanence the limit values indicated in Fig. 1.1 apply.

2.3 If in particular cases, e.g. electrical propulsion plant systems, the above-mentioned limits are exceeded, the faultless function of all electrical devices shall be secured.

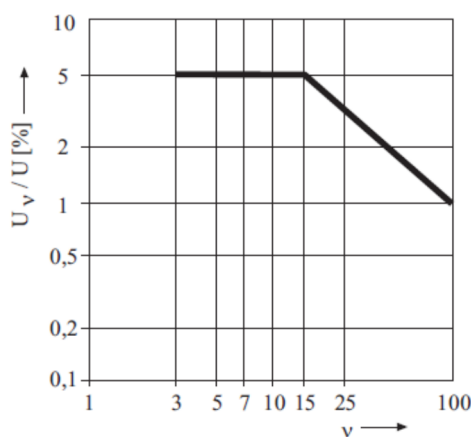

Figure 1.1: Limit values for the single harmonics in the supply voltage.  $U_v$  is the RMS value of the  $v$ -th order harmonic voltage

## G. Power Supply Systems

### 1. Low-voltage systems

The following systems are permitted in principle, for restrictions see 3.:

#### 1.1 For direct current and single-phase alternating current:

- 2 conductors, with one conductor earthed (1/N/PE)
- Single conductor with hull return (1/PEN)
- 2 conductors insulated from the ship's hull (2/PE)

#### 1.2 For three-phase current (alternating current):

- 4 conductors with neutral earthed, without hull return (3/N/PE)
- 3 conductors with neutral earthed, with hull return (3/PEN)
- 3 conductors insulated from the ship's hull (3/PE)

### 2. Medium-voltage systems

See [Section 8](#).

### 3. Hull return conduction/system earthing

3.1 The use of the ship's hull for return and/or system earthing is not permitted on tankers. For exceptions, see [Section 15](#).

3.2 Hull return is not permitted on ships of 1600 GT and over.

**3.3** Excepted from 3.1 and 3.2 are:

- intrinsically safe circuits where this is technically required
- circuits where it is necessary for safety reasons and in which the current will not exceed 5 A during normal operation and in case of failure
- hull return of currents for systems of active corrosion protection of shells
- hull return of currents or earthing of control and measuring cables for localized installations, e.g. starting and pre-heating installations of internal combustion engines
- hull return of currents come from insulation monitoring equipment and do not exceed 30 mA
- star point earthing of three-phase medium voltage installations, see Section 8, C.

**3.4** The connection of the return conductor to the hull shall be made somewhere easy to check and not in compartments with isolated bulkheads, e.g. chill/ cold rooms.

**4. Systems with earthed neutral**

If the selectivity is required in view of the shut-off of earth faults and additional current-limiting devices are mounted between the generator neutral-point and the ship’s hull, this shall not impair the selective shutoff of faulty circuits.

**5. Systems with non-earthed neutral**

**5.1** In non-earthed systems, the generator neutral points shall not be connected together.

**5.2** The insulation resistance of a distribution system without earthing of the system is to be monitored and displayed. For tankers, see also Section 15.C.

**H. Voltages and Frequencies**

The use of standardized voltages and frequencies is recommended. The maximum permitted rated mains voltages shall be as shown in Table 1.10.

**Table 1.10: Maximum permitted rated mains voltages**

17 500 V	for permanently installed power plants
500 V	a) for permanently installed power and control circuit
	b) for devices with plug-and-socket connections which are earthed either via their mounting or through a protective earth conductor
	c) the power supply to systems requiring special electric shock-prevention measures shall be provided via earth-leakage circuit breaker ≤ 30 mA (not applicable to essential equipment)
250 V (cont.)	a) for permanently installed lighting systems
	b) for permanently installed control, monitoring and ships safety systems
	c) for devices supplied via plug-and-socket and requiring special electric shock-prevention measures, the power supply is to take place via a protective isolating transformer, or the device shall be double-insulated
50 V Safety voltage	for portable devices for working in confined spaces where special electric shock-prevention measures are required

**I. Visual and Acoustical Signalling Devices**

**1.** The colours used for visual signalling devices shall conform to Table 1.11.

2. The use of monochrome screens is permissible, provided that clear recognition of the signals is guaranteed.
3. Reference is made to the IMO Resolution A.1021 (26) "Code on Alerts and Indicators", 2009.

**Table 1.11: Colour code for signalling devices**

Colour	Meaning	Explanation
Red	Danger or alarm	Warning of danger or a situation which requires immediate action
Yellow	Caution	Change or impending change of conditions
Green	Safety (normal operating and normal working conditions)	Indication of a safe situation
Blue	Instruction/information (specific meaning assigned according to the need in the case considered, e.g. operational readiness)	Blue may be given meaning which is not covered by the three above colours: red, yellow, and green
White	No specific meaning assigned (neutral)	General information, e.g. for confirmation

## J. Materials and Insulation

### 1. General

- 1.1 The materials used for electrical machines, switchgear cables and other equipment shall be resistant to sea air containing moisture and salt, seawater and oil vapours. They shall not be hygroscopic and shall be flame-retardant and self-extinguishing.
- 1.2 The evidence of flame-retardation shall be according to IEC publication 60092-101 or other standards, e.g. IEC publications 60695-11-10 or UL 94. Cables shall correspond to the IEC publication 60332-1.
- 1.3 The usage of halogen-free materials is recommended. Cables for passenger vessels, see [Section 14.F](#).
- 1.4 Units of standard industrial type may be used in areas not liable to be affected by salty sea air subject to appropriate proof of suitability.
- 1.5 Materials with a high tracking resistance are to be used as supports for live parts.

### 2. Clearance and creepage distances

- 2.1 The clearance and creepage distances for essential equipment are to be dimensioned as appropriate in accordance with IEC publication 60664-1 on the basis of the following values for:
  - rating operating voltage  $U_e$
  - overvoltage category III
  - pollution degree 3
  - insulation material group IIIa
- 2.2 For the clearance and creepage distances of main-busbars in main, emergency and propulsion switch-boards, see [Section 5.F.3](#).
- 2.3 Smaller clearance and creepage distances may be accepted by BKI provided less pollution is proved (degree of protection).

## K. Protective Measures

### 1. Protection against foreign bodies and water

1.1 The protection of electrical equipment against foreign bodies and water shall be appropriate to the particular place of installation.

The minimum degrees of protection for low-voltage switchgear are listed in [Table 1.12](#).

The grade of protection of the equipment shall also be ensured during operation. Covers fitted at the place of installation are also regarded as a means of protection.

1.2 Exceptions to the indications in [Table 1.12](#):

- Medium-voltage equipment, see [Section 8, Table 8.3](#)
- Electrical equipment in the reach of FWBLAFFS, see [Section 9.D.4.8](#)
- The minimum degree of protection of the terminal boxes of machines in wet operating spaces is IP 44
- In drain wells and other installation places, where temporary flooding has to be assumed, the minimum degree of protection required for all electrical equipment is IP 56.
- Spaces subject to an explosion or fire hazard shall additionally comply with the provisions of 3, as well as with [Sections 15, 16 and 17](#).

1.3 Pipe work and air ducts shall be so arranged that the electrical systems are not endangered.

1.4 If the installation of pipes and ducts close to the electrical systems are unavoidable, the pipes shall not have any flanged or screwed connections in this area.

1.5 Are flanged or screwed connections installed, if e.g. heat exchanger as integrated components of the electrical equipment are used, the flanged or screwed connections shall be protected with a shield or screen against leakage and condensed water.

1.6 The water supply lines and recirculating lines shall be fitted with shut-off valves.

1.7 Heat exchangers are preferably to install outside rooms containing major electrical equipment such as switchboards, transformer, etc.

1.8 If possible, the piping for cooler and heat exchangers shall be installed through the deck under the heat exchanger.

1.9 The flow rate and leakage of coolants of machines and static converters with closed cooling systems in electric cabinet rooms shall be monitored and alarmed. The air ducts shall be provided with inspection holes for visual observation of the heat exchanger.

1.10 A failure of cooling shall be alarmed.

1.11 It is to ensure that leakage or condensation of water does not cause an electrical failure to the liquid cooled power equipment. Leakage and condensation of water shall be monitored. The cooling medium of direct cooled systems shall be monitored regarding their insulating capacity.

1.12 Further requirements in [Section 2.F.1.3](#), [Section 6.D](#), [Section 13.1.2](#) and [Section 20.A.1.3.3](#) are to be observed.

### 2. Protection against electric shock

#### 2.1 Protection against direct contact (Basic protection)

Protection against direct contact comprises all the measures taken to protect persons against the dangers arising from contact with the live parts of electrical facilities. Live parts are conductors and conductive parts of facilities which in normal operating condition are under voltage.



**2.1.1** Electrical facilities shall be so designed that, when they are used properly, persons cannot touch, or come dangerously close to live parts. For exceptions, see [2.1.2](#) and [2.1.3](#).

**2.1.2** In locked electrical service spaces, protection against direct contact is already maintained by the mode of installation. Insulated handrails are to be fitted near live parts.

**2.1.3** In systems using safety voltage protection against direct contact may be dispensed with.

## **2.2 Protection against indirect contact (fault protection)**

Electrical facilities shall be made in such a way that persons are protected against dangerous contact voltages in the event of an insulation failure.

For this purpose, the construction of the facilities shall incorporate one of the following protective measures:

- protective earthing, see [2.3](#), or
- protection by extra-low voltage, or
- protection by electrical separation for supplying one consuming device only (voltage not exceeding 250 V), or
- protective insulation (double insulation), or
- in case where special precautions against electric shock will be necessary, the additional usage of residual current protective devices  $\leq 30$  mA (not for essential equipment).

## **2.3 Protective earthing**

Touchable conductive parts of equipment which are normally not live, but which may present a dangerous contact voltage in the event of a fault, are to be connected (earthed) to the ship's hull.

Where such earthing is not effective by fastening or mounting, protective earthing conductors are to be used.

For the earthing of cable shielding, armouring and braids, see [Section 12, D](#).

**The [Guidance for Marine Industry \(Pt.1, Vol.AC\) Sec.R-178](#) may be used as a reference.**

## **2.4 Protective earthing conductors**

The following points are to be noted with regard to the use of earthing conductors:

- An additional cable or an additional wire with a green/yellow coded core shall be provided as an earthing conductor, or the connection cable shall contain a green/yellow coded core. Cable braids and armouring shall not be used as earthing conductors.
- A conductor normally carrying current shall not be used simultaneously as an earthing conductor, nor may it be connected with the latter to the ship's hull. The green/yellow coded core shall not be used as a current-carrying conductor.
- The cross-section of the earthing conductor shall at least conform to the values indicated in [Table 1.13](#).
- Machines and devices which are insulated mounted are to be earthed by flexible cables, wires or stranded copper straps.
- The connection of the earthing conductor to the ship's hull shall be located at a point where it can easily be checked. Connections of earthing conductors shall be protected against corrosion.

- Insulated mounted structures and aluminium structures shall be connected to the ship's hull by special conductors at several points. The connections shall have a high electrical conductivity and shall be corrosion-resistant. The minimum cross-section is 50 mm<sup>2</sup> per conductor.

**Table 1.12: Minimum degrees of protection against foreign bodies and water (in conformity with publication IEC 60529)**

Equipment Location	Generators, motors, transformers <sup>1</sup>	Switchgear, electronic equipment and recording devices <sup>1</sup>	Communications equipment, display and input units, signalling equipment, switches, power sockets, junction boxes and control elements <sup>1</sup>	Heating appliances heaters and cooking equipment	Lighting fittings
Locked dry electrical service rooms	IP 00	IP 00	IP 20	IP 20	IP 20
Dry spaces, service rooms, dry control rooms, accommodation	IP 20	IP 20	IP 20	IP 20	IP 20
Wheelhouse, radio room, control stations	IP 22	IP 22	IP 22	IP 22	IP 22
Wet spaces (e.g. machinery spaces, bow thruster room, passage ways), ventilation ducts (internal), pantries, provision rooms, store rooms	IP 22 <sup>3</sup>	IP 22 <sup>3</sup>	IP 44 <sup>2</sup>	IP 22 <sup>3</sup>	IP 22 <sup>3</sup>
Machinery spaces below floor (bilge), separator and pump rooms, refrigerated rooms, galleys, laundries, bathrooms and shower rooms	IP 44	IP 44	IP 55 <sup>2, 4</sup>	IP 44 <sup>5</sup>	IP 34 <sup>5</sup>
Pipe tunnels, ventilation ducts (to open deck), cargo holds	IP 55	IP 55	IP 55 <sup>2</sup>	IP 55 <sup>5</sup>	IP 55 <sup>5</sup>
Open decks	IP 56	IP 56	IP 56	IP 56	IP 56

**Table 1.13: Cross-sections for earthing conductors**

Cross-section of outer conductor [mm <sup>2</sup> ]	Minimum cross-section of earthing conductor		
	in insulated cables [mm <sup>2</sup> ]	separately laid [mm <sup>2</sup> ]	flexible cables and wires [mm <sup>2</sup> ]
0,5 to 4	equal to cross-section of outer conductor	equal to cross-section of outer conductor but not less than 1,5 for stranded and 4 for solid earth conductor	equal to cross-section of outer conductor
>4 to 16	equal to cross-section of outer conductor	equal to half the cross-section of outer conductor but not less than 4	equal to cross-section of outer conductor but not less than 16
>16 to 35	16		
>35 to <120	equal to half the cross-section of outer conductor		
≥ 120	70	70	

### 3. Explosion protection

#### 3.1 Hazardous areas

##### 3.1.1 General

Hazardous areas are areas in which an explosive atmosphere in dangerous quantity (a dangerous explosive atmosphere) is liable to occur owing to local and operating conditions.

Hazardous areas are divided into zones depending on the probability that a dangerous explosive atmosphere may occur.

##### 3.1.2 Subdivision into zones

Zone 0 comprises areas in which a dangerous explosive atmosphere is present either permanently or for long periods. Zone 1 comprises areas in which a dangerous explosive atmosphere is liable to occur occasionally. Zone 2 comprises areas in which a dangerous explosive atmosphere is liable to occur only rarely, and then only for a brief period (extended hazardous areas).

#### 3.2 Hazardous areas, Zone 0

**3.2.1** These areas include for instance the insides of tanks and piping with a combustible liquid having a flash point ≤ 60 °C, or flammable gases, see also 3.9.

**3.2.2** For electrical installations in these areas the permitted equipment that may be fitted is:

- intrinsically safe circuits Ex ia
- equipment specially approved for use in zone 0 by a test organization recognised by BKI

**3.2.3** Cables for above mentioned equipment may be installed and shall be armoured or screened or run inside metal tubes.

#### 3.3 Hazardous areas, Zone 1

**3.3.1** These areas include areas like:

- paint rooms, kerosene lamp rooms, see also 3.5
- acetylene and oxygen bottle rooms, see also 3.6
- battery rooms, see also 3.7 and Section 2.C.2.

- areas with machinery, tanks or piping for fuels having a flash point  $\leq 60$  °C, or flammable gases, see also [3.8](#)
- ventilation ducts belonging to above mentioned areas
- insides of tanks, heaters, pipelines etc. for liquids or fuels having a flash point  $>60$  °C, if these liquids are heated to a temperature higher than 10 °C below their flash point; see also [Rules for Machinery Installations \(Pt. 1, Vol. III\) Sec.10, B.5.](#)
- see also [3.9](#) to [3.13](#)

**3.3.2** The following electrical equipment or certified safe type equipment may be installed:

- equipment, permitted for zone 0, see [3.2.2](#)
- intrinsically safe circuits Ex i
- flameproof enclosure Ex d
- pressurized Ex p
- increased safety Ex e
- special type of protection Ex s
- oil immersion Ex o
- encapsulation Ex m
- sand filled Ex q
- hermetically enclosed echo-sounders

**3.3.3** Cables for above mentioned equipment may be installed and shall be armoured or screened or run inside metal tubes, and cables for echo-sounders and cathodic protection systems, installed in thickwalled steel pipes with gastight joints up to above the main deck.

## **3.4 Extended hazardous areas, Zone 2**

**3.4.1** These areas include:

- areas directly adjoining Zone 1, but not gastight separated to it
- areas inside an airlock
- areas on open deck 1 metre surrounding openings for natural ventilation or 3 metres surrounding openings for forced ventilation for rooms, see [3.5](#), [3.6](#), [3.7](#), [3.8](#)
- see also [3.9](#) to [3.13](#)
- enclosed areas with access to zone 1 areas may be considered as safe, if the access door is gas-tight and fitted with self-closing devices without holding back arrangements (watertight door may be considered as adequately gastight) and the area is ventilated from a safe area by an independent natural ventilation system (have over-pressure ventilation with at least 6 changes of air per hour); or the adjacent area is naturally ventilated and protected by airlocks

**3.4.2** The following electrical equipment may be installed:

- equipment permitted for zone 0, see [3.2.2](#),
- equipment permitted for zone 1, see [3.3.2](#),
- equipment of Ex n-type protection,
- facilities which in operation do not cause any sparks and whose surfaces, accessible to the open air, do not attain any unacceptable temperatures,
- equipment with a degree of protection of IP 55 at least and whose surfaces, accessible to the open air, do not attain any unacceptable temperatures.

### 3.5 Electrical equipment in paint and kerosene lamp rooms

**3.5.1** In the above-mentioned rooms (classified as Zone 1 according to IEC 60092-502:1999) and in ventilation ducts supplying and exhausting these areas, electrical equipment shall be of certified safe type and comply at least with II B, T3.

Switches, protective devices and motor switchgear for electrical equipment in these areas shall be of allpoles switchable type and shall preferably be fitted in the safe area.

**3.5.2** On the open deck within a radius of 1 metre around natural ventilation openings (in and outlets) or within a radius of 3 metres around forced ventilation outlets, classified as Zone 2 according to IEC 60092-502:1999, the requirements of 3.4 shall be fulfilled. Care shall be taken to avoid exceeding temperature class T3 or 200 °C.

**3.5.3** Enclosed areas with access to paint and kerosene lamp rooms may be counted as safe areas under the following conditions; if

- the access door to the room is gastight and fitted with self-closing devices and without holding back arrangements. A watertight door may be considered as being gastight; and
- the paint and kerosene lamp rooms are ventilated from a safe area by an independent natural ventilation system; and
- warning labels are fixed to the outside of the access door, drawing attention to the combustible liquids in this room.

### 3.6 Electrical equipment in acetylene and oxygen bottle rooms

Electrical equipment in acetylene and oxygen bottle room shall be of certified safe type with explosion protection of IIC T2 at least.

### 3.7 Electrical equipment in battery rooms

Electrical equipment in battery rooms shall be of certified safe type with explosion protection of IIC T1 at least.

Arrangements and further requirements, see [Section 2.C](#).

### 3.8 Electrical equipment in fuel stores, flash point $\leq 60$ °C

Electrical equipment in fuel stores shall be of certified safe type with explosion protection of IIA T3 at least.

### 3.9 Explosion protection on tankers

Regarding hazardous areas and approved electrical equipment on tankers see:

- IEC 60092-502
- [Section 15](#)
- [Rules for Ships Carrying Liquefied Gasses in Bulk \(Pt.1, Vol. IX\)](#), see also IGC-Code of IMO
- [Rules for Ships Carrying Dangerous Chemicals in Bulk \(Pt.1, Vol. X\)](#), see also IBC-Code of IMO

### 3.10 Explosion protection for ships for the carriage of motor vehicles

Regarding hazardous areas and approved electrical equipment on ships for the carriage of motor vehicles, see [Section 16](#).

### 3.11 Explosion protection for ships for the carriage of dangerous goods

Regarding hazardous areas and approved electrical equipment on ships for the carriage of dangerous goods, see [Section 17](#).

### 3.12 Explosion protection in areas, dangerous owing to ignitable dust

**3.12.1** These areas include rooms and spaces e.g.:

- cargo holds, see also [Section 17.D.4.1](#) and [D.4.2](#)

**3.12.2** The following electrical equipment may be installed:

- equipment of certified safe type for dust explosion protection
- equipment with a degree of protection of IP 55 at least and whose surfaces do not attain any unacceptable temperatures

In continuous service, the surface temperature of horizontal surfaces and surfaces inclined up to 60° to the horizontal shall be at least 75 K below the glow temperature of a 5 mm thick layer of the dust.

### 3.13 Explosion protection in pipe tunnels

All equipment and devices in pipe tunnels containing fuel lines or adjoining fuel tanks shall be permanently installed irrespective of the flash point of the fuels. Where pipe tunnels directly adjoin tanks containing combustible liquids with a flash point below 60 °C, e.g. in ore or oil carriers, or where pipes inside these tunnels convey combustible liquids with a flash point below 60 °C, all the equipment and devices in pipe tunnels shall be certified explosion-protected in accordance with [3.3.2](#) (zone 1).

### 3.14 Permitted electrical equipment

**3.14.1** Electrical equipment shall not be installed in hazardous areas Zones 0, 1 and 2, unless it is necessary for ships operation or safety. All electrical equipment, necessary to install in hazardous areas zone 0 and 1 shall be either manufactured according to a recognised standard such as IEC 60079 and certified by an authority recognised by BKI or of a simple type belonging to an intrinsically safe circuit. Certificates for electrical equipment installed in zone 2 may be requested by BKI. Special conditions mentioned in the Certificates or in their instruction manuals have to be observed.

**3.14.2** Where electrical equipment is liable to suffer damage due to characteristics of the cargo, measures shall be taken to protect such equipment.

### 3.15 Portable electrical equipment

Portable electrical equipment, important for aboard operation and used in hazardous areas or stipulated for such use by regulations shall be of a certified safe type.

### 3.16 Earthing/ Equipotential bonding/ Static electricity

**3.16.1** All electrical equipment in hazardous areas shall be earthed regardless of the operating voltage.

**3.16.2** The hazard of an incentive discharge due to the build-up of static electricity resulting from the flow of liquids/gases/vapours can be avoided if the resistance between the cargo tanks/process plant/piping systems and the hull of the ship is not greater than  $10^6$  Ohm.

**3.16.3** This value of resistance will be readily achieved without the use of bonding straps where cargo tanks/process plant/piping systems are directly or via their supports, either welded or bolted to the hull of the ship.

**3.16.4** Bonding straps are required for cargo tanks and process plant, piping systems which are not permanently connected to the hull of the ship as the followings.

- independent cargo tanks
- cargo tanks and piping systems which are electrically separated from the hull of the ship
- pipe connections arranged for the removal of spool pieces
- wafer-style valve with non-conductive (e.g. PTFE) gaskets or seals

**3.16.5** Where bonding straps are required, they are to comply with the followings.

- to be clearly visible so that any shortcomings can be clearly detected.
- to be designed and sited so that they are protected against mechanical damage and, as far as possible, they are not affected by high resistivity contamination (corrosive product or paint).
- easy to install and replace.

### **3.17 Aerials / Electromagnetic radiation**

**3.17.1** Aerials and their riggings shall be placed outside hazardous areas.

**3.17.2** If aerials shall be placed in hazardous areas owing important reasons of ship construction or radio technology, the level of radiated power or field strength shall be limited to safe values acceptable to the appropriate authority.

## **4. Electromagnetic Compatibility (EMC)**

**4.1** Electrical and electronic equipment shall not be impaired in their function by electromagnetic energy. General measures are to extend with equal importance over:

- decoupling of the transmission path between source of interference and equipment prone to interference
- reduction of the causes of interference sources
- reduction of the susceptibility to interference

**4.2** The IEC publications 60533 and 60945 for the bridge and deck zone are to be observed.

**4.3** The requirements for electrical and electronic equipment subject to mandatory type approval regarding immunity and emissions of electromagnetic influence can be taken from the [Guidance for Approval and Type Approval of Materials and Equipment for Marine Use \(Pt.1, Vol.W\) Sec.3.V](#).

**4.4** Electrical and electronic equipment on board ships, required neither by BKI rules nor by International Conventions, liable to cause electromagnetic disturbance shall be of a type which fulfils the test requirements of the [Guidance for Approval and Type Approval of Materials and Equipment for Marine Use \(Pt.1, Vol.W\) Sec.3.V Table 3.34 no. 20 and 21](#).

## **5. Lightning protection**

Reference is made to IEC publication 60092-401.

**The [Guidance for Marine Industry \(Pt.1, Vol.AC\) Sec.R-178](#) may also be used as a reference.**

*This page intentionally left blank*



## Section 2 Installation of Electrical Equipment

A.	Availability of Main Power Supply . . . . .	2-1
B.	Generators . . . . .	2-1
C.	Storage Batteries . . . . .	2-2
D.	Power Transformers . . . . .	2-7
E.	Electronics . . . . .	2-8
F.	Low -Voltage Switchboards (up to 1000 V AC resp. 1500 V DC) . . . . .	2-8
G.	Medium Voltage Equipment (> 1 kV - 17,5 kV AC) . . . . .	2-9

### A. Availability of Main Power Supply

#### 1. Main generators

The main generators shall be installed in the main engine room or in a particular auxiliary machinery room, e.g. within the space bounded by the watertight main-bulkheads.

Partition bulkheads between these main bulkheads are not considered as separations provided they have access openings.

#### 2. Main switchboards

Under normal conditions main switchboards shall be so placed relative to the main generators that, as far as practicable, the normal supply with electrical power may be affected only by a fire or other incidents arise in the same space. The installation of the switchboard in a control room in the same fire section or in a room separated by a partition bulkhead with sufficient access opening is not to be considered as separating the switchboard from the generators.

The main switchboard shall be located as close as practicable to the main generators, within the same machinery space and the same vertical and horizontal A-60 fire boundaries.

#### 3. Distribution switchboards

Distribution switchboards supplying essential equipment and associated transformers, converters and similar equipment may be installed, if:

- the conditions as required for main generators/main switchboards are fulfilled,
- they are installed in the same fire section respectively in the same watertight compartment like the essential equipment itself.

### B. Generators

#### 1. Main generators with their own prime movers, independent of main propulsion plants

1.1 Installation of main generator see [A.1](#).

1.2 Main generators may be installed in the fore ship only with special approval and subject to the following conditions:

- Generators shall not be installed forward of the collision bulkhead below the bulkhead deck.
- The installation shall ensure faultless operation, even in heavy weather, particularly with regard to the supply of fresh air and the removal of exhaust air.
- The aggregates shall be capable of being started, connected, disconnected and monitored from the main switchboard.

## 2. Generators driven by the main propulsion plant

2.1 Where generators are to be incorporated in the propeller shafting, the generators and their foundations are to be suitably designed to ensure satisfactory operation of the propulsion plants even in heavy seas, regardless of the loading condition of the ship.

2.2 In view of the special operating conditions, the generator air gap shall, if possible, not be less than 6 mm. In the event of damage to the generator, separation of the rotor from the stator shall be possible with the means available on board, e.g. by shifting the stator.

## 3. Emergency generators

3.1 Emergency generators and their prime movers shall be installed above the uppermost continuous deck and behind of the collision bulkhead. Exceptions require BKI approval. The location in which the emergency generator is installed shall be accessible from the open deck; it shall be so located that a fire or another incident

- in a room containing the main generators and/or the main switchboard, or in
- a Category A machinery space

will not impair the operating ability of the emergency source of electrical power. See also [F.2](#).

3.2 As far as is practicable, the room containing the emergency source of electrical power, the associated transformers, converters, the transitional emergency source of electrical power and the emergency switchboard shall not adjoin the boundaries of Category A machinery spaces or of those spaces which contain the main source of electrical power, the associated transformers, converters or the main switchboard.

## C. Storage Batteries

1. Storage batteries shall be installed in such a way that persons cannot be endangered, and equipment cannot be damaged by exhausted gases or leaked-out electrolytes.

1.1 Storage batteries for essential equipment and associated power supply unit / charger and distribution switchboards are to be installed according [A.3](#). For example, the automation battery in the engine room. For storage batteries supplying emergency consumers, [4](#). and [F.2.2](#) are to be observed.

1.2 Storage batteries shall be so installed as to ensure accessibility for changing of cells, inspection, testing, topping-up and cleaning. Storage batteries shall not be installed in the accommodation area or in cargo holds. An exception may be granted for gastight cells, such as those used in emergency lamps, where charging does not result in the development of harmful gases.

1.3 Storage batteries shall not be installed in positions where they are exposed to excessively high or low temperatures, water spray, moist, dust, condensation or other factors liable to impair their serviceability or shorten their service life. The minimum degree of protection required is IP 12.

**1.4** When installing storage batteries, attention is to be paid to the capacity of the associated chargers. The charging power is to be calculated as the product of the maximum charger current and the rated voltage of the storage battery.

Depending on the operating mode, application and duty of the storage battery to be charged, and on the mode of the charging (charger characteristic), and by agreement with BKI, the calculation of the charging capacity need not be based on the maximum current. For the typical automatic IU- charging the calculation is stated under [4.3](#).

**1.5** Storage batteries are to be provided with overload and short-circuit protection nearby where they are installed. Exceptions are made for batteries for preheating and starting of internal combustion engines, but their cabling shall be made short-circuit proof.

**1.6** Applied materials shall comply with [Section 1.J](#).

**1.7** Storage batteries shall be prevented from sliding. The constraints shall not hinder ventilation.

**1.8** Storage batteries are subject to recycling.

**1.9** On tankers, storage batteries shall not be installed in the cargo area.

## **2. Battery systems**

A battery system is an interconnection of storage batteries wired in series, parallel or as a combination of both connections. These systems are installed in cabinets or battery rooms.

**2.1** Only storage batteries of same electrochemical characteristics, type, brand and year of construction shall be connected to a battery system. The selected configuration of a battery system shall not be changed.

**2.2** The maximum permitted voltage of a battery system is 1500 V DC.

**2.3** Only authorized personnel shall have access to locked cabinets or battery rooms. Safety measures are to be taken against electric shock.

**2.4** Storage batteries shall withstand internal and external short-circuits. The level of expected shortcircuit current shall be considered for the DC network design and its switching and protection devices.

**2.5** Disconnecting devices shall be provided to isolate conductors of battery systems from circuits and if applicable from protected earth.

**2.6** Battery systems for redundant installations shall not be installed in the same cabinet or battery room. The requirements of redundancy shall be applied to the auxiliary systems and cooling systems as well.

**2.7** Battery systems for emergency supply shall not be installed in the same cabinet or battery room as storage batteries for other consumers.

**2.8** Battery systems shall be labelled. Access hatches or other openings to cabinets or battery rooms shall give instructions to personnel safety.

### **2.9 Cooling system**

**2.9.1** No additional heat sources shall be installed in spaces of storage batteries. Cabinets or battery rooms shall be equipped with controlled heating systems if applicable.

**2.9.2** Redundant cooling or ventilation systems shall be provided including monitoring and alarm in case of abnormal operation.

**2.9.3** Preferably air or liquid flow monitoring devices shall be provided. Differential pressure indicators are not recommended.

### **2.10 Protection**

**2.10.1** A ground fault detection system shall be provided for the DC network.

**2.10.2** Management, monitoring and protection systems shall be provided. These systems are subject to BKI type approval and shall include the following functions at least:

- control and monitoring during charging, discharging and operation
- protection against overcharging, discharging and against deep discharge

**2.10.3** An independent temperature monitoring system shall be provided. This monitoring shall give an alarm if temperature difference between the inner of cabinets or battery rooms and the environmental is too large.

**2.10.4** A documentation shall be submitted to verify safe operation of the battery system and relating to the personal protection.

### **2.11 Installation and maintenance**

**2.11.1** The manufacturer instructions regarding installation, maintenance, operation and cooling of the battery system are to be observed.

**2.11.2** Positive (+) and negative (-) wiring shall have equal wire length

**2.11.3** It is recommended to check periodically cable connections and to use e.g. an infrared (IR) camera to detect hot spots in the battery system if any.

### **3. Equipment in cabinets and battery rooms**

**3.1** During charging, discharging or internal failures storage batteries could generate and release explosive gases.

**3.2** Only explosion-protected lamps, switches, fan motors and space-heating appliances shall be installed in battery rooms. The following minimum requirements shall be observed:

- Explosion group II C
- Temperature class T 1

Other electrical equipment is permitted only with the special approval of BKI.

**3.3** Where leakage is possible, the inner walls of battery-rooms, boxes and cupboards, and all supports, troughs, containers and racks, shall be protected against the injurious effects of the electrolyte.

**3.4** Electrical equipment shall be installed in cabinets or battery rooms only when it is unavoidable for operational reasons.

### **4. Ventilation of spaces containing batteries**

#### **4.1 General requirements**

All battery installations, except for gastight batteries, in rooms, cabinets and containers shall be constructed and ventilated in such a way as to prevent the accumulation of ignitable gas mixtures.

Gastight Ni Cd-, Ni MH- or Li-batteries need not be ventilated.

#### **4.2 Batteries installed in switchboards with charging power up to 0.2 kW**

Lead batteries with a charging power up to 0.2 kW may be installed in switchboards without separation to switchgear and without any additional ventilation, if:

- 1) the batteries are valve regulated (VRLA), provided with solid electrolyte
- 2) the battery cases are not closed completely (IP 2X is suitable)
- 3) the charger is regulated automatically by an IU-controller with a maximum continuous charging voltage of 2,3 V/cell and rated power of the charger is limited to 0,2 kW

### 4.3 Ventilated spaces with battery charging power up to 2 kW

Batteries may be installed in ventilated cabinets and containers arranged in ventilated spaces (except rooms mentioned in 1.1)

The unenclosed installation (IP 12) in well ventilated positions in machinery spaces is permitted.

Otherwise, batteries shall be installed in ventilated battery cabinets or containers.

The charging power for automatic IU-charging shall be calculated as follows:

$$P = U \cdot I$$

P = Charging power [W]

U = Rated battery voltage [V]

I = Charging current [A]

=  $8 \cdot K/100$  for Pb batteries

=  $16 \cdot K/100$  for NiCd batteries

K = Battery capacity [Ah]

The gassing voltage shall not be exceeded. If several battery sets would be used, the sum of charging power has to be calculated.

The free air volume in the room shall be calculated depending on battery size as follows:

$$V = 2,5 \cdot Q$$

$$Q = f \cdot 0,25 \cdot I \cdot n$$

V = Free air volume in the room [m<sup>3</sup>]

Q = Air quantity [m<sup>3</sup>/h]

n = Number of battery-cells in series connection

f = 0,03 for lead batteries with solid electrolyte

f = 0,11 for batteries with fluid electrolyte

If several battery sets would be installed in one room, the sum of air quantity shall be calculated.

Where the room volume or the ventilation is not sufficient, enclosed battery cabinets or containers with natural ventilation into suitable rooms or areas shall be used.

The air ducts for natural ventilation shall have a cross-section as follows, assuming an air speed of 0.5 m/s:

$$A = 5,6 \cdot Q$$

A = Cross-section [cm<sup>2</sup>]

The required minimum cross-sections of ventilation ducts are shown in [Table 2.1](#).

Small air ducts and dimensions of air inlet and outlet openings shall be calculated based on lower air speed.

### 4.4 Ventilated rooms with battery charging power more than 2 kW

Batteries exceeding charging power of 2 kW shall be installed in closed cabinets, containers or battery rooms forced ventilated to open deck area. Lead batteries up to 3 kW may be ventilated by natural means.

Battery rooms shall be arranged according to 2.

### 4.5 Ventilation requirements

Ventilation inlet and outlet openings shall be so arranged to ensure that fresh air flows over the surface of the storage battery.

The air inlet openings shall be arranged below, and air outlet openings shall be arranged above.

If batteries are installed in several floors, the free distance between them shall be at least 50 mm.

Devices which obstruct the free passage of air, e.g. fire dampers and safety screens, shall not be mounted in the ventilation inlet and outlet ducts of battery-rooms.

Air ducts for natural ventilation shall lead to the open deck directly.

Openings shall be at least 0,9 metre above the cupboard/boxes. The inclination of air ducts shall not exceed 45° from vertical

Battery room ventilators are to be fitted with a means of closing whenever:

- The battery room does not open directly onto an exposed deck, or
- The ventilation opening for the battery room is required to be fitted with a closing device according to the Load Line Convention (i.e. the height of the opening does not extend to more than 4,5 metres (14,8 feet) above the deck for position 1 or to more than 2,3 metres (7.5 feet) above the deck in position 2), or
- The battery room is fitted with a fixed gas fire extinguishing system.

Where a battery room ventilator is fitted with a closing device, then a warning notice starting, for example "This closing device is to be kept open and only closed in the event of fire or other emergency EXPLOSIVE GAS", is to be provided at the closing device to mitigate the possibility of inadvertent closing.

#### 4.6 Forced ventilation

If natural ventilation is not sufficient or required cross-sections of ducts according to Table 2.1 are too big, forced ventilation shall be provided.

The air quantity Q shall be calculated according to 3.3.

The air speed shall not exceed 4 m/s.

Where storage batteries are charged automatically, with automatic start of the fan at the beginning of the charging, arrangements shall be made for the ventilation to continue for at least 1 hour after completion of charging.

Wherever possible, forced ventilation exhaust fans shall be used.

The fan motors shall be either certified safe type with a degree of protection IIC T1 and resistant to electrolyte or, preferably, located outside of the endangered area.

Fans are to be of non-sparking construction.

The ventilation systems shall be independent of the ventilation systems serving other rooms. Air ducts for forced ventilation shall be resistant to electrolyte and shall lead to the open deck

**Table 2.1: Cross-section of ventilation ducts**

Calculation based on battery charging power (automatic IU-charging)			
Battery charging power [W]	Cross-section[cm <sup>2</sup> ]		
	Lead battery solid electrolyte VRLA	Lead battery fluid electrolyte	Nickel-Cadmium battery
<500	40	60	80
500 <1000	60	80	120
1000 <1500	80	120	180
1500 <2000	80	160	240
2000 <3000	80	240	forced-ventilation
>3000	forced ventilation		

## 5. Emergency power supply

The location in which storage batteries for the emergency power supply are installed shall fulfil the same conditions as required for the installation of the emergency generator, see B.3.

## 6. Batteries for starting of internal combustion engines

6.1 Batteries for starting of internal combustion engines shall be installed near the engine.

6.2 For the rating of the batteries, see [Rules for Machinery Installations \(Pt.1, Vol.III\) Sec.2.H.3](#).

## 7. Caution labels

The doors or the covers of battery rooms, cupboards or boxes shall be fitted with caution labels prohibiting the exposure of open flames and smoking in, or close to, these spaces.

## 8. Recording of the type, location and maintenance cycle of batteries

8.1 Where batteries are fitted for use for essential and emergency services a schedule of such batteries is to be compiled and maintained. The schedule, which is to be approved by BKI during plan approval or the new building survey, is to include at least the following information regarding the battery (ies):

- type and manufacturer's type designation
- voltage and ampere-hour rating
- location
- equipment and/or system(s) served
- maintenance / replacement cycle dates
- date(s) of last maintenance and/or replacement
- for replacement batteries in storage, the date of manufacture and shelf life<sup>1)</sup>

8.2 Procedures are to be put in place to ensure that where batteries are replaced that they are of an equivalent performance type.

8.3 Where vented<sup>2)</sup> type batteries replace valve-regulated sealed<sup>3)</sup> types, it is to be ensured that there is adequate ventilation and that the BKI requirements relevant to the location and installation of vented types batteries are complied with.

8.4 Details of the schedule and of the procedures are to be included in the ship's safety management system and be integrated into the ship's operational maintenance routine as appropriate<sup>4)</sup> to be verified by BKI surveyor.

## D. Power Transformers

1. Transformers shall be installed at readily accessible and adequately ventilated places

2. The location of transformers for main electrical power supply shall fulfil the same conditions as those applying to the installation of the main generators, see B.1.

3. The location in which transformers for the emergency electrical power supply are installed shall satisfy the same conditions as apply to the installation of the emergency generator, see B.3.

<sup>1)</sup>Shelf life is the duration of storage under specified conditions at the end of which a battery retains the ability to give a specified performance.

<sup>2)</sup>A vented battery is one in which the cells have a cover provided with an opening through which products of electrolysis and evaporation are allowed to escape freely from the cells to atmosphere.

<sup>3)</sup>A valve-regulated battery is one in which cells are closed but have an arrangement (valve) which allows the escape of gas if the internal pressure exceeds a predetermined value

<sup>4)</sup>See section 10 of the IMO ISM Code

4. For medium-voltage transformers, see [G](#).
5. If multiple transformers are required, each transformer is to be located as a separate unit with separate enclosure of equivalent and is to be served by separate circuits on the primary and secondary sides. Each primary circuit is to be provided with switch-gear and protection devices in each phase.
6. Transformers supplying bow thruster are excluded from the requirements in [5](#), [Section 3.B.1.12](#), and [Section 4.D.4](#).

## E. Electronics

1. Power electronic equipment and central units for information processing shall be installed in readily accessible and adequately ventilated spaces.
2. The heat generated in the unit shall be removed in a suitable manner. Where electronic equipment is installed in engine rooms or other spaces with enhanced danger of pollution and corrosion, air filters shall be provided if necessary.

## F. Low -Voltage Switchboards (up to 1000 V AC resp. 1500 V DC)

### 1. Main switchboards

- 1.1 Installation of main switchboards see [A.2](#).
- 1.2 If installed on the floor above the bilge, the main switchboard shall be completely closed from below.
- 1.3 Pipe work and air ducts shall be arranged so that the switchgear is not endangered in the event of leaks. If the installation of these pipes and ducts close to the switchboard is unavoidable, the pipes should not have any flanged or screwed connections in this area. See also [Section 1, K](#). and [Rules for Machinery Installations \(Pt.1, Vol.III\) Sec.11.D.3. and G.3](#).
- 1.4 The heat generated in the switchgear shall be removed.
- 1.5 The control passageway in front of the main switchboard shall be at least 0,9 metre wide. An ample view shall be provided for the operation of the board.

Where free-standing panels are required to be accessible from behind for operation and maintenance, a passageway at least 0,6 metre wide shall be provided. The width may be reduced to 0,5 metre in the positions of reinforcements and frames.

- 1.6 The floor in front of, and where necessary behind, main switchboards with an operating voltage of more than 50 V shall be provided with an appropriately insulating covering or insulating gratings or mats (e.g. according IEC 61111 as amended) shall be in place.
- 1.7 The operational space behind open switch-boards shall be erected as a separated electrical service room. A label notifying this fact shall be fitted.

### 2. Emergency switchboards

- 2.1 The emergency switchboard shall be installed close to the emergency generator and/or the emergency battery. The requirements of [C](#). shall be observed. The place of installation shall satisfy the same conditions as apply to the installation of the emergency generator. The installation of the emergency switchboard is subject to the same conditions as those stated in [1.3](#), [1.4](#), [1.6](#) and [1.7](#) for the main switchboard.
- 2.2 Where the emergency source of electrical power is an accumulator battery it shall not be installed in the same space as the emergency switchboard

### 3. Main distribution boards

The requirements set out in [Section 14](#), [1.4](#) and [1.7](#) for main switchboards also apply to main distribution panels. Installation see [A.3](#).



#### 4. Sub-distribution boards

4.1 Cubicles and niches housing distribution panels shall be made of incombustible material or be protected by a lining of metal or some other fireproof material.

The doors of cubicles and niches shall be provided with a name plate identifying the distribution panel inside. Adequate ventilation shall be ensured.

4.2 Regarding additional requirements for passenger vessels, see [Section 14](#).

4.3 Distribution boards may be located behind panels/linings within accommodation spaces including stairway enclosures, without the need to categorize the space, provided no provision is made for storage.

If distribution boards are located in an identifiable space having a deck area of less than 4 m<sup>2</sup>, this space may be categorized in [7], according to [Table 22.1](#) and [Table 22.2](#) of [Rules for Hull \(Pt.1, Vol.II\) Sec.22, B](#), or [5], according to regulations [Table 22.3](#) and [Table 22.4](#) of [Rules for Hull \(Pt.1, Vol.II\) Sec.22, C](#), [Table 22.5](#) and [Table 22.6](#) of [Rules for Hull \(Pt.1, Vol.II\) Sec.22, E](#) and [Table 22.7](#) and [Table 22.8](#) of [Rules for Hull \(Pt.1, Vol.II\) Sec.22, F](#).

### G. Medium Voltage Equipment (> 1 kV - 17,5 kV AC)

#### 1. General

1.1 The degrees of protection stated in [Section 8](#). [Table 8.3](#) are to be adhered.

1.2 Equipment should preferably be installed in enclosed electrical service rooms.

1.2.1 Electrical equipment which only ensures the lowest required protection against contact according to [Table 8.3](#) shall be installed in a locked electrical operational compartment.

1.2.2 If the lowest required protection against contact according to [Table 8.3](#) is not ensured, the equipment shall be installed in rooms whose access doors shall be locked in such a way that they can only be opened after isolating and earthing of the supply circuits.

1.3 If during operation the protection against accidental arcing at the place of installation or in their vicinity not insured, the hazarded areas are to be blocked off by appropriate means and to be marked with warning labels. The continuous stay of personal in the hazarded areas shall be avoided. Therefore, control panels, device for vocal communication etc. may not be installed in this area. In addition, the clearance between the switchboard and the ceiling/deckhead above is to meet the requirements of the Internal Arc Classification according to IEC 62271-200.

1.4 The place of installation of switchgear without valid arc test shall be interlocked that access should be given only when the equipment is isolated. Other components, for which an arc test is required, shall be considered accordingly.

#### 2. Access doors to service rooms

The access doors to spaces in which medium-voltage equipment is installed shall be provided with caution labels in accordance with [6](#).

#### 3. Switchgear

##### 3.1 Pressure release

3.1.1 If the gas pressure resulting from accidental arcs within the switchboard is to be vented via pressure-release flaps, the installation space shall be as specified by the switchgear manufacturer and shall have an adequate volume. Suitable measures shall be taken to ensure that the overpressure occurring within the space is limited to physiologically acceptable limits. The overpressure shall be taken into account for the structural design of the room. It is recommended to lead the accidental-arc gases by ducts of sufficient cross-section out of the place of operation.

Accidental arc gases shall be vented in a way, that the hazard of persons and equipment is minimized.

**3.1.2** If the switchboard is designed so that the gas pressure caused by accidental arcs is also, or only, released downwards, the floor shall be constructed so that it can withstand this pressure. Care shall be taken to ensure that sufficient volumes of space are available below the floor for the expansion of the accidental-arc gases. Combustible materials and low-voltage cables are not admissible in the endangered area.

**Note**

*Compartments, subjected to arc gases, shall be equipped with sufficient exhaust ventilation, where necessary supplied from the emergency switchboard.*

**3.2 SF<sub>6</sub> switchgear**

**3.2.1** SF<sub>6</sub> switchgear shall only be installed in spaces which are adequately ventilated. An exhaust fan shall be provided. It shall be ensured that SF<sub>6</sub> is prevented from flowing down to lower spaces.

**Note**

*It shall be taken into consideration that the coming out gases in case of accidental arcing have toxic and corrosive effects.*

**3.2.2** The SF<sub>6</sub> cylinders shall be stored in a separate space with its own venting arrangements. Measures shall be taken to ensure that, in the event of leakage, no gas can flow unnoticed into any lower spaces.

**3.3 Standing surface insulation**

**3.3.1** In front of switchboards a standing surface insulation shall be provided

**3.3.2** The insulation shall be done by a suitable insulating matting (e.g. according IEC 61111 as amended).

**3.3.3** It shall be impossible to touch the front of the switchboard from outside of this insulating matting.

**3.4 Auxiliaries for main switchboards**

Auxiliaries necessary for the operation of the main switchboard have to be installed so that their function is only affected by fire or other incidents within the same compartment.

**4. Liquid cooled transformers**

**4.1** Liquid cooled transformers shall be provided with a collecting arrangement which permits the proper disposal of the liquid.

**4.2** A fire detector and a suitable fire extinguishing system shall be installed in the vicinity of the transformer.

**5. Ship service transformers**

Ship service transformers with a degree of protection lower than the minimum required degree of protection according to [Section 8. Table 8.3](#) shall be installed in separate compartments.

**6. Safety equipment**

At least the following safety equipment has to be provided for medium-voltage facilities:

- a voltage detector suitable for the rated voltage of the equipment
- a sufficient number of earthing cables according to IEC 61230 as amended, including insulated fitting tools
- an insulating matting (mat for repair / maintenance)

- a sufficient number of warning labels "Do not switch"
- safety instructions for gas insulated switchboards

### **7. Marking**

All parts of medium-voltage installations are to be fitted with permanent warning labels drawing attention to the voltage level and the danger.

*This page intentionally left blank*

## Section 3 Power Supply Installations

A.	Electrical Power Demand . . . . .	3-1
B.	Main Electrical Power Supply . . . . .	3-1
C.	Emergency Electrical Power Supply . . . . .	3-7
D.	Operation of the Emergency Generator in Port . . . . .	3-10

### A. Electrical Power Demand

1. A power balance of the electrical equipment has to be submitted to proof the sufficient ratings of units for the generating, storage and transformation of electrical energy.

1.1 The power demand has to be determined for the following operating conditions:

- navigation at sea
- estuary trading and navigation close to port
- emergency power supply

1.2 Extreme environmental conditions, e.g. arctic or tropical conditions, appropriate to the ship's area of operation are also to be taken into account.

1.3 In compiling the power balance, all installed electrical consumers are to be tabulated together with an indication of their power inputs.

2. For the various operating conditions, attention is to be given to:

2.1 The full power input of all consumers continuously required for operation, except for those consumers which remain on standby and are used only when a similar consumer fails.

2.2 The power input of all temporarily used consumers multiplied by a diversity factor.

The consumers mentioned in 2.3 are excluded.

The diversity factor shall be applied only once during the calculation.

2.3 The full power input of consumers with a high-power consumption relative to the main power supply, e.g. lateral thrusters (see also B.1.4).

2.4 Short-term peak loads caused, for example, by the automatic starting of large motors. Proof is required of reserve power.

### B. Main Electrical Power Supply

#### 1. Design

1.1 Every ship is to be provided with a main source of electrical power with sufficient capacity to meet the requirements of the plant mentioned in Section 1.A.2. This main source of electrical power shall consist of at least two mutually independent generating sets.

**1.2** The capacity of the generating sets mentioned in [1.1](#) shall be such that, if any one generating set should fail or be shut down, the remaining generating capacity is sufficient to supply all those items of equipment which are needed, when navigating at sea, to ensure:

- normal operational conditions of propulsion and safety of the ship
- a minimum of comfortable conditions of habitability
- preservation of the cargo, as far as the equipment provided is part of the classification

Minimum comforts for living on board include at least adequate services for lighting, cooking, heating, domestic refrigeration, mechanical ventilation, sanitary and drinking water.

**1.3** For determination of generators capacity on ships with classified refrigeration equipment (Class Notation "RIC") or with other addenda to their Character of Classification (e.g. "dredger") the power demand arising from the associated special operating conditions shall also be considered.

**1.4** For determination of generators capacity on ships with classified refrigerated containers (Class Notation "RCP x/y") the power demand according to the Guidelines for the Carriage of Refrigerated Containers on Board Ships shall be considered.

**1.5** If no operational data are available for container connections, the following values are to be assumed when calculating the power demand:

- 20' Reefer container      8,6 kW
- 40' Reefer container      12,6 kW

For unrestricted operation of refrigerated containers and to consider all kind of reefer cargoes and operation conditions (e.g. fruit cargo and cooling down) the diversity factor 0,9 is defined.

For certain cargoes and operation conditions (e.g. deep-frozen cargo, mixed cargo) lower values could be necessary and accepted.

The power demand for the cargo holds ventilation is to be considered

**1.6** Notwithstanding the provisions of [1.2](#), all main generators may be taken into account when considering the operation of equipment to assist in manoeuvring the vessel (e.g. lateral thrusters) and when cooling down refrigerated cargo (e.g. on Refrigerated Cargo Ships and Liquefied Gas Tankers).

**1.7** For ships with restricted zones of operation or intended for a special purpose, exemptions may be approved on an individual case basis.

**1.8** The arrangements of the ship's main source of electrical power shall be such that operation in accordance with [Section 1.A.2](#). can be maintained regardless of the speed and direction of rotation of the main propulsion machinery or shafting.

The use of generators driven by the main propulsion plant is subject to the requirements mentioned in item [4](#).

**1.9** The ship machinery installations shall be so designed, that they can be brought to operation from dead ship condition.

"Dead ship" condition means that the complete machinery plant including the main source of electrical power are out of operation and auxiliary energy as compressed air, starting current from batteries etc. are not available for the restoration of the main power supply, for the restart of the auxiliaries and for the startup of the propulsion plant. It is however assumed that the equipment for start-up of the emergency dieselgenerator is ready for use.

**1.10** Emergency generators may be used for the raising of the dead ship condition where the independent emergency power supply is safeguarded at any time, see also [C.1.3](#) and [1.4](#).

**1.11** It is to be ensured that in the event of failure of the main electrical power supply (black-out) this supply can be restored to operation even without the aid of the emergency electrical power source.

**1.12** If transformers, storage batteries with their charging equipment, converters and suchlike are essential components of the main electrical power supply, the availability of the entire supply system demanded in accordance with 1.2 and Section 2.A. shall remain guaranteed if any one unit breaks down.

## **2. Rating and control of alternating and three-phase current generators of the main electrical power supply**

### **2.1 Apparent power**

The apparent power of three-phase generators shall be such that no inadmissible voltage drops occur in the ship's mains due to the normal starting currents of motors. The start-up of the motor with the greatest starting current shall not give rise to a voltage drop causing other consumers to malfunction. Where a number of generators operate in parallel, this condition shall continue to be met when the largest generator is not in operation.

### **2.2 Waveform**

The waveform of the line-to-line no-load voltage shall be as close as possible to sinusoidal. The deviation from a sinusoidal fundamental shall at no time exceed 5 % relative to the peak value of the fundamental. The RMS values of the phase voltages shall not differ from each other by more than 0,5 % under balanced load conditions.

If the star points of generators running in parallel are earthed, the waveforms of the phase voltages should coincide. It is to ensure that the transient current due to harmonics in the star point connection does not exceed 20 % of the rated current of the machine with the lowest output.

### **2.3 Exciterequipment**

Generators and their exciters are to be rated in such a way that:

- the generator can be loaded for 2 minutes at 150 % of its rated current with a power factor of 0,5 lagging (inductive) and still deliver approximately its rated voltage
- the equipment is short-circuit-proof even having regard to the time lag of the generator circuit breakers necessary to the selectivity of the system

### **2.4 Regulating conditions**

Under balanced load conditions, three-phase generators and their exciters are required to meet the following conditions (emergency generators, see also C.1.6):

#### **2.4.1 Steady regulating conditions**

With the generator running at rated speed, the voltage shall not deviate from the rated value by more than  $\pm 2,5\%$  from no-load up to the rated output and at the rated power factor after the transient reactions have ceased.

#### **2.4.2 Transient regulating conditions**

With the generator running at rated speed and rated voltage, the voltage shall neither fall below 85 % nor exceed 120 % of the rated value when symmetrical loads of specified current and power factor are suddenly applied or removed. The voltage shall regain its rated value  $\pm 3\%$  in 1,5 seconds.

If no particular requirements are specified for the load changes, the above conditions are to be satisfied when the generator, running idle and excited to its rated voltage, is suddenly loaded to 60 % of its rated current with a power factor of  $< 0,4$  (lagging), and after steady-state operation has been achieved, the load is suddenly switched off again. Subject to BKI's approval, such voltage regulation during transient conditions may be calculated values based on the previous type test records and need not to be tested during factory testing of a generator.

### 2.4.3 Steady short-circuit current

With a terminal short-circuit on three phases, the steady short-circuit current shall not be less than three times or not greater than 6 times the rated current. The generator and its exciter shall be capable of withstanding the steady short-circuit current for 2 seconds without damage.

### 2.5 Load sharing during parallel operation

Where generators of the same output are operated in parallel, the reactive load of each machine shall not differ from its proportionate share by more than 10 % of its rated reactive power when the active load is shared equally.

In the case of generators running parallel with different ratings, the deviation from the proportionate share shall not exceed the lesser of the following values, assuming proportionately equal sharing of the active load:

- 10 % of the rated reactive power of the largest machine
- 25 % of the rated reactive power of the smallest machine

### 2.6 Direct current generators

Compound generators or shunt-wound generators with automatic voltage regulators are to be preferred for sets supplying ship's mains.

Technical details and limiting values are to be agreed with BKI

## 3. Design and equipment of generator prime movers

### 3.1 General

The design and mechanical equipment of generator prime movers is to be undertaken in accordance with the [Rules for Machinery Installations \(Pt.1, Vol.III\) Sec.2](#) and [Sec.3.I](#) and [3.II](#).

### 3.2 Speed change equipment

Every diesel engine driving a ship's main generator shall have speed change equipment which permits adequately rapid synchronization.

On ships with shaft-driven generators the range of speeds of main generator and auxiliary diesel which can be set is to be so designed that even at the minimum operating speed acceptable for shaft-driven generator operation, correct synchronization of and entering by the auxiliary units is possible in all weather conditions.

### 3.3 Electrical starting equipment

Regarding electrical starting equipment, see [Section 7.D.6](#).

### 3.4 Speed governors

**3.4.1** Regarding requirements for mechanical speed governors, see [Rules for Machinery Installations \(Pt.1, Vol.III\) Sec.2](#).

**3.4.2** Regarding additional requirements for electronic/ electrical speed control, see [Section 9.B](#).

### 3.5 Load switching

**3.5.1** Regarding further requirements, see [Rules for Machinery Installations \(Pt.1, Vol.III\) Sec.2.F](#).



### 3.5.2 Load cutting in

If the load switching in two steps is provided, it is to be realised as follows: immediately from 'no load' to 50 %, followed by the remaining 50 % of the generator output while remaining within the permissible speed-change limits.

Load switching in more than two steps is permissible provided that:

- the design of the ship's mains makes possible the operational application of such units
- load switching in several steps has been given appropriate consideration at the design stage of the ship's mains and is approved through the drawing checks
- proof of unobjectionable functioning is provided in the course of the on-board tests. This is to include consideration of the loading of the ship's mains under stepped switching in of essential equipment following breakdown and reconstruction of the ship's mains
- furthermore, safety of the ship's mains under parallel operation of the generators is to be proved.

### 3.5.3 Load shedding

Load shedding of 100 % of the generator rated output, while adhering to the permissible speed changes, shall be proven.

## 3.6 Parallel operation

**3.6.1** The speed characteristics of prime movers shall be linear over the entire output range.

The governing characteristics of prime movers of units of the same output operating in parallel shall ensure that, over the range from 20 % to 100 % of the total active power, the share of each machine does not deviate from its proportionate share by more than 15 % of its rated active power.

**3.6.2** Where the units are differently rated, the deviation from the proportionate share within the stated load range shall not exceed the lesser of the following values:

- 15 % of the rated active power of the largest machine
- 25 % of the rated active power of the smallest machine

## 3.7 Cyclic irregularity

The permissible cyclic irregularity is to be agreed between the manufacturers of the prime movers and the generators. The following points have to be ensured:

- Faultless parallel operation of three-phase generators
- Load variations shall not give rise to fluctuations in active power output exceeding 10 % of the rated output of the machine concerned.

## 4. Generators driven by the main propulsion plant (e.g. shaft-driven generators)

**4.1** Generators driven by the main propulsion plant may be deemed to constitute part of the main electrical power supply in accordance with 1. provided they can be operated under all weather, navigating and manoeuvring conditions, including stopped ship by supplying sufficient load. The operating conditions for frequency stated in [Section 1.F](#). shall be fulfilled. Voltage and load sharing shall be in the limits acc. to [2.1](#), [2.2](#), [2.4.1](#), [2.4.2](#) and [2.5](#) in addition to requirements of IEC 60092-301: 1980/AMD2:1995 as amended (only to be observed in case of parallel operation).

**4.1.1** It is an essential requirement that, should any generator or its prime mover fail, the conditions stated in 1.2 shall be satisfied, and it shall also be possible to start the main propulsion plant in accordance with 1.9, 1.10 and C.1.4.

**4.1.2** Provision shall be made for decoupling generators not lying in the line of the propeller shaft.

**4.1.3** The generators shall be protected in such a way that a short-circuit in the main busbars will not cause a damage in the generator system and a subsequent restoration of normal generator function will be possible.

**4.2** Generators which are driven by the main propulsion plant, but which fail to conform to the conditions stated in 4.1, and consequently the requirements of IEC 60092-201: 2019 paragraph 8.1.1, are not considered to constitute part of the main electrical power supply, although they may be used as additional generators and on occasion maintain the entire power supply function provided the following conditions are met:

- Where main propulsion plants are not driven at constant speed, regulators should be fitted enabling the generator plant to deliver an adequate output over a speed range of the main engine from at least 75 % to 100 %.
- Frequencies are to be kept within the limits stated in Section 1.F. For voltage and load sharing (only in case of parallel operation) furthermore the conditions stated in 2.1, 2.4.1, 2.4.2 and 2.5, in addition to requirements of IEC 60092-301:1980/AMD2:1995 as amended are to be fulfilled.
- There are sufficient and adequately rated additional generators fitted, which constitute the main source of electrical power required by SOLAS, meeting the requirements of IEC 60092-201:2019 paragraph 8.1.1.
- Arrangements are fitted to automatically start one or more of the generators, constituting the main source of electrical power required by SOLAS, in compliance 5.2.4 and requirements below.
- Where considered appropriate, load shedding arrangements are fitted to meet the requirements of 5.2.1.
- On ships with remote control of the main engine from the bridge, it is necessary to ensure that, when manoeuvres preventing the continued operation of the shaft-driven generator plant are initiated, the supply to essential equipment is maintained from the shaft-driven generator plant until the load has been shifted to a stand-by generator.
- The short circuit current of the generator and/or generator system is sufficient to trip the generator/generator system circuit-breaker taking into account the selectivity of the protective devices for the distribution system

**4.3** For the selectivity demands of the distribution system the short-circuit current shall be sufficient.

**4.4** In case of frequency deviations exceeding 10 %, the generator is to be disconnected within 10-30 seconds.

**4.5** where considered appropriate, load shedding arrangements are fitted to meet the requirements of 5.2.1.

## **5. Availability of the main electrical source**

**5.1** Where the main source of electrical power is necessary for propulsion and steering of the ship, the system shall be so arranged that the supply of the primary essential equipment will be maintained or immediately restored in the case of loss of any one of the generators in service.

**5.2** To fulfil the demands named in 5.1, at least the following measures are required:

**5.2.1** Automatic load shedding of the non-essential and, where necessary, secondary essential equipment to protect the generators against overload.

### 5.2.2 Automatic start-up of a stand-by unit on failure of the power supply.

At least two units shall be provided according to [Section 3.B](#). They shall be capable of reciprocal operation. The output of each unit shall be so rated as to ensure automatic start-up of the primary essential equipment. Where necessary, equipment may be switched on in staggered formation.

5.2.3 Start-up and connecting of a stand-by unit from the bridge with special approval. The requirements specified in [5.2.2](#) are to be observed.

5.2.4 The automatic starting and connecting on of a generator and the primary essential equipment after black-out shall follow as quick as possible, preferably within 30 seconds, but in any case, not more than 45 seconds. Where diesel engines with longer starting times are used the starting and connecting times might be exceeded with approval of BKI.

5.2.5 Where several generator units are required to cover the ship's power supply in permanent parallel operation, the failure of already one of the units shall cause the immediate trip of non-essential equipment and, where necessary, the secondary essential equipment, where this is the only way to ensure that the remaining units can supply the primary essential equipment.

## C. Emergency Electrical Power Supply

### 1. General requirements

1.1 The emergency source of electrical power shall take over the supply of the emergency consumers in case of failure of the main source of electrical power. It shall be independent of the main source of electrical power.

1.2 The capacity of the emergency source of electrical power shall be sufficient to supply all those services which are essential for safety in an emergency.

1.3 Provided that suitable measures are taken for safeguarding independent emergency operation under all circumstances, the emergency generator may be used exceptionally and for short periods to supply non-emergency circuits, see also [B.1.10](#) and [D](#).

1.4 For ships which need electrical power to restore propulsion, the capacity of the emergency source of power shall be sufficient to restore propulsion to the ship in conjunction with other auxiliary machinery, as appropriate, within 30 minutes after black-out. It is assumed that starting energy is not available after black-out. For steam ships the 30 minutes admit until start-up of the first boiler, see also [B.1.7](#) and [1.8](#).

1.5 For all equipment forming part of the emergency source of electrical power, provision shall be made for periodic functional tests, including especially the testing of automatic switching and starting devices. Such testing shall be possible without interfering with other aspects of the ship's operation.

1.6 For the rating and control of the emergency generators, the same principles apply as for the main generators in accordance with [B.2](#). Unlike in [B.2.4](#), voltage deviations of  $\pm 3,5\%$  under steady conditions and of  $\pm 4\%$  under transient conditions after 5 second are acceptable.

1.7 Regarding electric starting equipment, see [Section 7.D.6](#).

1.8 Where fins of stabilizing systems are in the area of embarking stations of life boats, these systems and indicators on the navigation bridge shall be connected to the emergency source of power.

### 2. Emergency electrical power supply on passenger ships

Regarding emergency electrical power supply on passenger ships, see [Section 14.C](#).

### 3. Emergency electrical power supply on cargo ships

3.1 All cargo ships of 500 GT and over are to be provided with a self-contained emergency source of electrical power.

**3.2** With due allowance for starting currents, the emergency source of electrical power shall be capable of simultaneously supplying at least the following services for the period specified below, if their operation depends upon an electrical source:

**3.2.1** For 3 hours, the emergency lighting at every embarkation station for survival craft and rescue boats on deck and along the ship's sides in this area.

**3.2.2** For 18 hours, the emergency lighting

- 1) in all service and accommodation alleyways, on stairways, at exits and in personnel lift cars and shafts
- 2) in engine rooms and main generator stations, including their control positions
- 3) in all control stations, bridge, engine control rooms and at each main and emergency switchboard
- 4) at all stowage positions for firemen's outfits
- 5) in the steering gear compartment, and the CO<sub>2</sub> room
- 6) at the fire pump mentioned in 3.2.5, at the sprinkler pump, if any, the emergency bilge pump, if any, and at the start-up position for their motors
- 7) in all cargo pump-rooms of tankers

**3.2.3** For 18 hours

- 1) the navigation lights and other lights required by the current "International Regulations for Preventing Collisions at Sea"
- 2) the VHF radio installation required in SOLAS Chapter IV and, where provided, the MF radio installation, as well as the ship earth station and the MF/HF radio installation

**3.2.4** For 18 hours

- 1) all internal signalling and communications equipment required in an emergency
- 2) all ship's navigational appliances stipulated by SOLAS Chapter V/ Regulation 12
- 3) the fire detection and fire alarm system
- 4) the intermittent operation of the daylight signalling lamp, the ship's whistle, the manually operated fire alarms and all the internal signals required in an emergency, e.g. general alarm, and CO<sub>2</sub> alarm

unless these services can be independently supplied during this 18-hour period by an emergency storage battery.

**3.2.5** For 18 hours

- 1) the required emergency fire pump
- 2) the water-spraying systems for machinery spaces of category A and cargo pump rooms
- 3) the auxiliary equipment for the emergency generator set
- 4) at least one bilge pump for cargo spaces on open-top container ships

**3.2.6** The steering gear for the time specified in Section 7.A.2., where an emergency supply is stipulated, and also the rudder angle indicator.

**3.3** In the case of ships which regularly undertake voyages of limited duration, the National Authorities may accept a period shorter than the 18 hours specified in 3.2.2 - 3.2.5, but not less than 12 hours, if they are satisfied that this ensures an adequate standard of safety being attained.

Dispensation to the reduced period of availability of the emergency source of power can be given to:

- Ships with a class notation Coastal Service “L”.
- Ships engaged in voyages where the route is no greater than 20 nautical miles offshore.

**3.4** The emergency source of electrical power for cargo ships may be either a generator set or a storage battery.

**3.4.1** Where the emergency source of electrical power is a generator set, it shall be driven by a suitable prime mover with its own independent fuel supply in accordance with Rules for Machinery Installations, (Pt.1, Vol.III) Sec.10 and with an independent cooling system.

The set shall start up automatically if the main source of electrical power fails, and the supply of the listed consumers shall be automatically taken over by the emergency generator set, unless a transitional emergency power source in accordance with 3.4.2 is provided.

The emergency supply of electrical power shall come into operation as quickly as possible, and in any event not later than 45 seconds after the failure of the main source of electrical power.

**3.4.2** The transitional source of emergency electrical power shall be a storage battery which, in the event of failure of the main source of electrical power, automatically and immediately supplies the consumers listed below until the emergency generator set described in 3.4.1 is put into operation and connected.

Its capacity shall be sufficient to supply the consumers for a period of at least 30 minutes, during which time the battery voltage shall remain within  $\pm 12\%$  of the rated voltage, without intermediate recharging.

Where called for and dependent on an electrical power source, the following consumers are to be supplied:

- 1) the lighting specified in 3.2.1, 3.2.2 and 3.2.3.1). The necessary emergency lighting of the machinery space and the accommodation and service spaces can be provided by permanently fixed, self-contained, battery-powered lamps and
- 2) all the services specified in 3.2.4.1), 3.2.4.3) and 3.2.4.4), unless such services are independently supplied for the prescribed period by an emergency storage battery

**3.4.3** If the emergency source of electrical power is a storage battery, it shall meet the functional requirements stated in 3.4.2.

#### **4. Emergency consumers protecting the main propulsion plant**

In rating the emergency source of electrical power, consideration is to be given, where applicable, to other consumers required to protect the main propulsion plant in the event of a failure of the main source of electrical power. Such consumers may, for example, include the emergency lubricating oil supply and the turning gear on turbine plant. The measures to be taken are to be agreed with BKI in each particular case.

#### **5. Emergency electrical power supply for special purpose ships in accordance with IMO-Resolution MSC.266(84)**

**5.1** Within the meaning of this Section, “special purpose ships” are ships of 500 GT and over in which 12 persons apart from the crew are carried for an extended period for the performance of special tasks. They include, for example, research ships, drilling vessels, etc. Consideration is given to the number of additional personnel and to the size of the ship when deciding whether the ship is to be treated as a cargo ship or a passenger ship for the purpose of its emergency electrical power supply.

**5.2** “Special purpose ships” not more than 50 metres in length and carrying not more than 60 persons on board are treated as cargo ships in accordance with 1. and 3.

5.3 If the length of the ship is greater than 50 metres, the closure system for watertight doors in bulkheads and its indicators are to be connected to the emergency electrical power supply, as on passenger ships in accordance with [Section 14](#).

5.4 With regard to their emergency power supply, "special purpose ships" carrying more than 60 persons on board are to be treated in every respect as passenger ships in accordance with [Section 14](#).

## D. Operation of the Emergency Generator in Port

### 1. General

The emergency generator may be used during lay time in the harbour for the main power supply, provided the undermentioned requirements are complied with (see also [C.1.3](#)).

### 2. Requirements

2.1 The independence of the emergency power supply from other auxiliaries of the main engine plant shall be ensured during manoeuvring in port, during estuary trading and during sea service.

2.2 The emergency diesel-generator shall be protected against overload by tripping of the transferline. If necessary, a tripping of non-emergency load shall be provided to ensure continued safe operation of the generator set.

2.3 The emergency power supply installations shall be arranged and protected in such a way that an interruption of cables, as short-circuit or an earth-fault caused by fire or by another event neither in spaces where the components of main electrical power supply with their associated accessories are installed nor in other machinery spaces of category A will not interfere with control, monitoring, auxiliary power supply and power distribution of the emergency electrical power supply.

If required for safe operation selector switches with switching positions port operation emergency operation shall be provided in the emergency switchboard, see [Section 5.C.3.2](#).

2.4 The location where the emergency generator set and the emergency switchboard are installed shall be covered by means of a fire detections system similar to those required for unattended main and auxiliary machinery spaces, see [Section 9.D.3.5](#).

2.5 The prime mover shall be designed for continuous operation and shall be subject to planned maintenance in order to ensure its operational readiness in case of emergency.

The prime mover and the generator shall be provided with monitoring, protective and safety devices as required for auxiliary engines and main generators intended for unattended operation, e.g. stop at lubricating oil pressure too low.

The prime mover shall be equipped with switch-over filters (2 or more filter chambers, e.g. Duplex-filter) for fuel oil and lubrication oil which enable cleaning during operation.

2.6 The fuel oil supply tank to the emergency/ port diesel generator set shall be provided with a lowlevel alarm arranged at a level of fuel sufficient for a duration of operation required acc. to [C.3](#). respectively [Section 14.C.1](#). The volume of the fuel tank shall be sufficient for 24 hours of unattended operation and in addition for the above required duration of emergency operation (SOLAS).

#### Note

*For a cargo ship intended for unrestricted service is a fuel oil supply tank required with a capacity sufficient for 42 hours of operation (24 hours of unattended operation in port as a port diesel generator set and additional 18 hours operation as an emergency diesel generator set). The level alarm has to be arranged at a level sufficient for not less than 18 hours of operation. If the fuel oil supply tank is arranged for automatically refilling, the amount of fuel oil for 24 hours of operation is not required.*

### 3. Operation manual

An operation manual shall be provided on board containing the conditions for the operation and ensure that when the vessel is under way all control devices (e.g. valves, switches) are in a correct position for the independent emergency operation of the emergency generator set and emergency switchboard.

#### **Note**

*This operation manual shall also contain information on required fuel oil tank level, position of harbour/ sea mode switch if fitted, ventilation openings, etc.*

*This page intentionally left blank*



## Section 4 Installation Protection and Power Distribution

A.	Three-Phase Main Generators . . . . .	4-1
B.	Emergency Three-Phase Generators . . . . .	4-4
C.	Direct Current Generators . . . . .	4-4
D.	Power Transformers . . . . .	4-4
E.	Storage Batteries . . . . .	4-5
F.	Power Electronics . . . . .	4-5
G.	Shore to Ship Connection . . . . .	4-5
H.	Consumer Protection Equipment . . . . .	4-7
I.	Power Distribution . . . . .	4-7

### A. Three-Phase Main Generators

#### 1. General

The main generators supply the relevant main switch-board, either individually or in parallel.

##### 1.1 Single operation

Single operation means that each generator supplies a busbar system assigned to it. Where this method is used, it shall be possible to connect the consumers or consumer groups to at least two different busbar systems or generators by means of selector switches.

##### 1.2 Parallel operation

In parallel operation, the generators supply a common busbar system of the main switchboard, to which the consumer feeders are connected.

#### 2. Protection equipment

##### 2.1 General

2.1.1 Generators shall be at least protected against damage due to short-circuits and overloads.

2.1.2 Protection equipment for generators is to be arranged within the switch-gear field of the generator to be protected and supplied from the generator side.

2.1.3 Short-circuit protection and overload protection equipment is to be provided in every nonearthed conductor.

##### 2.2 Short-circuit protection

2.2.1 The short-circuit protection is to be set at an overcurrent of more than 50%, but at a value less than the steady short-circuit current (preferably  $2,8 \times I_n$ ). It shall have a short time delay compatible with the selectivity of the system (from 300 up to about 500 ms).

2.2.2 The short-circuit protection shall not be disabled by under-voltage.

**2.2.3** Generators with a rated output of 1500 kVA or more are to be equipped with a suitable protective device which in the event of a short-circuit inside the generator or in the cable between generator and circuit-breaker opens the breaker and de-energizes the generator.

Examples of suitable protective equipment are differential protection or generator-neutral-point monitoring.

## **2.3 Overload protection**

**2.3.1** The overload protection, which is to be set to a value between 10 % and 50 % overcurrent, shall trip the generator circuit breaker with a time delay of not more than 2 minutes. A setting above 50 % overcurrent may be allowed, where this is required by the working conditions and is compatible with the generator characteristics. The overload protection shall not impair immediate reconnection of the generator.

**2.3.2** A device shall be installed which, when the generator's rated current is exceeded, cause a warning signal after about 5 seconds and automatically disconnects the non-essential and if necessary, the secondary essential equipment, excluding those required for maintaining ship's safety, e.g. lighting systems, position and navigation lights, aids and signals and internal safety communication equipment

On passenger ships and ships with unattended machinery spaces the automatic disconnection of nonessential consumers is mandatory.

## **2.4 Reverse-power protection**

**2.4.1** Generators from 50 kVA output upwards provided for parallel operation are to be protected by a delayed reverse-power release

**2.4.2** The protection shall be selected and set in accordance with the characteristics of the prime mover. Setting guidance values are: for turbo-generators 2 % to 6 %, for diesel generators 8 % to 15 % of the rated output delayed from 2 to 5 seconds. The setting should, if possible be at 50 % of the tractive power of the prime mover. Should the operating voltages decrease to 50 % of the rated value, the reverse-power protection shall remain effective within the limits stated.

## **2.5 Under-voltage protection**

Generator circuit-breakers are to be provided with under-voltage protection. In the event of a decrease of the voltage to 70 % - 35 % of the rated voltage, the generator circuit-breaker shall open automatically. Under-voltage releases shall have a short-time delay adapted to the short-circuit protection.

## **2.6 Over-voltage protection**

The ship's mains shall be protected against over-voltage. The voltage shall be limited to 130 %  $U_N$  and max. 5 seconds even in the case of failure of the voltage regulators.

## **2.7 Under-frequency protection**

**2.7.1** In the event of a continuous frequency drops of more than 10 %, the non-essential and, where necessary, the secondary essential equipment shall be tripped within 5 to 10 seconds. If this fails to establish normal operating condition, the supplying generators shall be disconnected from the power supply so that the stand-by unit can cut in.

**2.7.2** For shaft-driven generator plants protection shall be provided in accordance with [Section 3.B.4](#) for disconnecting the generators in the event of under frequency.

## **2.8 Testing**

Generator protection devices are subject to mandatory type approvals.

### 3. Switchgear

#### 3.1 General

**3.1.1** Each non-earthed conductor shall be switched and shall be protected against short-circuit and overload.

**3.1.2** When tripped due to overcurrent, generator circuit breakers shall be ready for immediate reconnection. The use of thermal bi-metallic release for generators used to supply essential consumers is not permitted.

**3.1.3** Generator circuit breakers shall be provided with a reclosing inhibitor which prevents automatic re-closure after tripping due to a short-circuit.

**3.1.4** In the design of the contactor to supply primary essential consumers the low voltage switching devices shall be dimensioned in accordance with IEC 60947-4-1 "type 2".

**3.1.5** Is the personnel security ensured and the selective protection of the electrical system by devices in series guaranteed in this case the low voltage switching devices for supplying secondary essential and less important consumers could be dimensioned in accordance with IEC 60947-4-1 "type 1".

#### 3.2 Single operation

The following devices are to be provided:

- a three-pole circuit breaker with time-delayed overcurrent-and short-time-delayed short-circuit release.
- for generators with a rated output below 50 kVA, fuses and load switches or fuses with contactors are also permitted.

All generator contactors that may be used are to be provided with a dropout delay (up to approx. 500 ms) and shall be rated for double of the generator current.

#### 3.3 Parallel operation

The following devices are to be provided:

- For each generator, a three-pole circuit breaker with delayed overcurrent and short-time-delayed short-circuit and under-voltage release
- In the case of generators intended for parallel operation, the generator switch is to be provided with under-voltage protection which prevents closing of the switch if the generator is dead.
- A single-fault event in the synchronization circuit or in the black-out monitoring shall not lead to an asynchronous connection.

### 4. Synchronizing equipment

Generators intended for parallel operation shall be equipped with a synchronizer in accordance with [4.1](#) and [4.2](#).

#### 4.1 Equipment to prevent faulty synchronizations

Generators intended for parallel operation shall be provided with automatic synchronizing equipment. Instead of automatic equipment, semiautomatic synchronizing equipment combined with a check synchronizer may be provided. The conditions of [Section 20.E.4.8](#) shall be complied with in order to prevent faulty synchronization.

## 4.2 Manual synchronization

Manual synchronization (e.g. synchronizing dark method installed within sight of the generator-switch actuating position) shall be possible if the appliances listed in 4.1 fail.

## B. Emergency Three-Phase Generators

Emergency generators supply the emergency switch-boards and the connected emergency consumers.

### 1. Protective equipment and switchgear

Generator protection shall consist of at least:

- short-circuit protection
- overload protection
- under-voltage protection.

However, it is permissible for the overload protection not to disconnect the generator automatically but instead to trigger an optical and acoustical warning signal at the emergency switchboard and at the main switchboard

### 2. Overload shedding

If the emergency generator is overloaded, consumers temporarily supplied from the emergency switchboard which are not emergency consumers shall be automatically disconnected in order to safeguard the supply to the emergency circuits.

## C. Direct Current Generators

### 1. Single operation

The following devices are to be provided:

For each generator, a circuit breaker which simultaneously switches all non-earthed poles, with a delayed overcurrent release and a short-time-delayed short-circuit release, or a fuse in each non-earthed pole and a spring-operated load-switch with sufficient breaking capacity.

Circuit breakers are always to be used for generators with outputs of 50 kW and over.

### 2. Parallel operation

The following facilities are to be provided:

- For each generator, a circuit breaker which simultaneously switches all non-earthed poles, with a delayed overcurrent release and a short-time-delayed short-circuit release, together with a reverse-current protection and short-time-delayed under-voltage protection
- For compound generators, the switch shall contain a switching element for the equipotential line which, when switching on, closes simultaneously or earlier and, when switching off, opens simultaneously or later, and is rated for at least half the rated current.
- A polarity-reversing facility for each generator

## D. Power Transformers

1. Transformers intended for parallel operation shall be so designed that over the whole load range the load on no transformer deviates by more than 10 % of its nominal current from the percentage share calculated for it.

2. Transformers shall be protected against short-circuit and overload. When transformers are connected in parallel, tripping of the protective devices at the primary side has to automatically trip the switch connected at the secondary side.

3. Transformers shall be switchable on the primary side.

In installations where feedback is possible transformers shall be switchable at both, the primary and secondary side.

4. Each of the secondary circuits is to be provided with a multipole isolating switch.

### E. Storage Batteries

Section 2.C. is to be observed.

### F. Power Electronics

1. Power electronics facilities are to be protected against overload and short-circuits.

2. Inverters intended for the supply of emergency consumers from the emergency battery shall be designed for continuous operation.

### G. Shore to Ship Connection

#### 1. Application

The requirements in this sub-section are applied to ship utilized with shore connection system intended to supply the ship with shore power only, enabling the ship's main power source to be shut down while in port.

The shore power voltage is divided into Low Voltage (LV) which is the system voltage is up to 1000 V and High Voltage (HV) with system voltage more than 1000 V.

Requirements in Annex A of the Rules are also be applied for specific type of class notation, see 2.

#### 2. Class notation

Ships found to be in compliance with the requirements in this sub-section as well as requirements in Annex A will be assigned with additional notation **SP (LV)**.

Ship that has been equipped with shore connection system may be eligible with additional class notation **SP (Ready)**, provided that the requirements of this sub-section and sub-section A, D of Annex A are complied.

**Table 4.1: Notation requirements**

Section	SP (LV)	SP (Ready)
4.G	X	X
Annex A, A (General)	X	X
Annex A, B (Shore Installation)	X	
Annex A, C (Ship to Shore Connection and Interface)	X	
Annex A, D (Ship Installation)	X	X
Annex A, E (Testing and Trials)	X	

**3. Document to be submitted**

3.1 The following document are required:

**Table 4.2: Documents to be Submitted**

No.	Notation requirements	Note
1	Overall One line diagram of the Shore Connection system	AP
2	General arrangement showing the location of the connection equipment, cabinets, routing of the cables, movable parts, openings and accesses	AP
3	Services to be supplied and electrical load analysis in shore supply condition	AP
4	Selectivity and coordination of the electrical protections	FI
5	Diagrams of control, alarm, and safety systems	AP
6	Operating manuals describing the method of connection, the operating and the monitoring instructions (including the interlocking procedure of earth-switches, breakers)	FI
7	Operational and construction details of Connection Equipment, including any flexible or adjusting arrangements, including plugs and socket-outlets	FI
8	Environmental conditions having consequences on the shore connection (weather, tides, mooring arrangement)	FI
9	Details of type tests for Connection cables, plugs and socket-outlets	AP
10	Details of supplementary arrangements required to protect equipment from exposure to moisture, condensation or temperatures outside their rating	FI
11	Schedule of testing at manufacturers' works, initial surveys and trials	AP, FI
Note: AP : for approval FI : for information		

3.2 When the approved arrangements are intended to be modified, details are to be submitted to BKI for examination.

**4. General requirements**

4.1 Terminal boxes for shore supply shall be linked to the ship's system by permanently laid cables

4.2 A device for connecting a protective conductor or a potential equalizer has to be provided, if required.

4.3 Switching-on of the shore supply shall only be possible if the switches of the main generators have been shut-off. Short-term parallel operation of the ship's mains and the shore mains for load transfer is permissible.

4.4 The shore connection shall be switchable, and it shall be protected against short-circuit and overload. The terminal box for shore connection shall be provided at least with short-circuit protection.

4.5 A voltage indicator shall be provided in the main switchboard.

4.6 Facilities shall be provided to compare the polarity (in the case of direct current) and the phase sequence (in the case of three-phase alternating current) of the shore supply with those of the ship's mains.

4.7 The following details shall be indicated on a plate fitted to the shore connection box: voltage system and rated voltage, and the frequency in the case of alternating current.

## H. Consumer Protection Equipment

### 1. General

1.1 Protective equipment shall be so selected and co-ordinated with the generator protection that in the event of a short-circuit the selectivity is safeguarded. If necessary, the evidence is to be proved.

1.2 Every non-earthed conductor in a distribution circuit shall be protected against overload and short-circuit.

1.3 Where the three-phase system is isolated from the hull the over current protection can be realized in only 2 conductors, if the disconnection of all phases is safeguarded.

### 2. Final supply circuits

#### 2.1 Circuit breakers and motor protection switches

For a final circuit supplying one consumer with its own overload protection, it is permissible to provide short-circuit protection only at the input point. In this case, fuses two ratings higher than those permissible for rated operation of the consumer may be used for continuous duty.

In the case of short-time and intermittent operation, the rated current of the fuses shall not be greater than 160 % of the rated current of the consumer. The associated switches are to be selected in accordance with the fuse current ratings.

2.2 Where circuit breakers are used, the short-circuit cut-out may be adjusted to a maximum of 15 times the rated current of the consumer, though not higher than the anticipated minimum value of the initial short-circuit alternating current in the circuit concerned. For steering gear equipment circuits, see [Section 7.A](#).

2.3 Circuit breakers and motor protection switches with insufficient switching capacity shall be fitted with the back-up fuses specified by the manufacturer. Automatic circuit breakers without a selectively graded breaking delay may not be connected in series in a single line.

2.4 Final supply circuits for lighting shall not be fused above 16 A. Regarding the number of lighting fixtures connected to a circuit, see [I.5](#).

## I. Power Distribution

### 1. Electrical supply systems

1.1 Regarding permissible supply systems, see [Section 1.G](#).

#### 1.2 Supply systems with hull return

1.2.1 All final supply circuits shall have all-pole insulation. The return conductors are to be connected in the associated distribution switchboard to an insulated busbar, which is connected to the hull

1.2.2 The connections to the hull shall have at least the same cross-section as the supply cable.

Bare wires shall not be used. Casings or their mounting bolts shall not be used as return conductors or to make their connection.

1.3 Up to 3 distribution switchboards may be supplied by a common supply cable.

## 2. Load balancing in three-phase systems

Where, in three-phase systems, AC-consumers are connected between two outer conductors or one outer conductor and the neutral, the consumers are to be distributed in such a way that, under normal operating conditions, the loads on the individual outer conductors do not differ from each other by more than 15%, see [Section 12.C.5](#).

## 3. Essential supply cables

**3.1** Primary and secondary essential equipment shall be preferably supplied direct from the main or emergency switchboard in accordance with the Rules. Supply via distribution panels is only permissible if an equivalent safety of supply is guaranteed, see also [Section 2.A.3](#).

**3.2** Primary and secondary essential equipment for the same function (e.g. main and stand-by lubricating oil pumps) are to be fed via two separate cables from the main switchboard or from two independent sub-distribution panels.

Exempt from this request are central power supplies for cargo refrigeration plants on refrigerated cargo vessels and systems for cargo maintaining on gas tankers.

Regarding supply to steering gear, see [Section 7.A](#).

## 4. Emergency supply cables

**4.1** Emergency consumers shall be supplied directly from the emergency switchboard or via sub-distribution panels, to which only consumers in the relevant fire zone are connected.

**4.2** In normal operation, the emergency switch-board shall be supplied by an interconnection feeder from the main switchboard. The feeder is to be protected against overcurrent and short circuits at the main switchboard, and the feeder shall be automatically disconnected in the emergency switchboard if the supply from the main switchboard fails.

**4.3** A return supply from the emergency switchboard to the main switchboard, e.g. when starting operation from dead ship condition or under observance of [Section 3.D](#). for harbour operations, is permitted. For return supply operation, the automatic feeder disconnection called for in [4.2](#) may be temporarily overridden.

## 5. Supply of lighting systems

**5.1** Main lighting installations shall be supplied from the main switchboard, emergency lighting installation from the emergency switchboard.

**5.2** The number of lighting points (lamps) connected to one final circuit shall not exceed:

- 10 lamps for voltages up to 55 V
- 14 lamps for voltages over 55 V
- 24 lamps for voltages over 125 V

**5.3** Switches shall simultaneously switch all non-earthed conductors. Single-pole switching of final circuits for lighting in systems with all conductors insulated is permitted only in the accommodation area.

**5.4** Sockets outside the accommodation area shall be connected to separate circuits. When calculating the permissible connected load, one socket is equivalent to two lighting points.



5.5 In the areas listed below, the lighting shall be supplied by at least two separate fused circuits:

- main engine rooms, service spaces and control stations
- large galleys
- passageways and alleys
- stairways leading to the boat deck
- saloons and lounges for passengers and crew
- pump rooms on tankers

5.6 The lighting fixtures shall be so arranged that sufficient illumination for orientation is maintained should one circuit fail.

## 6. Navigation and signalling lights

6.1 The masthead, side and stern-lights are separate to be supplied from the navigation lights controller. Each circuit shall be protected against overload and short-circuit.

Masthead lights, sidelights and stern lights are to be approved by administration in accordance with COLREG part C.

The individual main and reserve lights may have separate circuits in a common cable.

6.2 The navigation lights controller may be extended for the supply of the signalling lights specified in the "International Regulations for Preventing Collisions at Sea (COLREGs)".

Other consumers shall not be connected to this panel.

6.3 Navigation and signal light controller shall be supplied from the main and emergency electrical power source. An automatic switch over to the alternative source of power is permitted and to be alarmed

6.4 A navigation lights controller should facilitate ON/OFF controls of individual Navigation lights.

6.5 A navigation lights controller should provide visual indications of "ON"/"OFF" status of Navigation lights.

6.6 Pre-programmed navigation lights group settings may be provided.

6.7 The navigation lights controller shall be provided with a device for each light which gives optical and acoustical alarm if the light disappears.

Where the monitoring device is connected in series with the navigation light, it shall be ensured that a failure of the device does not cause the navigation light to disappear.

6.8 A navigation lights controller shall present the status of all navigation lights in a logical presentation, meeting the requirements set out in IMO Resolution MSC.191(79).

6.9 All indicators of a navigation lights controller shall be dimmable. The brightness of a display, if fitted, shall be controllable.

6.10 To prevent shortage of luminous intensity of LEDs (Light Emitting Diodes) an alarm function should be activated to notify the Officer of the Watch that the luminous intensity of the light reduces below the level required by COLREGs or LEDs shall only be used within the lifespan (practical term of validity) specified by the manufacturer to maintain the necessary luminous intensity of LEDs. The specifications in the certificate of conformity for navigation lights are to be observed.

6.11 Where navigation lights are supplied from the main source of electrical power, the voltages at the lamp-holders shall not permanently deviate by more than 5 % above or below the rated voltage.

Where, in the event of a failure of the main electric power, navigation lights are supplied from the emergency source of electrical power, the voltages at the lamp-holders may temporarily deviate by up to 10 % above or below the rated voltage.

## 7. Control, monitoring and ship's safety systems

The supply of control, monitoring and ship's safety systems shall comply with the following requirements (see additionally [Section 9.B.](#)):

**7.1** These systems shall be supplied by their own circuits.

Provision shall be made for the selective disconnection of the separate circuits in case of a short-circuit.

**7.2** A common distribution network with back-up batteries may be used to supply systems which are required to remain operative even if the main source of electrical power fails. Such a network shall have two supply units comprising either:

**7.2.1** A power supply unit with a capacity sufficient for all the connected consumers together with a charger which, acting in buffer operation with the back-up battery, is capable of supplying continuously all the connected consumers and maintain the battery in the charged condition or

**7.2.2** Two chargers, which meet the conditions stated in [7.2.1](#).

**7.3** With regard to residual ripple, the supply facilities specified in [7.2.1](#) and [7.2.2](#) shall be designed to ensure trouble-free operation of the connected systems even when the battery is temporarily disconnected.

**7.4** One of the power supply units or chargers shall be supplied directly from the main switchboard.

**7.5** Failure of the power supply units and chargers shall be signalled visually and audibly.

**7.6** Battery chargers with a charging capacity of  $P \geq 2$  kW shall be tested at the maker's works in the presence of the Surveyor.

## 8. Emergency shutdown facilities

Emergency shutdown facilities placed outside the sites at which the equipment is installed are to be provided for the following consumers. The consumers may be arranged in groups, provided that redundant consumers are allocated to at least two electrically independent groups.

Emergency shutdown facilities are to be provided for e.g.

- fuel pumps
- lubrication oil pumps
- oil burner plants
- separators
- fan motors
- boiler blowers
- auxiliary blowers for main engines
- thermal oil pumps

(see [Rules for Machinery Installations \(Pt.1, Vol.III\) Sec.12.B.9.](#))

## 9. Radio and navigational equipment

### 9.1 General

The main and emergency electrical power sources shall at any time maintain a sufficient supply of power to operate the radio equipment and to charge all reserve power sources for the radio equipment.

**9.1.1** The radio and navigational equipment shall be directly supplied from both the main source of electrical power and the emergency source of electrical power by separate power supply circuits.

**9.1.2** The power distribution for radio equipment shall be independent of that for the navigational equipment. The circuits from both the main and the emergency source of electrical power shall be terminated either in one or two distribution panels. If one distribution panel is used, the two circuits supplying the panel shall be provided with splitter feeding into two separate bus bars, one for the radio equipment and one for the navigational equipment. The panel(s) shall be located at the navigating bridge or other suitable position on the bridge deck.

**9.1.3** Facilities shall be provided in each distribution panel for changing over between the main source of electrical power and the emergency source of electrical power. It is preferable that changeover be initiated automatically. If a single distribution panel is used for both the radio and the navigational equipment, separate change over switches shall be provided.

**9.1.4** Failure of any power supply shall initiate an alarm at the navigational bridge.

## **9.2 Radio equipment**

**9.2.1** A reserve source or sources of energy shall be provided to supply radio equipment, for the purpose of conducting distress and safety radio communications, in the event of failure of the ship's main and emergency sources of electrical power.

**9.2.2** Further stipulations for the reserve source of energy are to be taken from the SOLAS Convention, Chapter IV and relevant IMO guidelines.

## **9.3 Navigational equipment**

Where radio equipment requires an uninterrupted input of information from the ship's navigational equipment, it will be necessary for the equipment providing the data to be supplied from the same distribution board bus bar serving the radio equipment.

## **10. Sound signalling system**

The ship's sound signalling system shall remain operative if the electrical main power supply fails.

## **11. Harmonic distortion for electrical distribution system and harmonic filter <sup>1)</sup>**

**11.1** The total harmonic distortion (THD) of electrical distribution systems is not to exceed 8 %.

This limit may be exceeded where all installed equipment and systems have been designed for a higher specified limit and this relaxation on limits is to be documented (harmonic distortion calculation report) and made available on board as a reference for the surveyor at each periodical survey.

### **11.2 Monitoring of harmonic distortion levels including harmonic filter**

**11.2.1** Where the electrical distribution system on board a ship includes harmonic filters, such ships are to be fitted with facilities to continuously monitor the levels of harmonic distortion experienced on the main busbar as well as alerting the crew should the level of harmonic distortion exceed the acceptable limits. Where the engine room is provided with automation systems, this reading should be logged electronically, otherwise it is to be recorded in the engine log book for future inspection by the surveyor. However, harmonic filters installed for single application frequency drives such as pump motors may be excluded from these requirements.

<sup>1)</sup> Paragraph 11.2.2 is to be implemented for ships contracted for construction before 1 July 2017, at any scheduled Machinery periodical survey having a due date on or after 1 January 2017.

**11.2.2** As a minimum, harmonic distortion levels of main busbar on board such existing ships are to be measured annually under seagoing conditions as close to the periodical machinery survey as possible so as to give a clear representation of the condition of the entire plant to the surveyor. Harmonic distortion readings are to be carried out when the greatest amount of distortion is indicated by the measuring equipment. An entry showing which equipment was running and/or filters in service is to be recorded in the log so this can be replicated for the next periodical survey. Harmonic distortion levels are also to be measured following any modification to the ship's electrical distribution system or associated consumers by suitably trained ship's personnel or from a qualified outside source.

Records of all the above measurements are to be made available to the surveyor at each periodical survey.

### **11.3 Mitigation of the effects of harmonic filter failure on a ship's operation**

Where the electrical distribution system on board a ship includes harmonic filters the system integrator of the distribution system is to show, by calculation, the effect of a failure of a harmonic filter on the level of harmonic distortion experienced.

The system integrator of the distribution system is to provide the ship owner with guidance documenting permitted modes of operation of the electrical distribution system while maintaining harmonic distortion levels within acceptable limits during normal operation as well as following the failure of any combination of harmonic filters.

The calculation results and validity of the guidance provided are to be verified by the surveyor during sea trials.

### **11.4 Protection arrangements for harmonic filters**

Arrangements are to be provided to alert the crew in the event of activation of the protection of a harmonic filter circuit.

A harmonic filter should be arranged as a three-phase unit with individual protection of each phase. The activation of the protection arrangement in a single phase shall result in automatic disconnection of the complete filter. Additionally, there shall be installed a current unbalance detection system independent of the overcurrent protection alerting the crew in case of current unbalance.

Consideration is to be given to additional protection for the individual capacitor element as e.g. relief valve or overpressure disconnecter in order to protect against damage from rupturing. This consideration should take into account the type of capacitors used.

## Section 5 Low-Voltage Switchgear Assemblies

A.	General . . . . .	5-1
B.	Calculations . . . . .	5-1
C.	Construction . . . . .	5-3
D.	Selection of Switchgear . . . . .	5-6
E.	Choice of Electrical Protection Equipment . . . . .	5-7
F.	Conductors and Busbar Carriers . . . . .	5-10
G.	Measuring Instruments and Instrument Transformers . . . . .	5-12
H.	Testing of Switchboards and Switchgear . . . . .	5-12

### A. General

1. These Rules apply to low-voltage switchgear with operating voltages of up to 1000 V AC or 1500 V DC.
2. Electrical installations are to be protected against damage due to overloading and short-circuit.
3. The thermal and electro-dynamic stresses due to overcurrents shall not cause damage to parts of the installation during the response time of protective devices or during the total operating time of switches.
4. Overcurrent protective devices are to be selected on the basis of the following criteria:
  - overload current
  - short-circuit current
  - reclosing capability
5. Regarding design, construction and testing of low-voltage switchgear assemblies' attention is drawn to IEC 60092-302.
6. For further notes, see [Section 4](#).

### B. Calculations

#### 1. Calculation of short-circuit currents

1.1 Short-circuit current calculations are to be carried out in accordance with a standard accepted by BKI, e.g. IEC 61363-1 as amended.

#### Note

*A computer-backed calculation program is obtainable from BKI.*

1.2 When calculating the maximum short-circuit currents to be expected, the following are to be taken into account:

- all generators which operate in parallel to provide the maximum power demand
- all motors whose simultaneous operation shall be expected.

All data used for the short-circuit current calculation are to be submitted.

To be determined are:

- the peak short-circuits current  $i_p$
- the initial symmetrical short-circuit current  $I''_k$

1.3 Roughly, the short-circuit currents at the main busbar can be calculated as follows:

$$1.3.1 \quad I''_{kG} = \frac{I_{rG} \cdot 100}{x_d''(\%)}$$

$I''_{kG}$  = initial symmetrical short-circuit current of a generator  
 $I_{rG}$  = rated current of the generator  
 $x_d''$  = sub-transient of the generator in percent

$$1.3.2 \quad I''_{kM} = 6 \cdot I_{rM}$$

$I''_{kM}$  = initial symmetrical short-circuit current of a motor  
 $I_{rM}$  = rated current of the motor

1.3.3 The total initial symmetrical short-circuit current can be calculated by summation of the individual component currents.

1.3.4 The value of the peak short-circuit current  $i_p$  can be calculated by multiplying the total initial symmetrical short-circuit current  $I''_k$  by the factor 2,3.

1.4 The short-circuit calculation shall consider all possible short-circuits necessary for an evaluation of the system. The following types of short-circuits are to be investigated in all cases:

- generator short-circuits
- short-circuits on main busbars
- short-circuits on the busbars of emergency switchboards and main distribution panels

1.5 The short-circuit current calculation shall be accompanied by a list of the proposed switching devices and their characteristic data.

The rated making capacity, the rated breaking capacity and the power factor of the switching appliances shall be stated.

1.6 BKI reserves the right also to request proof of the minimum short-circuit currents to be expected.

## 2. Heat losses (heat balance)

Switchgear assemblies shall be so designed that under operational conditions the permissible temperature rise limits in accordance with IEC 60092-302 as amended are not exceeded.

BKI reserves the right to request proof of the heat balance.

## 3. Dynamic and thermal loading

3.1 Switchgear assemblies shall be so designed that no permanent damage to busbars, busbar mountings and the wiring is caused by the dynamic and thermal loading arising in the event of a shortcircuit.

3.2 For systems with a peak current above 220 kA ( $I_{pk}$ ) evidence shall be given for the rated peak withstand current ( $I_{pk}$ ) and the rated short-time withstand current ( $I_{cw}$ ) by a test according to IEC 61439-1 Paragraph 9.3 as amended or equivalent standard.

BKI reserves the right to request proof of the dynamic and thermal stability in the event of a short-circuit.

## C. Construction

### 1. General

1.1 All devices, instruments and operating devices shall be permanently identified by name plates. Wherever possible, clear text shall be used. Fuse current ratings are to be stated. The set-points of adjustable protective devices are to be marked. The rated operating parameters of all measuring instruments shall be marked in red either on the scales or on plates fixed nearby.

1.2 All screwed joints and connections shall be secured against self-acting loosening.

1.3 All conductors shall be secured jig-proof and are to be kept away from sharp edges. Conductors leading to equipment mounted in doors are to be laid tension-free.

1.4 Main and emergency switchboards shall be fitted with insulation hand rails or handles.

1.5 All components including their connections have to be accessible for the purposes of maintenance, repair and replacement.

1.6 Large doors in switchboards shall be fitted with arresting devices.

1.7 Electrical components mounted in the doors of switchboards, e.g. switchgear, measuring devices and fuses for voltages over 50 V, shall be safeguarded against accidental contact. Such doors are to be earthed.

1.8 Where fuses are fitted above switchgear or bare connecting wires or leads, measures are to be taken to ensure that falling parts (e.g. fuse cartridges) cannot come into contact with live components.

1.9 Operating devices and fuses shall be safely accessible.

1.10 For circuit breakers and load-switches, the minimum distances above the arc chutes specified by the manufacturers are to be maintained.

1.11 Knife-type fuses for supply-circuits are only permitted if they can be safely withdrawn and inserted.

### 2. Main switchboards

2.1 Observation of the measuring and indicating devices and operation of the switchgear shall be possible from the front side of the switchboard with the doors closed.

2.2 If the total installed power of all generators exceeds 3 MW, the generator panels shall be separated from each other by arc-resistant partitions. Busbar penetrations shall be flame-retardant and selfextinguishing.

2.3 In plants where the main source of electrical power is necessary for the propulsion of the ship, the main busbar shall be capable to be subdivided into at least two parts which shall normally be connected by circuit breakers or other approved means.

Other approved means can be achieved by:

- circuit breaker without tripping mechanism; or
- disconnecting link or
- switch

by which bus bars can be split easily and safely. Common bolted links between single busbar or switchboard sections (e.g. for transportation) do not fulfil these requirements.

2.4 A single disconnecting device is sufficient if this device is provided within separate switchboard panel without other installations or in an equivalent bounded section, see [Fig. 5.1](#). Otherwise two disconnecting devices are required in different switchboard panels, see [Fig. 5.2](#).

2.5 In case of removable or movable links, these devices shall be easily accessible and simple to handle. Tools for operating shall be located nearby.

2.6 As far as is practicable, the connection of generating sets and other duplicated consumers shall be equally divided between the main busbar sections.

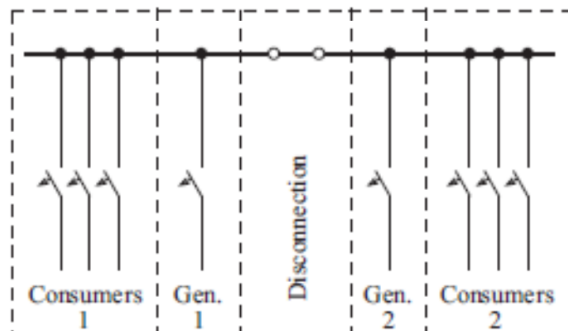

Figure 5.1: Example for arrangement of a main busbar disconnection and division of consumers

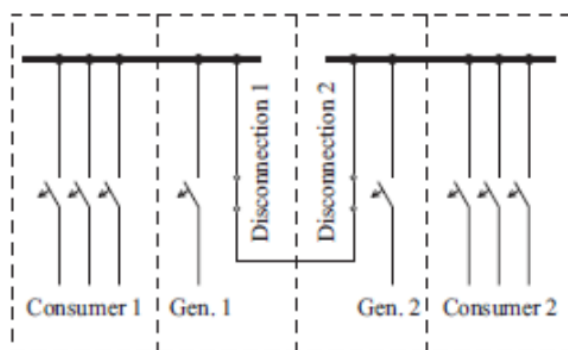

Figure 5.2: Example for arrangement of two disconnecting devices and division of consumers

2.7 The consumers may, for instance, be grouped as follows:

Consumers 1	Consumers 2
Lubricating oil pump 1	Lubricating oil pump 2
Cooling water pump 1	Cooling water pump 2
Lighting 1	Lighting 2
etc.	etc.

**2.8 Switchgear and synchronizing equipment for generators**

See Section 4.A.

**2.9 Measuring and monitoring devices for generators**

2.9.1 Where circuit breakers are used, the following shall be provided:

- 1 indicating light: circuit breaker connected
- 1 indicating light: circuit breaker released

2.9.2 The following is required for each three-phase alternator:

- 1 voltmeter which can, if necessary, be switched to the other alternators
- 1 ammeter, switchable to all phases
- 1 active power meter for alternators of 50 kVA and over
- 1 frequency meter which can, if necessary, be switched to the other alternators



**2.9.3** The following are required for each direct-current generator:

- 1 voltmeter
- 1 ammeter

**2.9.4** The following circuits shall be supplied from the generator side, and shall be separately protected against short-circuits:

- generator protection devices, and the under-voltage trip of the generator circuit breaker
- measuring instruments
- indicating lights
- diesel engine speed-adjusting equipment (The power supply from the governor could be used, if an electronically governor is installed, see [Section 9.B.8.](#))
- motor drive for circuit breaker

**2.9.5** A manual operation is to provide for generator circuit breaker. It shall be independent and overriding, see [Section 21.D.3.4. E.](#)

## **2.10 Switchgear and fuses for equipment**

**2.10.1** Each supply line run from the main switch-board shall be provided with a circuit breaker with overcurrent and short-circuit protection, or with a fuse for each non-earthed conductor and an all-pole switch, or with a contactor with control switch. Where fuses and switches are used, the sequence busbarfuse-switch is to be used. The specified sequence may be changed where motor switches of utilization category AC-23 A are used as load switches, provided that the switches are weld-proof in the event of a short-circuit (see [B.3](#)).

The rated peak withstands current (dynamic limiting current) of switches shall be greater than the cut-off current of the associated fuse in the event of a short-circuit.

**2.10.2** For steering gear, see also [Section 7.A.](#)

## **2.11 Measuring instruments**

The main switchboard and the main distribution panel have to be fitted with ammeters for major consumers, unless these are already mounted on the consumers themselves. It is permissible for one ammeter to be switched-over to a number of circuits.

## **3. Emergency switchboards**

**3.1** The requirements for main switchboards apply in analogous manner to emergency switchboards.

**3.2** Control and supply circuits of the emergency electrical power plant shall be so switched and protected that interruptions or short-circuits caused by fire or another event,

- in a space housing the main generators and/or the main switchboard, or
- in a category A machinery space

do not impair the operating ability of the emergency source of electrical power. Where necessary, the emergency switchboard has to be fitted with isolating switches.

## **4. Distribution panels**

**4.1** Distribution panels are to be equipped with the necessary devices for the protection of the connected circuits and for the supply of consumers (see [Section 4](#)).

4.2 Feeder circuits with fuses shall be switched with load switches. In the case of feeder circuits with fuses up to 63 A, load switches may be dispensed with if each connected equipment can be disconnected by a switch fitted nearby.

4.3 For navigation lanterns panel, see [Section 4.1.6](#).

4.4 Distribution panels for the supply of power to container sockets, see [Section 11.C.4](#).

## 5. Motor starters

5.1 Each motor shall be provided with its own switching device.

5.2 It shall be indicated whether the motor is switched on.

5.3 If the switching device does not disconnect all of the live conductors, additional measures are to be taken for the protection of personnel.

5.4 Motors are to be provided with starters if:

- currents or voltage drops higher than those permissible for the system are liable to occur, if connected directly
- this is necessary for the start-up of the motor or the driven machine
- this is required by the design of the generators.

5.5 Starting shall only be possible from the zero position of the starter.

## D. Selection of Switchgear

### 1. General

1.1 Switchgear shall conform to IEC publications, or to another standard approved by BKI.

1.2 Switchgear shall be selected with regard to its rated current, its rated voltage, its thermal and dynamic stability and its switching capacity.

The following shall be observed:

1.2.1 The rated short-circuit making capacity shall be not less than the calculated peak short-circuits current  $i_p$  at the place of installation.

1.2.2 The rated service short-circuit breaking capacity shall be not less than the a.c. component of the short-circuit  $I_{ac}(t)$  at the moment

$$t = \frac{T}{2}$$

#### Note

See also [B.1.](#), *short-circuit currents calculation*.

### 2. Circuit breakers

2.1 Circuit breakers are distinguished according to the utilization categories of IEC 60947-2 as amended into:

#### 2.1.1 Utilization category A

These are circuit-breakers not designed for selectivity under short-circuit conditions with respect to other short-circuit protective devices in series on the load side, e.g. without intentional short-time delay for selectivity under short-circuit conditions, and therefore do not need proof of the rated short-time withstand current ( $I_{cw}$ ).

Application example:

- As consumers circuit-breakers and distribution feeders.

### 2.1.2 Utilization category B

These are circuit-breakers which are designed for selectivity under short-circuit conditions with respect to other short-circuit protective devices in series on the load side, e.g. with intentional short-time delay for selectivity under short-circuit conditions. Such circuit-breakers shall have proof of the rated short-time with-stand current ( $I_{CW}$ ). Utilization category B circuit breakers shall be able to withstand the short-circuit current to be expected where they are fitted, for the duration of at least 500 ms.

Application example:

- As generator circuit-breakers.

### 2.2 Additional requirements for generator circuit breakers:

- Following tripping due to an overcurrent, the breaker shall immediately be ready for re-closing. For this reason, thermal tripping devices are not permitted
- A reclosing block shall prevent automatic re-making of the breaker onto a still persisting short-circuit following tripping due to a short-circuit.

### 2.3 Additional requirement for circuit breakers in IT systems:

- Testing as described in Annex H of IEC 60947-2 as amended is required.

## 3. Load switches

3.1 The current rating of load switches shall be at least equal to that of the fuse protecting the circuit and they shall have a making/breaking capacity in accordance with AC-22 A or DC-22 A (IEC 60947-3 as amended).

3.2 The sequence busbar-fuse-switch should be maintained.

3.3 If the sequence busbar-switch-fuse is chosen, the making/breaking capacity shall match category AC-23 A or DC-23 A (IEC 60947-3 as amended) and attention is to be paid to increased insulation qualities of the switching unit.

## 4. Fuses

4.1 Fuse links shall have an enclosed fusion space. They shall be made of ceramic or other material recognized by BKI as equivalent.

4.2 Fuses may be used for overload protection only up to a rating of 315 A.

Exceptions to this Rule are subject to approval by BKI.

## E. Choice of Electrical Protection Equipment

### 1. General

Protective devices shall be co-ordinated with each other in such a way that, in the event of a fault, the defective circuit is disconnected and the power supply to essential equipment is maintained.

### 2. Short-circuit protection equipment

2.1 The rated short-circuit breaking capacity  $I_{CN}$  of a switching device shall not be less than the maximum current to be broken in the event of a short circuit at the place where the protective device is fitted.

2.2 The rated short-circuit making capacity  $I_{cm}$  of a circuit breaker shall not be less than the maximum instantaneous asymmetric short-circuit current at the place where it is fitted.

2.3 The peak short-circuits strength of a switching unit and its components shall correspond to the maximum short-circuit current which can arise at the place where it is fitted.

2.4 Circuit breakers whose making/breaking capacities are less than the anticipated maximum short-circuit currents are to be protected by back-up fuses of sufficient breaking capacity.

2.5 The circuit breakers are to be selected on the basis of their rated service short-circuit breaking capacity  $I_{CS}$  as follows:

- all circuit breakers which are directly connected to main or emergency switchboard
- all circuit breakers which are installed in the feeder lines for essential services or emergency consumers

Equivalent protection schemes require special approval by BKI.

### 3. Selective arrangement

3.1 The short-circuit protection of essential equipment shall be selective and shall ensure that only the switching device nearest to the fault initiates disconnection of the defective circuit. For this purpose:

- the tripping time of protective devices connected in series shall be carefully coordinated
- the switching devices being capable of carrying the short-circuit current during the total break time of the device plus the time lag required for selectivity
- Exceptions may be permitted in the case of circuits feeding redundant plants or non-essential equipment if selectivity relative to the generator switch is maintained.

### 4. Overcurrent protection devices

The current-time characteristics of overcurrent protection devices shall be compatible with the system components to be protected, and with the requirements of selectivity.

### 5. Allocation of short-circuit and overcurrent protection devices

5.1 Short-circuit protection is required for every non-earthed conductor.

5.2 Overcurrent protection is required for at least one conductor in insulated direct-current and single-phase alternating-current circuits.

Overcurrent protection is required for at least two phases in insulated, load-balanced three-phase circuits

5.3 Overcurrent protection is required for each non-earthed conductor in earthed systems. The continuity of earthed conductors shall not be interrupted by short-circuit or overcurrent protection devices, except in the case of multi pole disconnection devices which simultaneously interrupt all the conductors, whether earthed or not.

5.4 Determined for the overcurrent protection of the entire circuit (switchgear, switchboard wiring, supply cables and equipment) according to regulations is the rated current  $I_n$  of the connected equipment or in the case of grouped supply cables the evaluated total rated current.

### 6. Motor protection

6.1 Motors with a power rating of more than 1 kW shall be individually protected against overloads and short-circuits. For steering-gear motors, see [Section 7](#).

6.1.1 The protective devices shall be compatible with the mode of operation of the motors and shall provide reliable protection against thermal overload.

6.1.2 If the current/time characteristic of the over-load protection device does not correspond to the starting conditions of a motor, provision may be made to suppress operation of the device during the startup period. The short-circuit protection shall remain operative.

**6.2** The switchgear of motors whose simultaneous restarting on restoration of the supply voltage might endanger operation shall be provided with under-voltage protection which prevents automatic restart.

**6.3** Where necessary, the start-up of motors which are required to restart automatically following restoration of the voltage is to be staggered in such a way that the starting currents do not overload the ship's mains.

## **7. Control circuits**

**7.1** The control circuits of essential systems shall be independent of other control circuits.

**7.2** Common control circuits for groups of consumers are permitted only when this is required by functional relationships.

**7.3** For emergency shutdowns, see [Section 4.1.8](#).

**7.4** Control-power transformers shall be protected against short-circuit and overload. Fuses may be used on the secondary side as overload protection. Where the rated current on the secondary side is less than 2 A, the overload protection may be omitted.

**7.5** Switching elements shall not be located in the earthed part (N) of an earthed control circuit.

## **8. Measuring and signalling circuits**

Current loops for signalling and measuring equipment and also indication lamps shall be protected against short-circuit and overload in each non-earthed conductor.

Excepted are indicating lamps with operating voltage  $\leq 24$  V or if measures are taken to prevent influence on control and power circuits in case of short-circuit.

## **9. Exciter circuits**

Exciter circuits and similar circuits whose failure could endanger operation may be protected only against short-circuit.

## **10. Monitoring of insulation resistance**

Each non-earthed primary or secondary system serving power, heating or lighting installations shall be fitted with an equipment which monitors the insulation resistance relative to the ship's hull and gives an optical and audible alarm if the insulation resistance value is abnormally low (see also [Section 20.E](#)).

For tankers, see [Section 15](#).

Insulation monitoring devices may be dispensed with in the case of secondary systems such as control circuits.

## **11. Testing of protection devices for generators and large consumers on board**

Electronic or computerized protection devices for generators and large consumers shall be so designed that the function of the protection equipment can be tested on board, see [Section 10](#).

Especially attention to:

- arrangements to readily identification of the last final settings, in the event of possible change
- facilities and instructions for testing the settings and functions on board

## F. Conductors and Busbar Carriers

### 1. Busbars, bare or painted

#### 1.1 General

1.1.1 Busbars shall be made of copper or copper-plated aluminium, or corrosion-resistant aluminium.

1.1.2 The dimensions of main busbars and section busbars made of copper shall conform to Table 5.1 as a function of their permitted load.

The temperature rise shall not exceed 45 K and shall not have any harmful effect on adjacent components.

1.1.3 Parallel-run busbars of the same phase are to be installed not less than one bar thickness apart. Earth conductors, neutral conductors of three-phase mains and equalization lines between compound-wound generators shall have at least half the cross-section of the phase conductor.

#### 1.2 Connections to equipment

Cross-sections of connection bars and wires to equipment shall be of such size as to avoid thermal over-loading of the equipment at full load as well as in the event of a short-circuit.

### 2. Busbar carriers

Busbars are to be mounted in such a way that they withstand the stresses caused by short-circuit currents and maintain the required clearance and creepage distances relative to other voltage-carrying or earthed components.

**Table 5.1: Permissible loading of copper main busbars and section busbars of rectangular cross-section at 45 °C ambient temperature (45 K temperature rise)**

Width x Thickness [mm]	Maximum permissible loading [A] with 50/60 Hz							
	painted (matt-black)				bare			
	Number of bars				Number of bars			
	1 	2 	3 	4 	1 	2 	3 	4 
15 x 3	230	390	470	-	200	350	445	-
20 x 3	290	485	560	-	250	430	535	-
20 x 5	395	690	900	-	340	620	855	-
20 x 10	615	1145	1635	-	530	1020	1460	-
25 x 3	355	580	650	-	300	510	615	-
25 x 5	475	820	1040	-	405	725	985	-
30 x 3	415	670	735	-	350	590	700	-
30 x 5	555	940	1170	-	470	830	1110	-
30 x 10	835	1485	2070	-	710	1310	1835	-
40 x 5	710	1180	1410	-	595	1035	1350	-
40 x 10	1050	1820	2480	3195	885	1600	2195	2825
50 x 5	860	1410	1645	2490	720	1230	1560	2380
50 x 10	1260	2130	2875	3655	1055	1870	2530	3220
60 x 5	1020	1645	1870	2860	850	1425	1785	2740
60 x 10	1460	2430	3235	4075	1220	2130	2850	3595
80 x 5	1320	2080	2265	3505	1095	1795	2170	3370
80 x 10	1860	2985	3930	4870	1535	2615	3460	4275
100 x 10	2240	3530	4610	5615	1845	3075	4040	4935
120 x 10	2615	4060	5290	6360	2155	3545	4635	5580
160 x 10	3348	5121	6646	7836	2752	4451	5803	6857
200 x 10	4079	6162	7973	9287	3335	5344	6956	8109

**Note:**

The maximum permissible loading applies to switchboards not closed at the rear. In the case of fully enclosed switchboards adequate ventilation is to be ensured, or the loading values stated are to be reduced.

### 3. Clearance and creepage distances

3.1 The values indicated in Table 5.2 apply to main busbars and the associated non-fused connection bars for main, emergency and control switchboards.

3.2 Lower values than those indicated in Table 5.2 may be approved by BKI if the following conditions are met:

- switchgear of standard design
- QM-system approved by BKI
- reduction of pollution by appropriate installation and degree of protection
- type-tested switchboard system

### 4. Insulated wires

4.1 Insulated wires shall be of the stranded type and shall satisfy the requirements for cables and wires set out in Section 12. The cross-section of the conductor shall be at least sufficient for the rated current of the connected equipment. Conductors are to be selected in accordance with Table 5.3.

4.2 Non-fused conductors leading from the main busbar to fuses and circuit breakers shall be as short as possible, but not longer than 1 metre.

Table 5.2: Clearance and creepage distances

Rated service voltage [V](AC/DC)			Minimum clearance [mm]	Minimum creepage distance [mm]
	≤	125	10	12
>125	≤	250	15	20
>250	≤	690	20	25
	>	690	25	35

Table 5.3: Current rating of wire in switchgear

Nominal cross-section of conductor -total cross-section in the case of conductors connected in parallel  [mm <sup>2</sup> ]	Bunched, exposed or in conduits		Wires run singly, at least one conductor diameter apart  Circuits of all kind  Current [A]
	Several powers circuit together	One power circuit together with its associated measuring and control wires	
	Current [A]	Current [A]	
1	9	12	15
1,5	12	15	19
2,5	16	20	25
4	20	27	34
6	26	35	42
10	36	48	58
16	48	65	78
25	66	86	102
35	82	107	125
50	104	133	157

**Table 5.3: Current rating of wire in switchgear (continued)**

Nominal cross-section of conductor -total cross-section in the case of conductors connected in parallel  [mm <sup>2</sup> ]	Bunched, exposed or in conduits		Wires run singly, at least one conductor diameter apart  Circuits of all kind  Current [A]
	Several powers circuit together  Current [A]	One power circuit together with its associated measuring and control wires  Current [A]	
70	130	164	194
95	157	198	231
120	186	231	272

**Note**  
 The current ratings shown applies to conductors with a maximum permissible operating temperature [T] on the conductor of 70 °C and an ambient temperature of 45 °C. For conductors with a maximum permissible operating temperature [T] deviating from 70 °C, the current rating is to be determined by applying the correction factor [F].

T	60 °C	65 °C	70 °C	75 °C	80 °C	85 °C
F	0,77	0,89	1	1,1	1,18	1,26

**4.2.1** These wires shall not be run and mounted together with other wires.

**4.2.2** Control wires for essential equipment shall be so run and protected that they may not be damaged by short-circuit arcs.

**G. Measuring Instruments and Instrument Transformers**

**1. Measuring instruments**

**1.1** The measuring error of switchboard instruments shall not exceed 1,5 % of the full-scale value. Instruments with directional response are to be used for DC generators and batteries.

**1.2** Voltmeters shall have a scale range of at least 120 % of the rated voltage, and ammeters a scale range of at least 130 % of the maximum anticipated continuous-service current. Ammeters are to be so rated that they are not damaged by motor starting currents

**1.3** The scale range of power meters shall be at least 120 % of the rated power. For generators connected in parallel, the scale range shall also register at least 15 % reverse power. Where power meters have only a single current path, all generators shall be measured in the same phase. If the total value of all consumers connected to a single phase exceeds 10 % of the power of the smallest generator, the power meters shall be equipped with multiple movements in order to record the unbalanced load on the outer conductors.

**1.4** Frequency meters shall be capable of registering deviations of ± 5 Hz from the rated frequency.

**2. Instrument transformers**

**2.1** Instrument transformers shall conform to class 1 as a minimum requirement.

**2.2** Current transformers for protective devices shall not exhibit a current error of more than 10 % in the expected overcurrent range.

**H. Testing of Switchboards and Switchgear**

**1. Type-approvals**

The following devices and components are subject to mandatory type approval:



- circuit breakers, load-switches, disconnect-switches and fuses for direct connection to the main busbars and to non-fused, multi-terminal busbars of main, emergency and control switchboards
- generator protection devices
- standardized switchgear in series manufacture with reduced clearance and creepage distances (see [F.3.2](#))

## 2. Tests in manufacturer's works

2.1 All switchboards are to be tested in the manufacturer's works.

2.2 The following are subject to testing in the presence of the Surveyor:

- main switchboards
- emergency switchboards
- distribution switchboards with connected power  $\geq 500$  kW
- all switchboards for cargo-refrigeration systems covered by Class Notation **RIC**
- switchboards for electrical propulsion plants
- starters and controls for steam boiler and thermal oil systems

BKI reserves the right to stipulate a factory test for other switchboards.

### 2.3 Scope of tests

#### 2.3.1 Visual inspection

Checking of manufacture against the approved drawings. The components and materials used shall conform to the Rules.

#### 2.3.2 Functional test

Testing of functional performance on the basis of a test schedule and the approved drawings, as far as is feasible.

#### 2.3.3 High-voltage test

The test voltage specified in [Table 5.4](#) and [Table 5.5](#) is to be applied between the conductors, and between the conductors and the switchboard frame. The duration of the test is 1 minute in each case.

Measuring instruments and other auxiliary apparatus may be disconnected during test.

- Test voltage for main circuits
- For main circuits, the test has to be carried out with the values according to [Table 5.4](#).
- Test voltage for auxiliary circuits
- For auxiliary circuits, the test has to be carried out with the values according to [Table 5.5](#).
- Test voltage for type-approved switchgear
- For the verification of dielectric property of type-approved switchgear the test voltage for routine tests may be reduced to 85 % of the values according to [Table 5.4](#) and [Table 5.5](#).

Table 5.4: Test voltage for main circuits

Rated insulation voltage $U_i$ DC and AC [V]		Test voltage (AC)(r.m.s) [V]
	$U_i \leq 60$	1000
60	$< U_i \leq 300$	2000
300	$< U_i \leq 690$	2500
690	$< U_i \leq 800$	3000
800	$< U_i \leq 1000$	3500
1000	$< U_i \leq 1500^1$	3500

<sup>1</sup>Only for DC voltage

Table 5.5: Test voltage for auxiliary circuits

Rated insulation voltage $U_i$ DC and AC [V]		Test voltage (AC)(r.m.s) [V]
	$U_i \leq 12$	250
12	$< U_i \leq 60$	500
	$U_i > 60$	$2 U_i + 1000$ , but at least 1500

### 2.3.4 Insulation resistance measurement

The voltage test is to be followed by measurement of the resistance of insulation. The insulation resistance measurement is to be performed at a DC voltage of at least 500 V.

In large installations, the switchboard may be divided into a number of test sections for this purpose. The insulation resistance of each section shall be at least 1 MΩ.

## Section 6 Power Electronics

A.	General . . . . .	6-1
B.	Construction . . . . .	6-1
C.	Rating and Design . . . . .	6-1
D.	Cooling . . . . .	6-2
E.	Control and Monitoring . . . . .	6-2
F.	Protection Equipment . . . . .	6-3
G.	Tests . . . . .	6-3

### A. General

For power electronics in electrical propulsion plants, see [Section 13](#).

### B. Construction

1. The Rules set out in [Section 5](#) are to be observed, wherever applicable.
2. Each power-electronics system shall be provided with separate means for disconnection from the mains.

In the case of consumers up to a nominal current of 315 A the combination fuse-contactor may be used. In all other cases, a circuit breaker shall be provided on the mains side.

3. Equipment shall be readily accessible for purposes of measurement and repair. Devices such as simulator circuits, test sockets, indicating lights, etc. are to be provided for functional supervision and fault location.
4. Control-and alarm electronics shall be galvanically separated from power circuits.
5. External pulse cables are to be laid twisted in pairs and screened and kept as short as possible.

### C. Rating and Design

1. Mains reactions of power electronics facilities shall be taken into consideration in the planning of the overall installation, see [Section 1.F.](#) and [K.](#)
2. Rectifier systems shall guarantee secure operation even under the maximum permissible voltage and frequency fluctuations, see [Section 1.F.](#) In the event of unacceptably large frequency and/or voltage variations in the supply voltage, the system shall shut-off or remain in a safe operating condition.
3. For the supply of mains, number and rating of electronic facilities is to be so scaled that in the event of failure of any one power-electronics facility the remainder of the installation is sufficient to:
  - feed all essential equipment which may be in simultaneous operation with the propulsion plant at full power
  - start the biggest consumer without exceeding the maximum permissible voltage and frequency variations.

To maintain the required availability, bypass switching may be resorted to.

4. The semiconductor rectifiers and the associated fuses shall be so selected that their load current is at least 10 % less than the limit current determined in accordance with the coolant temperature, the load and the mode of operation.
5. The permissible periodic peak blocking voltage of the individual component shall be greater by a factor of at least 1,8 than the peak value of the undistorted supply voltage. This value may be reduced for static converter circuits with separate power supplies.
6. Electrical charges in power electronic modules shall drop to a voltage of less than 50 V in a period of less than 5 seconds after disconnection from the mains supply. Should longer periods be required for discharge, a warning label is to be affixed to the appliance.
7. If the replacement of plug-in printed circuit boards while the unit is in operation can cause the destruction of components or the uncontrolled behaviour of drives, a caution label shall be notifying to this effect.
8. The absence of external control signals, e.g. due to a circuit break, shall not cause a dangerous situation.
9. Control-circuit supplies are to be safeguarded against unintended disconnection, if this could endanger or damage the plant.
10. It is necessary to ensure that, as far as possible, faults do not cause damage in the rest of the system, or in other static converters.

**10.1** Special attention shall be paid to the following points:

- mutual interference of static converters connected to the same busbar system
- calculation of commutating impedances reacting to voltage distortion and reacting to other consumers
- the selection of the ratio between the sub transient reactance of the system and the commutating reactance of the static converter
- consideration of reactions from rectifier installations on the commutation of DC machines
- consideration of voltage drops in the ship's mains due to inverter operation
- influence by harmonics and high-frequency interference
- influence on the ship's mains by energy feeding back

**10.2** Where filter circuits and capacitors are used for reactive current compensation, attention is to be paid to the following:

- reaction on the mean and peak value of the system voltage in case of frequency fluctuations
- inadmissible effects on the voltage regulation of generators

## **D. Cooling**

1. Natural cooling is preferred.
2. The safety in operation shall be proved for liquid cooling and forced cooling.
3. An impairment of cooling shall not result in unacceptable overtemperatures, an overtemperature alarm shall be provided.

## **E. Control and Monitoring**

1. Control, adjustment and monitoring shall ensure that the permissible operating values of the facilities are not exceeded.

2. The power supply to all control circuits shall be monitored for voltage failure.
3. For the monitoring of individual modules and assemblies of essential equipment, components shall be provided which in the event of a fault facilitate its recognition.
4. The control shall be so engineered that the installation is protected from damage during the switching-on and switching-off sequence, dedication alterations and faulty operation.

## F. Protection Equipment

1. Power electronic equipment shall be protected against exceeding of their current and voltage limits.

For protective devices, it shall be ensured that upon actuating

- the output will be reduced, or defective part-systems will be selectively disconnected
  - drives will be stopped under control
  - the energy stored in components and in the load circuit cannot have a damaging effect, when switching off.
2. In equipment with a current rating of more than 100 A, each bridge arm or parallel-connected valve shall have a special semiconductor fuse. Exceptions are quenching circuits in self-regulating systems and converters operated with a load-independent current. For all other equipment, fuses on the input/output side may also be used.
  3. Special semiconductor fuses shall be monitored. After tripping the equipment has to be switched off, if this is necessary for the prevention of damage.

Activating of a safety device shall trigger an alarm.

4. Equipment without fuses is permissible if a short-circuit will not lead to the destruction of the semiconductor components.

## G. Tests

### 1. General

1.1 Power electronics assemblies shall be individually tested at the maker's works. A Works Test Report shall be rendered on the tests carried out. Essential equipment from 50 kW/kVA upwards shall be tested in the presence of the Surveyor.

1.2 It is assumed that the requirements of environmental conditions as defined in [Section 1.E.](#) and for electromagnetic compatibility as defined in [Section 1.K.](#) are fulfilled. BKI is entitled to request proof of the relevant parameters, if applicable.

### 2. Extent of routine tests

#### 2.1 Voltage test

Prior to the start of the functional tests a high-voltage test shall be carried out. The RMS value of the alternating test voltage is:

$$U = 2U_n + 1000 \text{ V, duration 1 minute}$$

but at least 2000 V, where  $U_n$  is the maximum nominal voltage between any two points on the power electronics device.

For this purpose, switchgear in power circuits shall be bridged, and the input and output terminals of the power electronics devices and the electrodes of the rectifiers shall be electrically connected with each other. The test voltage shall be applied between the input/output terminals or between the electrodes and:

- the cabinet
- the mains connection side, if the power electronics device is electrically isolated from the mains

## **2.2 Test of insulation resistance**

Following the voltage test, the insulation resistance shall be measured at the same connections as for the voltage test. The measurement shall be performed at a voltage of at least 500 V DC.

## **2.3 Operational test**

The function shall be demonstrated as far as possible.

## **2.4 Testing of protection and monitoring devices**

The response thresholds and the coordinated operation of the protective and monitoring devices shall be demonstrated.

## Section 7 Power Equipment

A.	Steering Gear . . . . .	7-1
B.	Lateral Thrust Propellers and Manoeuvring Aids . . . . .	7-7
C.	Variable Pitch Propellers for Main Propulsion Systems . . . . .	7-8
D.	Auxiliary Machinery and Systems . . . . .	7-8
E.	Deck Machinery . . . . .	7-10
F.	Electrical Heating Equipment and Heaters . . . . .	7-11
G.	Heel-Compensating Systems . . . . .	7-12
H.	Cross-flooding Arrangements . . . . .	7-12

### A. Steering Gear

#### 1. General

1.1 Every ship shall be provided with two as far as possible independent steering gear systems, as follows:

- one main and one auxiliary steering gear
- on every tanker, chemical tanker or gas carrier of 10.000 GT and upwards and in every other ship of 70.000 GT with one main steering gear with two or more identical power units
- on every passenger ship with two main steering gears

Where electrical or electro-hydraulic steering gear is installed, the following Rules are to be observed.

1.2 The design of main and auxiliary steering gears shall conform to SOLAS, Chapter. II-1, Part C, Reg. 29 and 30, and [Rules for Machinery Installations \(Pt.1, Vol.III\) Sec.14.A.](#)

1.3 The electrical systems of main and auxiliary steering gears shall be so designed that a failure in one of them shall not affect the operation of the other. This also applies when the main steering gear comprises two or more identical power units, and an auxiliary steering gear need not therefore be provided under the SOLAS regulations.

1.4 On every tanker, chemical tanker or gas carrier greater than 10.000 GT the main steering gear system shall be so arranged that in the event of loss of steering capability due to a single failure in any part of the power actuating systems of the main steering gear, excluding the tiller, quadrant or components serving the same purpose, or seizure of the rudder actuators, steering capability shall be regained in not more than 45 seconds after the loss of one power actuating system. The isolation of the defect part of the system shall be done by automatic means.

1.5 For increased vibration loads in the steering gear compartment, see [Section 1.E.](#)

#### 2. Power supply

2.1 The power supply to steering gears is also required to comply with the provisions of [Section 4.I](#)

2.2 A separate power supply circuit from the main switchboard is to be provided for each steering gear power unit.

After an electrical power failure, the steering gear power units shall restart automatically when the power is restored.

**2.3** On ships with a calculated rudderstock of more than 230 mm in diameter (see [Rules for Machinery Installations \(Pt.1, Vol.III\) Sec.14.A.4.1](#)), without ice strengthening, an alternative power source additional to the main power source is required, which is capable of supplying the steering gear in such a way that this is able to perform at least the duties of an auxiliary steering gear. It shall also supply the steering gear control system, the remote control of the power unit and the rudder-angle indicator. In addition, the alternative power source shall be automatically connected within 45 seconds after a power failure. This power source may be the emergency generator set, or an independent power source intended only for this purpose and situated in the steering gear compartment, and shall maintain operation:

- for 10 minutes on ships of up to 10.000 GT and
- for 30 minutes on ships of 10.000 GT and over.

**2.4** The system is to be so designed that it is possible, from the bridge or the steering gear compartment, to put each power unit into operation. Mechanically separated switches are to be provided for this purpose.

The supply of the bridge remote control for the power units shall be run from the associated switchgear in the steering gear compartment same as steering gear control system and shall be made for its disconnection without any accessories.

For supplies to the steering gear control systems, see [6](#).

### **3. Design of the electric drives**

**3.1** To determine the torque characteristics required for electric motors of power units, account is to be taken of the breakaway torque and the effective maximum torque of the steering gear under all operating conditions (see [Rules for Machinery Installations \(Pt.1, Vol.III\) Sec.14.A.4.](#)).

**3.2** The following requirements apply to the modes of operation:

**3.2.1** Steering gear with intermittent power demand:

- S 6 - 25 % for converters and the motors of electro-hydraulic drives
- S 3 - 40 % for the motors of electromechanical steering gears

The ratio of pull-out torque to rated torque is to be at least 1,6 in all cases.

**3.2.2** Steering gear with constant power demand:

- S 1 - 100 % continuous service

**3.3** For the motor design, see [Section 20](#).

### **4. Switchgear**

**4.1** Each steering gear motor shall have its own separate switchgear. Combined contactor cabinets are not permitted.

Each steering gear motor shall have an ammeter mounted in the main or emergency switchboard, as applicable, or in the contactor cabinets.

**4.2** The remote-control systems of the power units and the rudder control shall be capable of being disconnected or isolated inside the contactor cabinets (e.g. by removal of the fuse-links or switching off the automatic circuit breakers). These switches or fuses are to be specially marked.

### **5. Protection equipment**

**5.1** The circuits for the control systems and motors of steering gears are to be protected only against short-circuits.



**5.2** Where fuses are used, their current ratings shall be two steps higher than the rated current of the motors. However, in the case of intermittent-service motors, the fuse rating shall not exceed 160 % of the rated motor current.

**5.3** Protection equipment against excess current, including starting current, if provided, is to be required to be not for less than twice the rated current of the motor so protected. Steering gear motor circuits obtaining their power supply via an electronic converter and which are limited to full load current are exempt from above requirement.

**5.4** The instantaneous short-circuit trip of circuit breakers shall be set to a value not greater than 15 times the rated current of the drive motor.

**5.5** The protection of control circuits shall correspond to at least twice the maximum rated current of the circuit, though not, if possible, see 6.

## **6. Steering gear control systems**

**6.1** Ships with electrically operated steering gear controls shall have two independent steering gear control systems. Separated cables and wires shall be provided for these control systems. Where physical separation is not practicable, separation may be achieved by means of a fire-retardant plate.

A common steering wheel or a common tiller may be used.

Steering gear control system covers the equipment required to control the steering gear power actuating system as defined in [Rules for Machinery Installations \(Pt.1, Vol.III\) Section 14.A Table 14.1](#)

**6.2** If a sequential (follow-up) control system and a time control system are provided, each of these systems shall be able to operate on each power unit. Switching of the control systems shall be possible on the bridge.

Where two identical control systems are installed, each control system can be permanently assigned to a power unit.

If a follow-up control system is installed on the bridge wing, then the follow-up tiller shall be fitted with a retaining spring to midship position, or a take-over system/button shall be installed on bridge wings.

**6.3** Provision shall be made for operating the main and auxiliary steering gear from the bridge and the steering gear compartment.

**6.4** The power supplies to the electrical steering gear control systems shall be taken from the power unit supplies in the steering gear compartment or from the corresponding power unit feeders in the main or emergency switchboard (see 2.4).

**6.5** The electrical separation from each other of the steering gear control systems shall not be impaired by the addition of extra systems, such as autopilot systems.

**6.6** For switching over between different control systems a common control selector switch may be provided. The circuits of the various control systems shall be arranged electrically and physically separated.

**6.7** On ships where an automatic control system like heading or track control system is installed, an override facility shall be installed close to the operator unit of the automatic steering system. The Override facility shall be so designed that self-induced return to automatic control is not possible except where the course preselection of the automatic system is automatically kept in line. The switch-over from automatic to manual control by "Override" is to be indicated optically and audibly at the steering position. The override facility shall be independent of the automatic control system or follow-up control mode.

**6.8** Different steering modes including steering gear control positions on the bridge wings shall be changed over by all poles, when it cannot be verified that it is free of reactive effects. Portable steering consoles are to be connected via plugs with pin coding. It is necessary to ensure that the rudder-angle indicator can be read within the range of operation of the portable steering console.

6.9 Repeaters and limit switches if provided shall be linked electrically and mechanically to the respective control system and mounted separately to the rudder stock or the adjusting devices.

6.10 In the case of double follow-up control (see example at Fig. 7.1), the amplifiers shall be designed and fed so as to be electrically and mechanically separated. In the case of non-follow-up control and followup control, it shall be ensured that the follow-up amplifiers are protected selectively (see example at Fig. 7.2).

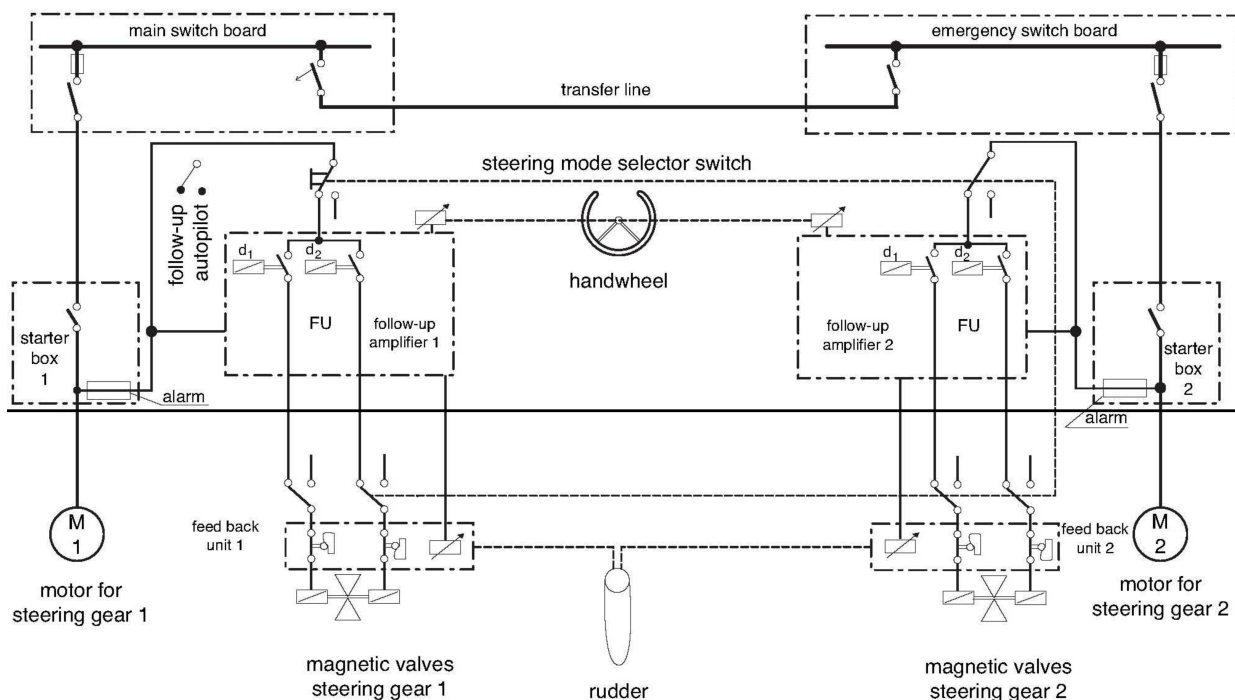

Figure 7.1: Example of principle scheme for double follow-up control

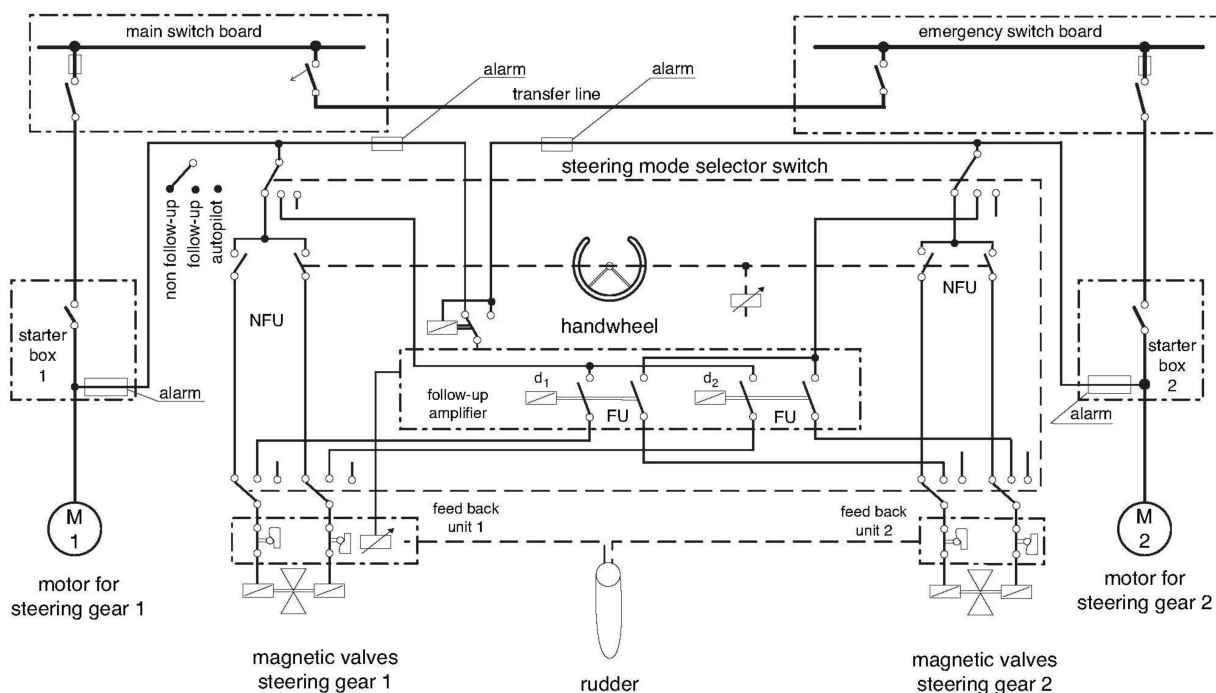

Figure 7.2: Example of principle scheme for double non-follow-up control and follow up control

**6.11** Hydraulic system components in the power actuating or hydraulic servo systems controlling the power systems of the steering gear (e.g. solenoid valves, magnetic valves) are to be considered as part of the steering gear control system and shall be duplicated and separated.

Hydraulic system components in the steering gear control system that are part of a power unit may be regarded as being duplicated and separated when there are two or more separate power units provided and the piping to each power unit can be isolated.

### **6.12 Failure detection**

**6.12.1** The most probable failures that may cause reduced or erroneous system performance shall be automatically detected and at least the following failure scenarios shall be considered:

- 1) Power supply failure
- 2) Earth fault on AC and DC circuits
- 3) Loop failures in closed loop systems, both command and feedback loops (normally short circuit, broken connections and earth faults)
- 4) Data communication errors
- 5) Programmable system failures (Hardware and software failures)
- 6) Deviation between rudder order and feedback
- 7) Deviation alarm shall be initiated if the rudder's actual position does not reach the set point within acceptable time limits for the closed loop control systems (e.g. follow-up control and autopilot). Deviation alarm may be caused by mechanical, hydraulic or electrical failures.

**6.12.2** All failures detected shall initiate audible and individual visual alarm on the navigation bridge.

### **6.13 System response upon failure**

**6.13.1** The failures (as defined but not limited to those in [6.12.1](#)) likely to cause uncontrolled movements of rudder are to be clearly identified. In the event of detection of such failure, the rudder should stop in the current position without manual intervention. For systems and/or operational modes where midship position is considered to be the least critical condition, this may also be accepted. For mechanical failures such as sticking valves and failure of static components (pipes, cylinders), the system response without manual intervention is not mandatory, and the operator can follow instructions on the signboard in case of such failures, in accordance with [Rules for Machinery Installations \(Pt.1, Vol.III\) Sec14.A Table 14.1](#).

**Note:**

*For hydraulic locking failure, refer also to [Rules for Machinery Installations \(Pt.1, Vol.III\) Sec.14.A.3.9.5 and Sec.14.A.7](#)*

## **7. Alarms and indicators**

**7.1** Alarms and indicators for steering gears and controls are to be gathered at least from [Table 7.1](#).

**7.2** Depending on the rudder characteristic, critical deviations between rudder order and response shall be indicated visually and audibly as actual steering mode failure alarm on the navigating bridge. The following parameters shall be monitored:

- Direction: actual rudder position follows the set value;
- Delay: rudder's actual position reaches set position within defined time limits;
- Accuracy: the end actual position shall correspond to the set value within the design offset tolerances.

7.3 The alarms/indicators listed in [Table 7.1](#) shall be signalled visually and audibly irrespective from the automation equipment.

Alarms and indicators on the bridge shall be announced at a position close to main steering station.

7.4 In case of fixed relation between control system and power unit the alarms No. 2 and No. 5 of [Table 7.1](#) may be grouped.

7.5 The energy supply for the alarms and indicators shall be in accordance with [A.2](#).

**Table 7.1: Alarms and indicators**

No.	Alarms/indicators	Main and auxiliary steering gear	
		Bridge	Engine Room
1	Operation of power unit	×	×
2	Power failure of power unit/control	×	⊗
3	Overload of electric drive or phase failure of supply	×	⊗
4	Low level of hydraulic oil tank	×	⊗
5	Power failure of steering control system	×	⊗
6	Hydraulic lock	×	×
7	Failure actual steering mode	×	×
8	Earth fault on AC and DC circuit	×	×
9	Loop failures in closed loop systems, both command and feedback loops (normally short circuit, broken connections and earth faults)	×	×
10	Data communication error	×	×
11	Programmable system failure (hardware and software failure)	×	×
12	Deviation between rudder order and feedback	×	×
Note × = Single indication, see also <a href="#">7.3</a> ⊗ = Group indication			

## 8. Rudder-angle indicator

See [Section 9.C.4](#).

## 9. Tests

9.1 For the testing of electrical motors, see [Section 20](#).

9.2 The following monitoring devices are subject to mandatory type approval:

- phase-failure relays
- level switches

9.3 Steering gear control systems with all components important for the function are subject to a mandatory type approval, e.g.:

- steering mode selector switch
- follow-up/non-follow-up control devices

## 10. Control of steering propeller systems for main propulsion units

### 10.1 Control of the direction of thrust

The requirements of [6](#). shall be applied in an appropriate manner.

## 10.2 Monitoring and testing

The requirements of 7. and 9. shall be applied in appropriate manner.

## 10.3 Indicator

The effect on the course shall be indicated. The regulations in Section 9.C. Shall be applied in appropriate manner.

## B. Lateral Thrust Propellers and Manoeuvring Aids

These Rules apply to equipment with electrical drive.

### 1. Rating

Manoeuvring aids shall generally be rated for continuous duty. Drives used only for lateral thrust shall be designed at least for short-term duty S 2 - 30 minutes at all speeds.

### 2. Protection equipment

2.1 The equipment shall be protected in such a way that, in the event of an overcurrent, an audible and visual warning is first given on the bridge, followed by an automatic power reduction or disconnection of the system if the overload persists. The audible warning shall be acknowledgeable on the bridge. For plants with automatic current limitation the warning is not required.

2.2 If fuses are used for short-circuit protection, a phase-failure supervision is required to prevent the system to be started if one phase fails.

2.3 It shall be ensured that, if a lateral thrust propeller stalls, the main power supply to the drive is disconnected quickly enough to avoid endangering the selectivity of the system with regard to the generator switchgear.

2.4 Motors for short-term duty shall be monitored for critical winding temperature. An exceeding of temperature limits shall be alarmed. If the maximum permissible temperature is reached the output shall be automatically reduced or the motor shall be switched off.

### 3. Controls, monitors and indicators

3.1 For lateral thrusters, the main steering station on the bridge shall be provided with the following indicators:

- an indicating light showing that the system is ready for operation
- an indicating light signalling an overload (for systems without power control)
- depending on the type of equipment, indicators showing the power steps and the desired direction of motion of the ship

3.2 Indications and alarms in the engine room or engine control room:

Faults which may cause failure or endanger the drive shall be signalled optically and audibly as collective alarms.

An ammeter for the drive motor shall be provided at the main switchboard.

3.3 The direction of movement of the controls of lateral thrust units shall correspond to the desired direction of motion of the ship. Power for the electrical control system shall be taken from the main power supply to the drive.

3.4 There shall be an emergency stop at every control station, which affects the feeder breaker in the main switchboard.

### C. Variable Pitch Propellers for Main Propulsion Systems

1. The design and operation of these systems shall conform to [Rules for Machinery Installations \(Pt.1, Vol.III\) Sec.6](#).
2. Provision shall be made to enable the system to be controlled from the bridge and from the engine room.  
Failure of the control system shall be signalled optically and audibly on the bridge and in the engine room.
3. From the main steering station on the bridge it shall be possible to isolate completely any additional electrical remote-control facilities provided on the open deck (e.g. on bridge-wings).
4. Input and output units and actuating devices shall be type-tested.

### D. Auxiliary Machinery and Systems

#### 1. Fire-extinguishing systems

##### 1.1 Fire pumps

**1.1.1** The power supply to the motors and the fire pump control systems are to be so arranged with regard to the assignment of sources of power, the routing of the power-supply cables and the location of the controls that a fire in any main fire zone cannot render all the fire pumps unserviceable (see [Rules for Machinery Installations \(Pt.1, Vol.III\) Sec.12.E.1.](#)).

**1.1.2** If remote starting is provided for fire pumps, pump controls shall be so designed that in the event of failure of the remote control the local control remains operative. Regarding remote starting of fire pumps on ships with unattended engine room, see [Rules for Automation \(Pt.1, Vol.VII\)](#).

**1.1.3** A bypass shall be provided, if fire pumps have a soft starter.

##### 1.2 Pressure water spraying systems (sprinkler)

For the design of these systems, see also [Rules for Machinery Installations \(Pt.1, Vol.III\) Sec.12.L](#).

**1.2.1** Pressure water spraying systems shall be supplied from the main and from the emergency source of electrical power.

**1.2.2** The design of the fire-alarm system shall be according to the requirements of [Section 9.D](#).

**1.2.3** The switches at the main and emergency switchboards required for the power supply to all units forming part of the alarm and extinguishing systems shall be clearly marked.

##### 1.3 For cable laying, see [Section 12.D.1](#).

#### 2. Fans

**2.1** On cargo ships power-driven fans for accommodation, service spaces, cargo spaces, control stations and machinery rooms shall be capable of being switched off from an easily reachable position as safe from fire as possible and located outside the spaces to be ventilated.

The switches for switching off the machinery space ventilation shall be separated from the switches for switching off the other fans, see [Section 4.1.8](#).

**2.2** It is recommended that one of the engine room fans should be supplied from the emergency source of electrical power to enable the extraction of fire-extinguishing gases, should the need arise. Due to this recommendation the requirements of [Section 5.C.2.6](#) are to be observed.

**2.3** Regarding fans for passenger ships, see [Section 14](#).

### 3. Fuel pumps and separators

Controls shall be provided to enable the electric motors of fuel pumps and fuel and lubricating oil separators to be stopped from outside the spaces concerned, see [Section 4.I.8](#).

### 4. Pumps discharging overboard

The motors of pumps discharging overboard and whose outlets are located in the lifeboat launching area above the light waterline shall be equipped with switches next to the launching station of the lifeboats.

### 5. Turning gear

5.1 See also [Rules for Machinery Installations \(Pt.1, Vol.III\), Sec.1.D.9](#).

5.2 The remote control of electrically driven turning gear shall be so designed that the gear motor stops immediately, if the switch or pushbutton is released.

5.3 A disconnect switch shall also be fitted near the drive unit.

5.4 The turning gear shall be equipped with a device which prevents the diesel engine from being started as long as the turning gear is engaged.

### 6. Electric starting equipment for main and auxiliary engines

#### 6.1 General

6.1.1 Regarding additional requirements for diesel engine starting equipment, see [Rules for Machinery Installations \(Pt.1, Vol.III\) Sec.2.H](#).

6.1.2 The starter batteries shall only be used for starting (and preheating where applicable) and for the monitoring equipment and controller associated with the engine.

Maintaining and monitoring of the charge-condition of the batteries is to be ensured.

#### 6.2 Main engines

If main engines are started electrically, two starter batteries mutually independent are to be provided. They shall be so arranged that they cannot be connected in parallel. Each battery shall be capable of starting the main engine from cold condition.

The total capacity of the starter batteries shall be sufficient for the following number of starting operations to be carried out within 30 minutes without recharging:

- reversible main engines:
  - 12 combined reversal and starting operations
- non-reversible main engines:
  - 6 starting operations

#### 6.3 Auxiliary engines

##### 6.3.1 Main generator sets

If several auxiliary engines are started electrically, at least two mutually independent batteries shall be provided. The use of the main engine starter batteries, if there are any, is permitted.

The capacity of the batteries shall be sufficient for at least three starting operations per engine.

If only one of the auxiliary engines is started electrically, one battery is sufficient.

### 6.3.2 Emergency generator sets

- 1) Each emergency generator set that has to be started automatically shall be equipped with a BKI approved starting device with sufficient power for at least three successive starting operations even at an ambient temperature of 0 °C.

If starting is impossible at this temperature or if lower temperatures are likely to be encountered, heating shall be provided to ensure starting of the generator sets.

Additionally, a second source of energy is to be provided capable of three further starting operations within 30 minutes. This requirement can be cancelled if the set can also be started manually.

- 2) To guarantee availability of the starting devices it is to be ensured that:
  - electrical and hydraulic starter systems are supplied from the emergency switchboard
  - compressed-air starter systems are supplied via a non-return valve from the main and auxiliary compressed-air or by an emergency air compressor supplied with power via the emergency switchboard
  - the starting, charging and energy storage equipment is located in the emergency generator room.
  - This equipment is intended for the operation of emergency generator sets only and shall not be used for other purposes.
- 3) If automatic starting is not a requirement, starting equipment, which ensures safe manual starting is permitted, e.g. by hand-crank, spring-powered starter, manual hydraulic or ignition cartridge starter.
- 4) If a direct start by hand is not possible, starting devices as in 1) and 2) shall be provided, manual initiation of the starting process is acceptable.
- 5) If a second source of starting energy is a mechanical starting facility, an electronical speed governor, associated protection devices and valves shall have a back-up power supply independent of the first source of starting energy. This back-up source shall be monitored.
- 6) If mechanical starting facilities are provided, an electronical speed governor, associated protection devices and valves shall have two independent back-up power supplies. These back-up sources shall be monitored.

### 6.3.3 Emergency fire extinguishing sets

If manual starting by hand crank is not possible, the emergency fire extinguishing set shall be equipped with a BKI approved starting device capable of at least 6 starting operations within 30 minutes, two of them carried out within the first 10 minutes, even at an ambient temperature of 0°C.

## 7. Standby circuits for consumers

7.1 Standby circuits shall be provided for the reciprocal operation of consumers with the same function. Changeover to another unit due to a fault shall be signalled optically and audibly.

7.2 Automatically controlled groups of consumers shall be so structured that a fault in one group does not affect the functioning of other groups.

## E. Deck Machinery

### 1. General

#### 1.1 Type of enclosure

The degree of protection for motors and switchgear shall be selected in accordance with [Section 1, Table 1.10](#).



## 1.2 Emergency shut-down

Lifting gear shall be equipped with an emergency switch which allows to stop the drive immediately, should the control system fail. Brakes shall be released automatically if the power supply fails.

## 1.3 Control equipment

Levers and handwheels for the control of lifting equipment shall return automatically to the zero position when released. Exceptions may be allowed for trawl winches and for special-purpose drives.

## 2. Anchor windlasses and capstans

### 2.1 Rating of motors

Motors shall be rated in accordance with [Rules for Machinery Installations \(Pt.1, Vol.III\) Sec.14.D.4](#) for short-term duty (S 2 - 30 minutes), unless the kind of operation for which the ship is intended imposes more stringent demands.

The motors shall be able to deliver 1,6 times the rated torque for 2 minutes without dangerous overheating.

### 2.2 Overload protection

To prevent excessive overloading of the motors and, as far as possible, the gears, electrical overload protection shall be provided as follows:

- Unless the motor is not protected against over-heating by winding temperature monitoring, a time delayed overcurrent protection shall be provided, which in case of overload causes shut-off of the motor after 2 minutes of operation at 1,5 times the rated torque.
- In addition, an electromagnetic release shall be fitted which is so adjusted that the drive is disconnected when the maximum torque of the anchor windlass is attained. Tripping may be delayed for up to about 3 seconds in the case of three-phase motors. The device shall be connected in such a way that, after tripping, the motor can be restarted only from the zero position.
- The electromagnetic release may be dispensed with if the clutch and transmission gears are made so strong that jamming the windlass does not cause any damage.
- The electromagnetic release is not required in electrohydraulic drives where the maximum torque is limited by a safety valve.

## 3. Cargo winches and cranes

Reference is made to the [Guidelines for Loading Gear on Seagoing Ships and Offshore Installations \(Pt.4, Vol.3\)](#).

## 4. Free fall lifeboat launching equipment

If the secondary launching appliance is not dependent on gravity, stored mechanical power or other manual means, the launching appliance shall be connected both to the ship's main and emergency power supplies. According LSA Code, Chapter VI, 6.1.4.7.

The connection box shall be provided with automatically power change-over and shall be installed close to the launching equipment.

## F. Electrical Heating Equipment and Heaters

### 1. Space heating

1.1 Space heaters shall be designed and mounted in such a way that combustible components are not ignited by the heat generated. They shall not suffer damage due to overheating.

1.2 For reasons of fire protection, particular attention shall be paid to the special instructions regarding the fitting and mounting of each unit.

1.3 For the construction of this equipment, see [Section 20.J.2](#).

## 2. Oil and water heaters

These are subject to the provisions of [Section 20.J](#), and [Rules for Machinery Installations \(Pt.1, Vol.III\) Sec.7.I and 7.II](#).

## G. Heel-Compensating Systems

1. The system shall be centrally controlled and monitored. The following facilities are to be provided:

- indicator showing whether the system is in operation
- optical/audible fault indication
- inclination angle indicator

2. The control console shall be provided with a manual emergency OFF switch for ships which are operated only under supervision.

3. Systems which are also operated without supervision shall be provided with a manual emergency OFF switch and an automatic stop device which shuts-down the system independently of the control when the maximum permitted angle of inclination is reached.

4. Automatic stop devices and control units for heel compensation systems are subject to mandatory type approval.

5. In case of danger for persons by working with stabilizers, a local emergency stop device shall be installed.

## H. Cross-flooding Arrangements

1. Where closing devices are installed in cross-flooding arrangements, they shall be capable to be operated from the bridge or from a central location (see also [Rules for Hull \(Pt.1, Vol.II\) Sec.28.G](#), and [Rules for Machinery Installations \(Pt.1, Vol.III\) Sec.11.P.3.1](#)).

Passenger vessels see [Section 14.C.2.6](#).

2. Controls shall be protected against unintentional use.

3. The position of each closing device shall be indicated on the bridge and at the central operating location.

4. Control and indication of the closing devices shall be realized without computer technique.

## Section 8 Medium Voltage Installations

A.	Scope . . . . .	8-1
B.	General Provisions . . . . .	8-1
C.	Network Design and Protection Equipment . . . . .	8-3
D.	Electrical Equipment . . . . .	8-6
E.	Installation . . . . .	8-11

### A. Scope

The following requirements apply to a.c three-phase networks with rated (phase-to-phase) voltages of > 1 kV and not greater than 17,5 kV, and rated frequencies of 50 Hz or 60 Hz.

### B. General Provisions

#### 1. Reference to other regulations

The general provisions of these Rules also apply, as and where appropriate, to medium-voltage installations, except where more particular requirements are laid down in this Section.

#### 2. Rated mains voltage

The values indicated in [Table 8.1](#) are recommended as standard rated voltages and frequencies.

**Table 8.1: Rated voltages and rated frequencies**

Rated voltage [kV]	Highest voltage for equipment [kV]	Rated frequency [Hz]
3,0 3,3	3,6	50 60
6,0 6,6	7,2	50 60
10,0 11,0	12,0	50 60
15,0 16,5	17,5	50 60

#### 3. Clearances and creepage distances

##### 3.1 Clearances

Clearances (phase-to-phase and phase-to-hull) for switchgear shall not be smaller than indicated in [Table 8.2](#).

Intermediate values for rated voltage can be allowed, provided that the next higher minimum clearance is adopted.

### 3.2 Creepage distances

Creepage distances between live parts, and between live and earthed parts, shall be designed in accordance with IEC 60092-503:2007 for the rated voltage of the system, allowance being made for the type of the insulating material and for transient over-voltages due to switching operations and faults.

**Table 8.2: Minimum clearances for switchgears**

Highest voltage for equipment [kV]	Minimum clearance [mm]
3,6	55
7,2	90
12,0	120
17,5	160

**3.2.1** In the busbar area, creepage distances shall not be less than 25 mm/kV for non-standardized components. The highest voltage for equipment according to IEC 60071-1 as amended shall be used as a basis for the dimensioning.

**3.2.2** Insulators shall conform to IEC 60168 and 60273 as amended.

**3.2.3** The creepage distances at busbar penetrations shall be in compliance with IEC 60137 as amended.

**3.2.4** The minimum creepage distance behind current limiting circuit breakers and fuses shall not be less than 16 mm/kV.

### 4. Degrees of protection

**4.1** Each part of the electrical installation is to be provided with a degree of protection appropriate to the location, as a minimum the requirements of IEC 60092-201:2019 and Table 8.3 are to be complied with, in addition to the provisions of [Section 1, Table 1.9](#).

**Table 8.3: Minimum degrees of protection against foreign bodies and water (as per IEC 60529)**

Equipment \ Location	Switchboards	Electrical machinery		Power Transformers
		Motors, generators	Terminal Boxes	
Locked electrical operational compartments <sup>1</sup>	IP 32	IP 23	IP 44	IP 23
Generally accessible operational compartments (category A machinery spaces) and zones below deck (e.g. passage ways, thruster rooms)	IP 44	IP 44	IP 44	IP 44
Open deck	-	IP 56	IP 56	-

<sup>1</sup> Accessible only to trained specialist personnel. Subject to implementation of appropriate safety measures, lower degrees of protection are possible by agreement with BKI (see [Section 2, F.1.](#) and [G.1.](#)).

### 4.2 Protective measures

**4.2.1** A hazard to persons through electrical shock and accidental arcs shall be avoided independently of the required protection against foreign bodies and water.

**4.2.2** For switchgear installations it shall be proved that an internal arc test according to IEC 62271-200 Annex A had been passed. The criteria 1 to 5 shall be fulfilled, see also [Section 2.G.1.4](#).

**4.2.3** Terminal boxes shall be equipped with a device for the calculated expansion of the accidental arc gases. Evidence shall be given to prove the effectiveness of the chosen design.

## **5. Equipotential bonding**

**5.1** All conductive, but in normal operation dead, components of a medium-voltage installation or equipment shall be provided with an electrically conductive connection to the hull.

**5.2** All metal components in the electrical operational compartments shall be included in the equipotential bonding.

## **6. Earthing**

**6.1** Metal parts shall be earthed if, in the event of a fault, there is a possibility to get in contact with live parts either by direct contact or arcing.

Attention shall be paid to adequate dimensioning of the earthing conductors (e.g. for copper conductors the current density shall not exceed a value of  $150 \text{ A/mm}^2$  in the event of a fault).

Such earthing conductors shall have a minimum cross section of  $16 \text{ mm}^2$ .

**6.2** Metal components that have permanent and electrically conductive connections to the hull need not to be separately earthed. Bolted connections for the fixing of units or components are not considered electrically conductive connections.

## **7. Selectivity**

For essential systems, selectivity is to be ensured independently of the neutral point design.

Evidence shall be given to prove downstream selectivity of the complete grid (low- and medium voltage) under all operating conditions.

This applies to short-circuit, over current, and earth-fault tripping. Other protection equipment, also those not required by BKI, may not interfere with this selectivity concept.

## **8. Isolating and earthing devices**

A sufficient number of isolating links and earthing and short-circuit devices shall be provided to enable maintenance work to be performed safely on plant sections.

## **9. Control of Generator and Bus Tie Circuit Breakers**

A single-fault event in the synchronization circuit or in the black-out monitoring shall not lead to an asynchronous connection

## **C. Network Design and Protection Equipment**

### **1. Electrical power supply systems**

**1.1** Essentially, the following arrangements are permitted:

- 3 conductors, insulated from the hull
- 3 conductors with earthed star point

### Note

Tankers are subject to SOLAS, Chapter II-1, Regulation 5.4.1:

*Earthed distribution systems shall not be used in tankers. Exceptionally, the direct earthing of the neutral may be approved for three-phase power networks with (phase-to-phase) voltages of 3000 V and over on a tanker, provided that the value of the neutral point impedance limits the earth-fault current to three times the capacitive phase-charging current of the network. If the phase-charging current is capable of exceeding 10 A, automatic trips are to be provided, which isolate the faulty circuit.*

1.2 Medium-voltage systems are permitted only for fixed installed electrical equipment.

### 1.3 Network configuration for continuity of ship services

It is to be possible to split the main switchboard into at least two independent sections, by means of at least one circuit breaker or other suitable disconnecting devices, each supplied by at least one generator. If two separate switchboards are provided and interconnected with cables, a circuit breaker is to be provided at each end of the cable.

Services which are duplicated are to be divided between the sections.

## 2. Systems with earthed star point

2.1 The neutral point connection shall incorporate a resistance or other current-limiting device, so that in case of a fault the earth-fault current is limited to the full-load current of the largest generator connected to the switchboard. However, the earth-fault current shall not be less than three times the minimum threshold current of the earth-fault monitor.

2.1.1 In order to fulfil the selectivity requirement of B.7, measures shall be taken for installations with current-limited neutral earths to ensure selective disconnection of outputs in which an earth fault has occurred.

2.1.2 Electrical equipment shall be designed to withstand a single pole short-circuit current up to the activation of the protective device.

2.2 Highly resistive earthed mains, which outputs will not be isolated in case of an earth fault, are permitted, if the insulation of the equipment is designed according to 3.2.

2.3 Directly earthed mains without current-limiting device require the prior approval of BKI.

2.4 Isolating links in the neutral point earthing

For each neutral point, isolating links are to be provided for the purposes of maintenance and measurement.

### 2.5 Design of the neutral point connection

2.5.1 All earth resistors shall be connected to the hull.

To prevent possible interference on electronic systems, it is recommended that the individual earth resistors should be conductively linked by cables on the earth side.

2.5.2 Generators for parallel operation may have a common hull connection for the neutral point.

For each dividable busbar section directly supplied by generators, a separate neutral point connection shall be provided.

2.5.3 Earthing resistors shall be dimensioned for twice of the tripping time and shall be protected against overload and short-circuit.

Short-circuit protection is sufficient if the earthing resistor is dimensioned for continuous duty.

### 3. Systems with isolated neutral point

3.1 Since intermittent earth-faults can cause transient overvoltages in networks with an isolated neutral, endangered equipment shall be fitted with overvoltage protection. For this overvoltages of at least 3,3 times UN shall be considered.

3.2 All insulation (of cables, consumers, transformers, generators etc.) shall be designed for the phase-to-phase voltage, if earth-faults will not be isolated immediately.

### 4. Protection equipment

The provisions of Sections 4 and 5 shall apply, as and where appropriate, to the selection of protection equipment.

#### 4.1 Faults on the generator side of the circuit-breaker

Protective devices are to be provided against phase-to-phase faults in the cables connecting the generators to the main switchboard and against interwinding faults within the generators. The protective device (differential protection) shall trip the generator circuit breaker and to automatically de-excite the generator.

In distribution systems with a neutral earthed, phase to earth faults are also to be treated as above.

#### 4.2 Earth-fault monitoring

Every earth-fault in the system shall be visually and audibly signalled.

In low impedance or direct earthed systems provision is to be made to automatic disconnect the faulty circuits. In high impedance earthed systems, where outgoing feeders will not be isolated in case of an earth fault, the insulation of the equipment is to be designed for the phase to phase voltage.

**Note:**

*Earthing factor is defined as the ratio between the phase to earth voltage of the health phase and the phase to phase voltage. This factor may vary between  $1/\sqrt{3}$  and 1.*

*A system is defined effectively earthed (low impedance) when this factor is lower than 0.8. A system is defined non-effectively earthed (high impedance) when this factor is higher than 0.8.*

#### 4.3 Power transformers

4.3.1 The protective devices of power transformers are subject to the provisions of Section 4.D.

4.3.2 Ship service transformers and transformers supplying the power section of a main propulsion drive shall be fitted with differential protection.

4.3.3 Transformers used for supplying primary essential consumers shall be fitted with winding temperature monitors.

4.3.4 Liquid-cooled transformers shall be fitted with protection against outgassing of the liquid.

4.3.5 The liquid temperature shall be monitored. An alarm shall be actuated before the maximum permissible temperature is attained. When the limit temperature is reached, the transformer shall be disconnected.

4.3.6 The liquid filling level shall be monitored by means of two separate sensors. The monitoring system shall actuate an alarm at the first stage and then cause disconnection at the second, when the filling level falls below the permissible limit.

#### 4.4 Voltage transformers for control and measuring purposes

4.4.1 Voltage transformers shall be protected on the secondary side against short-circuit and overload.

#### 4.5 HVHRC Fuses

The use of HVHRC fuses for overload protection is not permitted. They shall be used for short-circuit protection only.

#### 4.6 Low-voltage networks

Low-voltage networks fed via transformers from a medium-voltage network are to be protected against the over-voltages which may result from an insulation failure between the primary and secondary windings.

### D. Electrical Equipment

#### 1. General

##### 1.1 Standstill heating

All electrical equipment which may occasionally be taken out of service and which are not located in heated and ventilated areas shall be equipped with a standstill heater. This heater should switch on automatically when the equipment is switched off.

##### 1.2 Installation

See [Section 2, G](#).

#### 2. Switchgear

##### 2.1 Construction

Switchgear is to be constructed according to the IEC 62271-200:2011.

Switchgear accessible for authorized persons only shall at least comply with accessibility type "A" of IEC 62271-200:2011; Annex AA; AA 2.2.

In public accessible spaces switchgear of accessibility type "B" shall be used. Besides these measures against unauthorized operation shall be provided.

Installation and location of the switchgear and control gear shall correspond with its internal arc classification and classified sides (F, L and R).

**2.1.1** Medium-voltage switchboards shall have metal clad enclosures which are fully partitioned and closed on all sides in accordance with IEC 62271-200:2011 or of the insulation-enclosed type in accordance with IEC 62271-201:2014.

Switchgear supplying secondary essential or non-essential equipment may be of metal enclosed type.

Incorporated low-voltage compartments for control and monitoring systems shall be separated from the medium-voltage compartments in such a way as to render impossible any contact with parts having a rated supply voltage of more than 1000 V.

##### 2.1.2 Fully partitioned switchboards

All sections of a fully partitioned, air-insulated medium-voltage switchboard shall be partitioned with respect to each other and the surroundings so that they are arc-resistant. Continuous busbar compartments or switch compartments are inadmissible.

Each panel shall be subdivided into at least three arc resistant, partitioned function compartments: the terminal compartment, the switch compartment and the busbar compartment.



**2.1.3 Partly partitioned switchboards** If the main medium-voltage switchboard is subdivided into two independent and autonomous installations, a continuous busbar compartment is permissible, provided that a protection system (arc monitor, busbar differential protection) is installed which detects internal faults and isolates the affected part of the installation within 100 ms, respectively accidental arcing is reliably prevented by design measures (e.g. solid insulated busbar systems).

**2.1.4** Switchboards supplying primary essential consumers shall have the service continuity LSC 2 according to IEC 62271-200:2011.

**2.1.5** Evidence shall be provided that medium-voltage switchboards have passed a type test according to IEC 62271-200:2011. A modification of the construction of a switchboard requires re-testing. The same applies to modifications of the gas exhausting system.

**2.1.6** Where draw out switchgear units are used; the following conditions shall be met:

- Functional testing and maintenance shall be capable of being performed in safety, even when the busbar is live.
- Draw out switchgear units shall be fitted with mechanical interlocking devices effective in the operating and disconnected position. A key interlock is permitted for maintenance purposes.
- Draw out switchgear units are to be locked in place in the operating position.
- The fixed contacts for draw out switchgear units are to be so arranged that, in the withdrawn position, the live contact components are automatically covered, or that complete withdrawal is possible only after a cover has been fitted.
- Shutters are to be clearly marked for incoming and outgoing circuits. This may be achieved with the use of colours or labels.

**2.1.7** Doors which give access to medium voltage are to be interlocked in such a way that they can be opened only after closing the earthing switch.

**2.1.8** It shall be possible to split main medium-voltage switchboards into two sections by means of at least one circuit breaker. This breaker shall be fitted with selective protection. It shall be possible to supply each section from at least one generator.

Duplicated consumers shall be divided up amongst the dividable switchboard sections.

**Note:**

*It is recommended that two different, spatially separated main switchboards, coupled via a transfer line, are used.*

**2.1.9** The partitioning of a gas insulated switch-board supplying primary essential equipment shall correspond with the requirements of an air insulated switchboard. Each gas volume shall be monitored.

A pressure drop shall be alarmed. Measures according to manufacturer's instruction shall be initiated.

## **2.2 Auxiliary systems**

**2.2.1** Where electrical energy and/or mechanical energy is required for the operation of circuit breakers and switches, a means of storing such energy which is designed for at least two ON/OFF switching cycles of all the connected components shall be provided.

In general tripping due to overload, short-circuit or under-voltage shall be independent of any stored electrical energy.

If shunt trip coils are used, the continuity of the tripping circuit has to be monitored. When the wire breakage alarm is activated the switching on shall be interlocked. The power supply has to be monitored.

### 2.2.2 Number of energy sources

For the supply of auxiliary circuits two independent uninterruptible power supplies shall be provided. If one of these uninterruptible power supplies fails, the remaining unit shall supply all switchboard sections. The switch-over to the reserve source of energy shall be automatically and actuate an alarm. One uninterruptible power supply shall be fed from the emergency switchboard, and the other one from the main switchboard.

### 2.3 Tests

A routine test in accordance with IEC 62271-200:2011 shall be performed in the manufacturer's works in the presence of the BKI Surveyor.

A functional test of the interlocking conditions, protective functions, synchronization in the various operating modes shall be performed.

A test schedule shall be compiled and submitted for approval.

**2.3.1** It is recommended that a partial-discharge test be performed in accordance with IEC 62271-200:2011 Annex BB as amended if organic insulating materials or gas-insulated busbar penetrations are used.

#### 2.3.2 High-voltage test

A voltage test at power-frequency shall be performed on every switchgear and control gear assemblies. The test procedure and voltages are to be according to the IEC 62271-200:2011 section 7/ routine test as amended.

### 2.4 Low voltage main switchgear design

**2.4.1** If the low-voltage main switchboard is supplied from the medium-voltage system a circuit breaker for the longitudinal separation of the main busbar shall be provided.

The busbar sections shall be supplied by circuit breakers suitable for isolation.

**2.4.2** The arrangement of supply and consumer sections shall be in accordance with [Section 5.C.2](#).

**2.4.3** The feeder panels of the low-voltage switchboard shall be partitioned with arc-resistant segregations.

**2.4.4** The unsynchronized connection of subnet-works and the feedback on the medium-voltage side shall be prevented by means of interlocking.

**2.4.5** Parallel operation of ship service transformers is only permissible for short-term load transfer, if also the medium voltage sides of the transformers are connected.

A forced splitting, independent of the automation system shall be provided.

**2.4.6** After black-out of the supply of the main switchboard or a partial black-out of bus bar sections in the low voltage main switchgear, the recovery of the power supply shall be performed automatically.

**2.4.7** If the black out of the supply is caused by a short-circuit in the low voltage switchboard no automatic recovery shall be carried out.

**2.4.8** The manual connecting of the stand by supply shall be possible after the acknowledgement of short-circuit trip.

**2.4.9** A stand by alarm shall be triggered, if components, necessary for the automatic recovery, are not available.

**2.4.10** A switching off of the medium voltage circuit breaker shall cause the opening of the low voltage circuit breaker.

**2.4.11** The supply panels shall meet the requirements for generator panels of this Section analogously.

**2.4.12** The low voltage supply panels shall be equipped with a voltmeter and an ampere-meter. It shall be possible to display the currents and voltages of all three phases.

**2.4.13** The operation modes On, Off, Tripped and Ready shall be indicated by signal lights.

### **3. Switchboard equipment**

#### **3.1 General**

Control circuit equipment is subject to the conditions for low-voltage switchgear (see [Section 5](#)).

#### **3.2 Circuit breakers**

It shall be possible to operate the mechanical off of the circuit breaker having the doors closed.

It is to prove that the circuit breaker fulfils the requirements of [Section 20.E.3.1.1 d](#) also when actuating the mechanical on button.

Circuit breakers shall comply with IEC 62271-100 as amended.

**3.2.1** For draw out circuit breakers, see [2.1.5](#).

**3.2.2** Circuit breakers shall be interlocked with the associated earthing switch.

#### **3.3 Load switch-disconnectors and isolating switches**

Load switch-disconnectors and isolating switches shall comply with IEC 62271-102/103 as amended.

**3.3.1** Isolating switches shall be interlocked so that they can only be switched under no load. The use of load-switch-disconnectors is recommended.

**3.3.2** Earthing switches shall have making capacity.

#### **3.4 HVHRC fuses**

HVHRC fuses shall conform to IEC 60282 as amended.

#### **3.5 Power contactors**

Power contactors shall conform to IEC 62271-106 as amended.

Medium voltage power contactor fuse combinations shall be dimensioned according to IEC 62271-106 sub clause 4.107.3 "damage classification, type c".

Is the safety of the staff and the selective protection of the ships grid ensured by connected upstream devices medium voltage contactors supplying secondary or unessential consumers may be dimensioned according to "damage classification type a" of IEC 62271-106 as amended.

#### **3.6 Current and voltage transformers**

**3.6.1** Transformers shall conform to the following IEC publications:

- current transformers, IEC 60044-1 as amended
- voltage transformers, IEC 60044-2 as amended

**3.6.2** Earthing of current-and voltage transformers

The secondary winding of every current-and voltage transformer shall be earthed by means of a copper conductor at least 4 mm<sup>2</sup> in cross-section. Open delta windings shall only be earthed at one point.

### 3.7 Relays

Relays for measuring and protective devices shall conform to IEC 60255 as amended.

## 4. Electrical machines

### 4.1 Design

#### 4.1.1 Generator stator windings

The ends of all stator windings shall be run to terminals in the terminal box.

Generator stator windings are to have all phase ends brought out for the installation of the differential protection.

#### 4.1.2 Winding temperature monitoring

Rotating machinery is to be provided with temperature detectors in their stator windings to actuate a visual and audible alarm in a normally attended position whenever the temperature exceeds the permissible limit.

If embedded temperature detectors are used, means are to be provided to protect the circuit against overvoltage.

### 4.2 Terminal boxes

Terminals with operating voltages above 1000 V shall be provided with their own terminal boxes. Terminals shall be marked clearly, see also [B.4.2.3](#).

### 4.3 Tests

The tests specified in [Section 20. A.](#) apply to medium-voltage machines, as and where appropriate. In addition to the tests normally required for rotating machinery, a high frequency high voltage test in accordance with IEC 60034-15:2009 is to be carried out on the individual coils in order to demonstrate a satisfactory withstand level of the inter-turn insulation to steep fronted switching surges.

## 5. Power transformers

### 5.1 Design

**5.1.1** Liquid cooled transformers shall conform to the applicable part of IEC 60076 series.

**5.1.2** Dry-type transformers should be used by preference. They shall conform to IEC 60076-11:2018. Exceptions shall be agreed with BKI.

**5.1.3** Only transformers with separate windings shall be used. Exceptions are auto-transformer starters.

**5.1.4** Transformers producing a low voltage from a medium voltage shall be equipped with an earthed shielding winding between the low-voltage and medium-voltage coil.

**5.1.5** If liquid-cooled transformers are used, measures shall be taken to ensure that the windings are completely covered by oil, even for inclinations of 22,5°.

### 5.2 Ship service transformers

**5.2.1** If the ship's low-voltage network is supplied from the medium-voltage network, at least two mutual independent ship service transformers shall be installed.

Control and protection shall comply correspondingly with the requirements of [Section 4](#) and [5](#) for the main electrical power supply.

**5.2.2** Ship service transformers shall be equipped with an amperemeter. It shall be possible to display the current of all three phases.

### 5.3 Tests

Power transformers shall be individually tested at the manufacturer's works in the presence of the Surveyor.

5.3.1 The scope of the tests is specified in Section 20. B and in the relevant IEC standards.

5.3.2 The test voltages shall be selected in accordance with, Section 20, Table 20.7.

## 6. Cables

### 6.1 General

6.1.1 Medium-voltage cables shall conform to IEC 60092-354:2020 or 60502 series and 60092-353:2016 or other equivalent Standard.

6.1.2 Medium-voltage cables shall be marked.

6.1.3 The regulations stated in [Section 12](#) apply as and where appropriate.

### 6.2 Selection of cables

6.2.1 The nominal voltage of a cable shall not be less than the nominal operational voltage of the related circuit.

6.2.2 In insulated-neutral networks, the phase-to-phase voltage (U) of the network shall be deemed to be the rated voltage (U<sub>0</sub>) of the cable between one conductor and the ship's hull, see also [C.3.2](#).

### 6.3 Tests

Tests shall be performed in accordance with [Section 20. F.](#), as and where appropriate. The voltages for the high-voltage test are listed in [Table 8.4](#).

## E. Installation

### 1. General

See [Section 2. G](#)

### 2. Cable installation

#### 2.1 Cable routes

In accommodation spaces, high voltage cables are to be run in enclosed metallic cable conduits. In the case of cable layouts not adhering to this rule, approval by BKI is required prior to the start of installation work.

#### 2.2 Separation of cables

2.2.1 Medium voltage cables operating at different voltages are to be segregated from each other; in particular, they are not to be run in the same cable bunch, nor in the same ducts or pipes, or, in the same box.

Where medium voltage cables of different voltage ratings are installed on the same cable tray, the clearance between cables is not to be less than the minimum clearance for the higher voltage side shown in [Table 8.2](#).

2.2.2 Medium voltage cables are not to be installed on the same cable tray for the cables operating at the nominal system voltage of 1 kV and less.

Other means of separation are to be agreed by BKI.

## 2.3 Construction of the installation

**2.3.1** Medium-voltage cables laid in open cable trays shall be provided with continuous metal shields and armoring against mechanical damage; shields and armoring shall be electrically conductive connected to the ship's hull.

**2.3.2** Medium-voltage cables without armoring shall be laid so that they are protected against mechanical damages, e.g. in closed metal ducts which are electrically conductive connected to the ship's hull.

For the installation of single core cables, the metal ducts shall be made of non-magnetic material, unless the cables are installed in triangle formation, See [Figure 8.1](#).

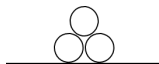

**Figure 8.1: Triangle formation of cable (section view)**

**2.3.3** For bends, the minimum-bending radius permitted by the manufacturer shall be observed; if not specified than the bending radius shall be not smaller than 12 times of the outer diameters of the cable.

## 2.4 Marking of cable ducts and conduits

Cable ducts and conduits for medium-voltage cables shall be marked in accordance with [Section 2.G](#).

## 2.5 Connections

**2.5.1** As far as is feasible, all connections of a medium-voltage cable shall be covered with suitable insulating materials.

**2.5.2** In terminal boxes where the conductors are not insulated, the phases are to be separated from each other and from the hull potential by mechanically robust barriers of suitable insulating material.

High voltage cables of the radial field type, i.e. having a conductive layer to control the electric field within the insulation, are to have terminations which provide electric stress control.

Terminations are to be of a type compatible with the insulation and jacket material of the cable and are to be provided with means to ground all metallic shielding components (i.e. tapes, wires etc).

## 2.6 Sealing end's, joints and kits

**2.6.1** For medium-voltage kits from 3,6/ 6 kV measures shall be taken to attenuate the electrical fields which occur at points where cable insulations are removed (sealing ends).

**2.6.2** The materials of sealing ends and joints shall be compatible to the corresponding cables.

**2.6.3** The construction of joints shall permit the separate through-connection of all shields and armoring.

**2.6.4** Sealing ends shall enable shields and armoring to be brought out.

## 2.7 Processing

The manufacturer's assembly instructions shall be observed.

### 3. Tests

#### 3.1 Tests following installation

When the installation work has been completed, medium-voltage cables are to undergo voltage tests in the presence of the Surveyor; the sealing ends and cable joints shall also be tested.

The test is to conform to IEC 60502 as amended.

**Note:**

*Compliance with the safety regulations for tests at high voltage is the responsibility of the person in charge.*

#### 3.2 The following tests can be applied alternatively:

- high-voltage test at 70 % of the DC voltage test value shown in [Table 8.4](#) for a period of 15 minutes between conductor and shield, or
- test using the rated (phase-to-phase) voltage/ frequency between conductor and shield for a period of 5 minutes, or
- test using the operating voltage of the system for a period of 24 hours

**Table 8.4: Test voltages for medium-voltage cables**

Max. system voltage $U_m$	kV	1,2	3,6	7,2	12	17,5	24,0
Rated voltage $U_o/U$	kV/kV	0,6/1,0	1,8/3,0	3,6/6,0	6,0/10,0	8,7/15,0	12,0/20,0
AC test voltage	kV	3,5	6,5	11,0	15,0	22,0	30,0
DC test voltage	kV	8,4	15,6	26,4	36,0	52,8	72,0
Notes $U_o$ : rated voltage between conductor and earth or metal shield. $U$ : rated voltage between the conductors for which the cable is designed.							

**3.3** The insulation resistance is to be measured before and after the high-voltage test (500 V/ 200 M $\Omega$ ).

**3.4** After completion of the test, the conductors are to be connected to earth for a sufficient period in order to remove any trapped electric charge.

An insulation resistance test is then repeated.

*This page intentionally left blank*



## Section 9 Control, Monitoring and Ship's Safety Systems

A.	General Requirements . . . . .	9-1
B.	Machinery Control and Monitoring Installations . . . . .	9-2
C.	Ship Control Systems . . . . .	9-6
D.	Ship Safety Systems . . . . .	9-9

### A. General Requirements

#### 1. Scope

1.1 This Section sets out requirements for the equipment and design of control, monitoring and ship's safety systems necessary for the operation of the ship and the machinery installation and for the safety of the vessel.

1.2 The general requirements stated in this Section also apply to the open and closed-loop control and measuring systems of essential equipment, see [Section 1](#).

1.3 Regarding additional requirements for ships with unattended engine room, see the [Rules for Automation \(Pt.1, Vol.VII\)](#).

#### 2. Planning and design

2.1 The requirements laid down for each unit and system depending on their use and the process-technological conditions. The Construction Rules stipulate the minimum requirements for these.

2.2 If special operating conditions call for a particular system design, BKI reserve the right to impose additional requirements, depending on the operational and system-specific considerations.

2.3 The design of safety measures, open and closed loop controls and monitoring of equipment shall limit any potential risk in the event of breakdown or defect to a justifiable level of residual risk.

2.4 Where appropriate, the following basic requirements shall be observed:

- compatibility with the environmental and operating conditions
- compliance with accuracy requirements
- recognisability and constancy of the parameter settings, limiting-and actual values
- compatibility of the measuring, open and closed loop controls and monitoring systems with the process and its special requirements
- immunity of system elements to reactive effects in overall system operation
- non-critical behaviour in the event of power failure, restoration and of faults
- unambiguous operation
- maintainability, the ability to recognise faults and test capability
- reproducibility of values

2.5 Automatic interventions shall be provided where damage cannot be avoided by manual intervention.

2.6 If dangers to persons or the safety of the ship arising from normal operation or from faults or mal-functions in machinery or plant, or in control, monitoring and measuring systems, cannot be ruled out, safety devices or safety measures are required.

2.7 If dangers to machinery and systems arising from faults or malfunctions in control, monitoring and measuring systems cannot be ruled out, protective devices or protective measures are required.

2.8 Where mechanical systems or equipment are either completely or partly replaced by electric/electronic equipment, the requirements relating to mechanical systems and equipment according to [Rules for Machinery Installations \(Pt.1, Vol.III\)](#), shall be met accordingly.

### 3. Design and construction

3.1 Machinery alarm systems, protection and safety systems, together with open and closed loop control systems for essential equipment shall be constructed in such a way that faults and malfunctions affect only the directly involved function. This also applies to measuring facilities.

3.2 For machinery and systems which are controlled remotely or automatically, control and monitoring facilities shall be provided to permit manual operation.

3.3 In the event of disturbances automatically switched-off plants shall not be released for restarting until having been manually unlocked.

### 4. Application of computer systems

If computer systems are used, Section 10 has to be observed.

### 5. Maintenance

5.1 Access shall be provided to systems to allow measurements and repairs to be carried out. Facilities such as simulation circuits, test jacks, pilot lamps, etc. are to be provided to allow functional checks to be carried out and faults to be located.

5.2 The operational capability of other systems shall not be impaired as a result of maintenance procedures.

5.3 Where the replacement of circuit boards in equipment which is switched on may result in the failure of components or in the critical condition of systems, a warning sign shall be fitted to indicate the risk.

5.4 Circuit boards and plug-in connections shall be protected against unintentional mixing up. Alternatively, they shall be clearly marked to show where they belong to.

## B. Machinery Control and Monitoring Installations

### 1. Safety devices

1.1 The design of safety devices shall be as simple as possible and shall be reliable and inevitable in operation. Proven safety devices which are not depending on a power source are to be preferred.

1.2 The suitability and function of safety devices shall be demonstrated in the given application.

1.3 Safety devices shall be designed so that potential faults such as, for example, loss of voltage or a broken wire shall not create a hazard to human life, ship or machinery.

These faults and also the tripping of safety devices shall be signalled by an alarm.

1.4 For preference, safety devices shall be designed in conventional technology (hard wired). Alternative technical solutions shall be agreed with BKI.

1.5 The adjustment facilities for safety devices shall be designed so that the last setting can be detected.

1.6 Where auxiliary energy is needed for the function of safety devices, this has to be monitored and a failure has to be alarmed.

1.7 Security equipment like short circuit monitoring of generators as well as over speed monitoring of diesel engines shall run independently from automatic power control system, to ensure that the equipment can continue operating manually in case of a break-down.

1.8 Safety devices are subject to mandatory type approval.

## 2. Safety systems

2.1 Safety systems shall be independent of open and closed loop control and alarm systems. Faults in one system shall not affect other systems.

Deviations from this requirement may be allowed for redundant equipment with the agreement of BKI where this would entail no risk to human life and where ship safety would not be compromised.

2.2 Safety systems shall be assigned to systems which need protection.

2.3 Where safety systems are provided with overriding arrangements, these shall be protected against unintentional operation. The actuation of overriding arrangements shall be indicated and recorded.

2.4 The monitored open-circuit principle shall be used for safety systems. Alternatively, the closedcircuit principle shall be applied where the provisions of national regulations demand it. (e.g. boiler and oilfired systems). Equivalent monitoring principles are permitted.

Faults, and also the tripping of safety systems shall be indicated by an alarm and recorded.

2.5 Safety systems shall be designed for preference using conventional technology (hard wired). Alternative technical solutions shall be agreed with BKI.

2.6 The power supply shall be monitored, and loss of power shall be indicated by an alarm and recorded.

2.7 Safety systems are subject to mandatory type approval.

## 3. Manual emergency stops

3.1 Manual emergency stops are to be protected against unintentional activation.

3.2 The manual emergency stop shall not be automatically cancelled.

3.3 It shall be recognizable which manual emergency stop has been activated.

3.4 Manual emergency stops shall be designed according to the monitored open-circuit principle.

## 4. Open loop control

4.1 Main engines and essential equipment shall be provided with effective means for the control of its operation. All controls for essential equipment shall be independent or so designed that failure of one system does not impair the performance of other systems, see also [A.2.4](#), [B.8](#). and [B.9](#).

4.2 Control equipment shall have built-in protection features where incorrect operation would result in serious damage or in the loss of essential functions.

4.3 The consequences of control commands shall be indicated at the respective control station.

4.4 Controls shall correspond with regard to their position and direction of operation to the system being controlled resp. to the direction of motion of the ship.

4.5 It shall be possible to control the essential equipment at or near to the equipment concerned.

4.6 Where controls are possible from several control stations, the following shall be observed:

- Competitive commands shall be prevented by suitable interlocks. The control station in operation shall be recognizable as such.
- Taking over of command shall only be possible with the authorization of the user of the control station which is in operation.
- Precautions shall be taken to prevent changes to desired values due to a change-over in control station.
- Open loop control for speed and power of internal combustion engines (main and auxiliary engines) and electrical actuators are subject to mandatory type approval.

## 5. Closed loop control

5.1 Closed loop control shall keep the process variables under normal conditions within the specified limits.

5.2 Closed loop controls shall maintain the specified reaction over the full control range. Anticipated variations of the parameters shall be considered during the planning.

5.3 Defects in a control loop shall not impair the function of operationally essential control loops.

5.4 The power supply of operationally essential control loops shall be monitored, and power failure shall be signalled by an alarm.

5.5 Closed loop control for speed and power of internal combustion engines (main and auxiliary engines) and electrical actuators are subject to mandatory type testing.

## 6. Alarm systems

6.1 Alarm systems shall indicate unacceptable deviations from operating figures optically and audibly.

6.2 Alarm delays shall be kept within such time limits that any risk to the monitored system is prevented if the limit value is exceeded.

6.3 Optical signals shall be individually indicated. The meaning of the individual indications shall be clearly identifiable by text or symbols.

If a fault is indicated, the optical signal shall remain visible until the fault has been eliminated. It shall be possible to distinguish between an optical signal which has been acknowledged and one that has not been acknowledged.

6.4 It shall be possible to acknowledge audible signals.

The acknowledgement of an alarm shall not inhibit an alarm which has been generated by new causes.

Alarms shall be discernible under all operating conditions. Where this cannot be achieved, for example due to the noise level, additional optical signals, e.g. flashing lights shall be installed.

6.5 In individual cases, BKI may approve collective alarms from essential, stand-alone systems which are signalled to the machinery alarm system.

6.5.1 Each new single alarm, which will not lead to stop, has to retrigger the collective alarm.

6.5.2 The individual alarms have to be recognisable at the concerned system.

6.6 Transient faults which are self-correcting without intervention shall be memorized and indicated by optical signals which shall only disappear when the alarm has been acknowledged.

6.7 Alarm systems shall be designed according to the closed-circuit principle or the monitored opencircuit principle. Equivalent monitoring principles are permitted.

6.8 The power supply shall be monitored, and a failure shall cause an alarm.

## 7. Operational devices for main and auxiliary engines

Operational devices required for the engine room control position in accordance with the [Rules for Machinery Installations \(Pt.1, Vol.III\) Sec.2.1.2.1](#) and [1.2.2](#) for:

- speed/direction of rotation
- lubricating oil pressure
- control air pressure
- fuel pressure

shall be electrically independent of other systems.

## 8. Reversal alarm system

On ships whose main engines are not remotely controlled from the navigating bridge, the engine telegraph system shall be equipped with a reversal alarm. An audible signal shall sound until the direction of motion demanded by the engine telegraph corresponds with the direction of rotation of the main engine, as indicated by the reversing shaft.

## 9. Speed/output controls of diesel engines

### 9.1 General

**9.1.1** The governor and the actuator shall be suitable for controlling the engine under the operating conditions laid down in the Rules for Construction and shall be also in line with the requirements specified by the engine manufacturer, see [Rules for Machinery Installations \(Pt.1, Vol.III\) Sec.2.F](#).

**9.1.2** Electrical governors and the associated actuators are subject to mandatory type approval.

**9.1.3** In the event of faults in the governor system, the operating condition of the engine shall not become dangerous.

Faults in the governor system shall cause an alarm.

In the case of main propulsion engines, engine speed and power shall not increase.

In the case of auxiliary engines, in the event of faults in the governor system, the fuel admission in the injection pumps shall be set to "0".

### 9.2 Power supply to the control systems of main propulsion engines

**9.2.1** Control systems with an independent back-up system shall be supplied from the main source of electrical power.

**9.2.2** Where main propulsion engines can be operated without a supply of electrical power (pumps driven from the main engine), their control systems (if they have no back-up system) shall be supplied from the main source of electrical power with battery back-up for at least 15 minutes.

The automation battery, if of sufficient capacity, may be used for this purpose.

**9.2.3** Where main propulsion engines can only be operated with a supply of electrical power (electrically driven pumps), their control systems shall be fed from the main source of electrical power.

**9.2.4** Dedicated power supplies shall be provided for each control system of plants comprising a number of main propulsion engines.

**9.2.5** Dedicated power supplies shall be provided for each control system of plants comprising a number of main propulsion engines.

### 9.3 Power supply to the control systems of generator sets

9.3.1 Each control system shall be provided with a separate supply from the main source of electrical power with battery back-up for at least 15 minutes.

9.3.2 If there are more than two auxiliary engines, a total of two back-up batteries is sufficient.

9.3.3 If the auxiliary engines are started electrically, a combination of the back-up battery with the starter battery is permissible.

The automation battery may be used as a second back-up battery to boost the input voltage.

9.3.4 No supply or battery back-up is required for a control system with its own power source.

9.3.5 No battery back-up is needed if a back-up system is provided.

9.3.6 Batteries shall not be discharged by the control system following an engine shutdown.

## 10. Integration of systems for essential equipment

10.1 The integration of functions of independent equipment shall not decrease the reliability of the single equipment.

10.2 A defect in one of the subsystems (individual module, unit or subsystem) of the integrated system shall not affect the function of other subsystems.

10.3 Any failure in the transfer of data of autonomous subsystems which are linked together shall not impair their independent function.

10.4 Essential equipment shall also be capable of being operated independently of integrated systems.

## C. Ship Control Systems

### 1. Remote control of the main engine

Where the remote control of the main engine from the bridge is envisaged, the requirements according to [Rules for Automation \(Pt.1, Vol.III\) Sec.5.A.](#) shall be observed.

### 2. Engine telegraph systems

#### 2.1 General

2.1.1 Two independent means shall be provided for communicating orders from the navigation bridge to the position in the machinery space or in the control room from which main propulsion is normally controlled.

One of these means shall be an engine telegraph, even if the remote control of the engine is foreseen, irrespective of the fact that the engine room is attended or not. A further means according to [2.3](#) or [5.1](#) could be provided.

2.1.2 Engine telegraphs shall be of the two-way systems type in which the signal given by the receiver is also immediately discernible at the transmitter.

2.1.3 In the case of installations with several controls positions the acknowledged command shall be indicated at all control positions. Where control positions are selected by switching, additionally indication shall be provided of which one is in use.

2.1.4 Transmitters and receivers shall be equipped with call-up devices which remain activated from the start of the command transmission until it is correctly acknowledged.

2.1.5 The audible signal shall be hearable at all points in the engine room. If necessary, optical signals shall be provided in addition to the audible signals.

2.1.6 Power supply shall be provided from the main source of electrical power.

## 2.2 Main engine telegraph system

2.2.1 The controls of the transmitters and receivers shall be safeguarded by suitable means (e.g. notching) against inadvertently move.

2.2.2 Engine telegraphs shall be of the two-way systems type in which the signal given by the receiver is also immediately discernible at the transmitter.

2.2.3 In the case of installations with several controls positions the acknowledged command shall be indicated at all control positions. Where control positions are selected by switching, additionally indication shall be provided of which one is in use.

2.2.4 Transmitters and receivers shall be equipped with call-up devices which remain in operation from the start of the command transmission until it is correctly acknowledged. The audible signal shall be hearable at all points in the engine room. If necessary, optical signals shall be provided in addition to the audible signals.

2.2.5 Power supply shall be provided from the main source of electrical power.

## 2.3 Emergency engine telegraph system

2.3.1 The function of the emergency engine telegraph system shall conform to that of the main system in accordance with 2.2.1 and 2.2.2.

Power supply shall be provided from the emergency source of electrical power.

2.3.2 Instead of the emergency engine telegraph system a further means according to 5.1 could be provided.

## 3. Indicators on the bridge

3.1 All instruments and indicators important to the control of the ship shall be legible at all times.

3.2 All indicators and illuminations for instruments shall be provided with dimmers.

3.3 All illumination and lighting of instruments shall be adjustable down to zero, except the lighting of warning and alarm indicators and the control of the dimmers which shall remain readable.

3.4 Each instrument shall be fitted with an individual light adjustment. In addition, groups of instruments normally working together may be equipped with common light adjustment.

## 4. Rudder angle indicators

4.1 The ship's main control station shall be equipped with a rudder angle indicator whose transmitter is actuated by the rudderstock.

4.2 All the equipment forming part of the rudder angle indicator system shall be independent of the steering gear control.

4.3 The rudder angle indicator shall be legible from all control stations on the bridge. The display shall be continuous.

4.4 If the rudder angle is not clearly apparent at the emergency manual steering gear control position in the steering gear compartment, an additional rudder angle indicator shall be fitted.

4.5 The above requirements also apply, as and where appropriate, to rudder propeller systems. The indicators shall be so designed that they indicate the thrust direction of motion of the ship.

4.6 If the steering gear shall be also supplied from the emergency source of electrical power, the rudder angle indicator shall be supplied from the main and emergency source of electrical power (see also [Section 7.A.2.3](#)).

## 5. Communication, voice communication and signalling systems

### 5.1 Important means of communication

5.1.1 The means of communication shall be designed to ensure satisfactory intercommunication under all operating conditions.

5.1.2 The means of communication shall be designed as individual links. Alternatively, a telephone system or an intercommunication system may be used, provided that the bridge can cut into existing communications in any event.

5.1.3 The call-up devices shall be so designed that they are discernible under the respective environmental conditions. Additional optical means may be used for this purpose.

5.1.4 If the means of communication requires an electrical power supply, this supply shall be from the main switchboard and the emergency switchboard. [Section 3.C.3.2.4](#) and [C.3.4.2](#) are to be observed.

### 5.2 Voice communications in an emergency

5.2.1 An appropriate mean of communication shall be provided which enables commands to be transmitted between strategically important locations:

- Between assembly points, the emergency control stations, the muster stations and the launching stations of lifesaving equipment.
- From the navigation bridge and the engine-room to any other position from which the main propulsion plant may be controlled.
- Between the navigation bridge and the steering gear compartment.
- Between the navigation bridge and the radio telegraph or radio telephone stations.

5.2.2 These systems may comprise portable or permanently installed equipment and shall also be operable in the event of a failure of the main power supply.

5.2.3 If portable equipment is provided the number of VHF transceivers shall be at least:

- 2 on cargo ships  $\geq 300$  GT
- 3 on cargo ships  $\geq 500$  GT

### 5.3 Technical officer's alarm (Engineers' call)

From the engine room or from the engine control room it shall be possible to transmit an alarm into the accommodation area of the technical officers or the crew members responsible for the machinery.

For ships with automated machinery, [Rules for Automations \(Pt.1, Vol.VII\) Sec.4](#) is to be observed additionally.

### 5.4 CO<sub>2</sub>-alarm systems

For the general design and construction of CO<sub>2</sub> alarm systems, see [Rules for Machinery Installations \(Pt.1, Vol III\) Sec.12.G.](#) and [H.](#)



**5.4.1** For machinery spaces, boiler, cargo pump rooms and similar spaces audible alarms of horn or siren sound and optical alarms are to be provided which shall be independent of the discharge of CO<sub>2</sub>. The audible warning is to be automatically actuated a suitable time before flooding occurs and is to be clearly distinguishable from all other alarm signals.

As adequate shall be considered the period of time necessary to evacuate the space to be flooded but not less than 20 seconds. The system is to be designed such that flooding is not possible before this period of time has elapsed.

The automatic actuation of the CO<sub>2</sub> alarm in the protected space may be realized by e.g. opening the door of the release station.

The emission of audible and optical alarms shall continue as long as the flooding valves are open.

An automatically trip of emergency shut-down facilities by the CO<sub>2</sub> alarm is not permitted (see [Rules for Machinery Installations \(Pt.1, Vol.III\) Sec.12.B.10.1](#)).

**5.4.2** Where adjoining and interconnecting spaces (e.g. machinery space, purifier room, machinery control room) have separate flooding systems, any danger to persons shall be excluded by suitable alarms in the adjoining spaces.

**5.4.3** Audible and optical alarms (pre-discharge alarms as defined in [5.4.1](#)) are also to be provided in ro-ro cargo spaces, spaces for the transport of reefer containers and other spaces where personnel can be expected to enter and where the access is therefore facilitated by doors or manway hatches. In conventional cargo spaces and small spaces, e.g. small compressor rooms, paint stores, etc., alarms may be dispensed with on application.

**5.4.4** CO<sub>2</sub>-alarm systems shall be supplied from the emergency switchboard.

**5.4.5** If the alarm is operated pneumatically, a permanent supply of compressed air for the alarm system is to be ensured.

**5.4.6** Alarm systems for the cargo area of tankers, see [Section 15](#).

## **5.5 Lift alarm**

**5.5.1** Lift cabins with internal controls shall be equipped with an audible emergency calling device which can be actuated from the lift cabin. The alarm shall be transferred to a permanently manned location.

**5.5.2** A telephone (sound powered, battery operated or electrically powered), or equivalent means of communication, shall be permanently installed in lift cabins with internal controls and connected to a permanently manned location.

**5.5.3** The emergency calling system and the telephone shall be supplied from the emergency source of electrical power and shall be independent of the power and control system.

## **5.6 Refrigerating hold closure alarm**

A closure alarm shall be provided to a permanently-manned location. The system shall initiate an alarm immediately. Illuminated switches situated near the access doors of each refrigerated space shall be installed.

## **D. Ship Safety Systems**

### **1. General emergency alarm**

#### **1.1 General**

**1.1.1** The general emergency alarm system is to be capable of sounding the general emergency alarm signal consisting of seven or more short blast followed by one long blast on the ship's whistle or siren and additionally on an electrically operated bell or klaxon or other equivalent warning system, which is to

be powered from the ship's main supply and the emergency source of electrical power required by SOLAS regulation II-1/42 or II-1/43, as appropriate. The system is to be capable of operation from navigation bridge and, except for the ship's whistle, also from other strategic points. The alarm is to continue to function after it has been triggered until it is manually turned off or is temporarily interrupted by a message on the public-address system.

**1.1.2** Ships of more than 500 GT shall be provided with an alarm system to alert the passengers and/or the crew or to call them to the assembly points. It shall be possible to release the alarm from the bridge and, except for the ship's whistle, also from other strategic important locations. The lifeboat station, when also musters station, fire control station and cargo control station shall be considered as strategic points.

**1.1.3** Means for announcement shall be provided in a sufficient number to ensure that all persons inside the accommodation and normal crew working spaces are alerted.

**Note:**

*Regarding the required sound pressure level, the IMO LSA Code (Resolution MSC.48/66) chapter VII, 7.2.1 shall be observed.*

*Requirement for measuring distance of sound pressure the FSS Code Ch.9 2.5.1.9 and IMO Alarm and Indicator Code shall be observed.*

**1.1.4** In noisy rooms, additional optical means of alarm may be required.

**1.1.5** Once released, the alarm shall sound continuously until it is switched off manually or is temporarily interrupted for an announcement through the PA-system.

**1.1.6** Entertainment systems shall be automatically turned off if the general emergency alarm is announced.

**1.1.7** Cables for general emergency alarm installations and for loudspeaker systems shall be acc. to [Section 12.D.15](#).

**1.1.8** The general emergency alarm shall be powered from the ship's main supply and the emergency source of electrical power.

## **2. Public address system (PA system)**

**2.1** In addition to the general emergency alarm system, a public-address system is required which can be operated from the navigation bridge and at least two other strategic points. The lifeboat station, fire control station and cargo control station shall be considered as strategic points. The public-address system shall be audible throughout the accommodation area, at the crew's normal working places and at the strategic important locations.

**2.2** If the public-address system is used to announce the general emergency alarm, the following requirements shall be fulfilled:

- The requirements for the general emergency alarm shall be fulfilled.
- At least two loudspeaker circuits supplied from separate amplifiers, shall be installed in each fire zone, respectively in its subdivisions.
- The loudspeaker circuits shall be so arranged that an announcement at a reduced acoustic irradiation is maintained in the event of a failure of an amplifier or loudspeaker circuit.
- The system shall be so arranged to minimize the effect of a single failure, by the use of at least two amplifiers, segregated supply with fuse protection, segregated cable routes and segregated arrangement.
- Where loudspeakers with built-in volume controls are used, the volume controls shall be disabled by the release of the alarm signal.
- It shall be possible to transmit the undistorted and clearly audible alarm signal at all times. Other simultaneous transmissions shall be automatically interrupted.

2.3 It shall be possible to operate all loudspeakers at the same time.

2.4 The PA-system shall be designed under observance of the minimum required sound level.

In a case of emergency, the announcements in all areas shall be understandable and above the ambient noise.

Announcement via microphone shall be free of acoustical feedback and other disturbances.

### 3. Fire detection and fire alarm systems

#### 3.1 General

See [Rules for Machinery Installations \(Pt.1, Vol.III\) Sec.12.](#)

3.1.1 Fire detection and fire alarm systems are subject to mandatory type approval.

3.1.2 The central fire alarm panel shall be located on the bridge or in the main fire control station.

One indicating unit shall be placed on the bridge if the central fire alarm panel is not located there.

3.1.3 Identifying devices, central fire alarm panel or fire indicator board shall indicate the section in which a fire detector has been activated. At least one indicating unit shall be so located that it is at all times accessible to responsible crew members.

3.1.4 On the fire indicating units or on the central fire alarm panel, clear information shall be provided showing which rooms are monitored, and where the individual sections are located.

3.1.5 The fire detection system shall be self-monitored. Faults, such as a supply failure, short-circuit or wire break in detection loops, the removal of a detector from its base and earth fault in detection loops with all-pole insulation shall be optically and audibly signalled at the central fire alarm panel. Fault alarms shall be acknowledgeable and distinguishable from a fire alarm.

**Note:**

*Loop is defined as electrical circuit linking detectors of various sections in a sequence and connected (input and output) to the indicating unit(s).*

3.1.6 Short-circuit or disconnection of the signal transfer between the fire detection system and the controller of fire safety systems, fire alarm systems or alarm devices shall be provided.

3.1.7 The emission of audible and optical alarms shall continue until they are acknowledged at the central fire alarm panel. If only a repeater is installed on the bridge, the acknowledgement of the audible alarm on the fire indicating unit shall be independent from the central fire alarm panel. Acknowledgement shall not disconnect the detection loop, nor shall it suppress further alarm signals in other detection loops.

The control panel shall clearly distinguish between normal, alarm, acknowledged alarm, fault and silenced conditions.

3.1.8 The fixed fire detection and fire alarm systems shall be arranged to automatically reset to the normal operating condition after alarm and fault conditions are cleared.

3.1.9 The central station shall be provided with means for testing and disconnecting of individual detectors or detector loops. When a particular detector/detector loop is disconnected, this shall be clearly recognizable.

Means for such recognition shall be provided for each loop.

The failure or disconnection of one detector loop shall not affect the operation of another detector loop.

The simultaneous response of detectors shall not impair the operation of the system.

3.1.10 The fire alarm shall be audible and optical recognized on the fire control panel, on the indicating units and by a responsible engineer officer without any time delay. If a fire alarm is not acknowledged within two minutes, an audible alarm shall be automatically released in all crew accommodation areas, service rooms, control stations and category A machinery spaces. This alarm system need not to be integrated into the fire detection system. The general emergency alarm signalling appliances may be used for this purpose.

**3.1.11** Fire detection systems shall not be used for other purposes, except for the automatic closure of fire doors, shut-off fans, closure of fire dampers, sprinkler systems, smoke extraction systems, low-location lighting systems, fixed local application fire-extinguishing systems, CCTV systems, paging systems, fire alarm, PA-systems or other fire safety systems.

Automatic stopping of engine room fans and appropriate flaps is not permitted.

**3.1.12** Automatic fire detectors shall respond to heat, smoke or other combustion products, flames or a combination of these factors. Detectors which are activated by other factors may be approved, provided they are not less sensitive than the aforementioned detectors.

**3.1.13** Smoke detectors required in all stairways, corridors and escape routes within accommodation spaces shall be certified to operate before the smoke density exceeds 12.5 % obscuration per metre, but not until the smoke density exceeds 2 % obscuration per metre.

**3.1.14** Heat detectors shall be actuated at a temperature of between 54 °C and 78 °C when the temperature rises to those limits at a rate of rise less than 1 °C per minute. In case of a faster temperature rise a higher threshold, value may be permitted by agreement with BKI.

**3.1.15** In rooms with especially high ambient temperatures (e.g. drying rooms), the operation temperature of heat detectors may be up to 130 °C, and up to 140 °C in saunas.

For passenger ships carrying more than 36 passengers, see requirement in [Section 14.D.4.1](#)

**3.1.16** If the fire detection system is not designed for remote and individual identification of detectors, it is not permitted that one zone may monitor more than one deck within the accommodation, service rooms and control stations, except of a zone which monitors closed staircases. To avoid delay locating the fire, the number of closed rooms monitored in any one zone is limited to a maximum of 50.

If the fire detection system is designed for remote and individual identification of detectors, the zones may monitor several decks and any number of closed rooms.

**3.1.17** A section of fire detectors and manually operated call points shall not be situated in more than one main vertical zone.

**3.1.18** Smoke detectors shall be used in passage-ways, stairways and escape routes.

Detectors in stairways shall be located at least at the top level of the stair and at every second level beneath.

Heat detectors shall normally be used only in cabins in the accommodation area.

**3.1.19** Flame detectors shall only be used in addition to the detectors mandatory required.

**3.1.20** All fire detectors shall be so designed that they remain serviceable, without the replacement of components, when passed regular testing.

**3.1.21** If it is not recognizable at the central fire alarm panel which detector has responded, an optical indication shall be provided on each detector itself. This indication shall remain displayed until the loop has been reset on the central fire alarm panel.

**3.1.22** The detectors are to be mounted in such a way that they can operate properly. Mounting places near ventilators, where the operation of detectors may be impaired or where mechanical damage is expected, shall be avoided.

Detectors mounted to the ceiling shall generally be placed at least 0,5 metre away from bulkheads, except in corridors, lockers and stairways.

The maximum monitored area, respectively the maximum distance between detectors shall not exceed the following values:

- Heat detectors 37 m<sup>2</sup> or distance not more than 9 metres
- Smoke detectors 74 m<sup>2</sup> or distance not more than 11 metres

The distance from bulkheads shall not exceed:

- 4,5 metres for heat detectors
- 5,5 meters for smoke detectors

**3.1.23** Manually operated call points shall be provided in the accommodation area, the service areas and control stations.

A manually operated call point shall be fitted at every exit. Manually operated call points are not required to be installed for each exit at the navigation bridge, in case, where the fire alarm panel is located at the navigation bridge.

Manually operated call points shall be readily accessible on every deck in the passageways, i.e. no part of the passageway shall be more than 20 metres far from a manually operated call point. Service spaces and control stations which have only one access, leading directly to the open deck, shall have a manually operated call point not more than 20 metres (measured along the access route using the deck, stairs and/or corridors) from the exit.

**3.1.24** A section of fire detectors which covers a control station, a service space or an accommodation space shall not simultaneously include a machinery space of category A or a ro-ro space. A section of fire detectors which covers a ro-ro space shall not include a machinery space of category A.

**3.1.25** Fire detectors shall be arranged in sections or detector loops. Activation of a fire detector shall initiate an optical and audible alarm in the central fire alarm panel and at the additional indicating devices.

**3.1.26** Cables forming part of the fire detection system shall be so arranged as to avoid touching galleys, category A machinery spaces and other closed spaces with a high fire risk, except if it is necessary to transmit a fire signal from these spaces, to initiate a fire alarm in these spaces, or to make the connection to the appropriate source of electrical power.

Fire detection systems with a loop-wise indication shall be so designed that

- a loop cannot be damaged at more than one point by a fire
- equipment is available which ensures that a fault in the loop (e.g. wire break, short circuit, earth fault) does not cause failure of the entire control unit
- all possible precautions have been taken to allow the function of the system to be restored in the event of a failure (electrical, electronic, affecting data processing)
- the first fire alarm indicated does not prevent the indication of further alarms by other fire detectors in other loops.

## **3.2 Power supply**

**3.2.1** The fire alarm system shall be supplied from the main and emergency source of electrical power. Should one supply fail, automatic change-over to the other power supply shall take place in, or close to, the central fire alarm panel. The change-over shall be signalled optically and audibly.

### **3.2.2 Continuity of power supply**

**.1** Operation of the automatic changeover switch or a failure of one of the power supplies shall not result in permanent or temporary degradation of the fire detection and fire alarm system.

**.2** Where the fire detection and fire alarm system would be degraded by the momentary loss of power, a source of stored energy having adequate capacity shall be provided to ensure the continuous operation during changeover between power supplies.

**.3** The arrangement of electrical power supplies to an automatic changeover switch shall be such that a fault will not result in the loss of all supplies to the automatic changeover switch.

**.4** There shall be sufficient power to permit the continued operation of the system with all detectors activated, but not more than 100 if the total exceeds this figure.

### 3.2.3 Emergency supply

.1 The fire detection and fire alarm system emergency power may be supplied by an accumulator battery or from the emergency switchboard. Where the system is supplied from an accumulator battery, the arrangements are to comply with the following requirements:

- the accumulator battery shall have the capacity to operate the fire detection system under normal and alarm conditions during the period required by [Section 3.C.](#) for the emergency source of power supply.
- the rating of the charge unit, on restoration of the input power, shall be sufficient to recharge the batteries while maintaining the output supply to the fire detection system.
- the accumulator batteries shall be within the fire detection and fire alarm panel or situated in another location suitable to provide a supply in the event of an emergency.

**Note:**

*Requirements for Storage Batteries, Chargers and Uninterruptible Power Supplies (UPS), see [Section 20.D.](#)*

.2 Where the emergency feeder for the electrical equipment used in the operation of the fixed fire detection and fire alarm system is supplied from the emergency switchboard, it shall run from this switchboard to the automatic changeover switch without passing through any other switchboard.

### 3.3 Fire detection systems with remotely and individually identified detectors

3.3.1 The fire detection system shall meet the requirements set out in [3.1](#) correspondingly.

3.3.2 Where addressable detectors are used, each such detector shall be indicated at the central fire alarm panel, and the audible alarm according to regulations shall be initiated.

3.3.3 Where the detectors in the alarm mode are not all simultaneously indicated at the central fire alarm panel, the central panel shall have the means of scanning all the detectors which have responded in order to establish clearly whether other detectors are in the alarm mode besides the one indicated.

3.3.4 A detection loop shall comprise not more than one fire zone or one watertight division.

3.3.5 If the fire detection system comprises remotely and individually identified detectors the loops may monitor several decks and any number of closed rooms.

3.3.6 For fixed fire detection systems with remotely and individually identifiable fire detectors, a section covering fire detectors in accommodation, service spaces and control stations shall not include fire detectors in machinery spaces of category A or Ro-Ro spaces.

3.3.7 The detector loop shall be so arranged within a fire section/part of a fire subdivision that in the event of damage, e.g. wire break, a short-circuit or a fire, only the affected deck becomes faulty.

The spatial arrangement of the loops shall be submitted for approval.

3.3.8 All arrangements are made to enable the initial configuration of the system to be restored in the event of failure (e.g., electrical, electronic, informatics, etc.).

### 3.4 Fire detection and alarm systems for cargo ships

In [Rules for Machinery Installations \(Pt.1, Vol.III\) Sec.12.C.](#) the following fire detection and alarm systems shall be provided in accordance with the type of construction of the accommodation areas:

#### 3.4.1 Structural fire protection method IC

A smoke detecting system, including manually operated call points, shall be provided for corridors, staircases and escape routes within the accommodation areas.

### 3.4.2 Structural fire protection method IIC

An automatic sprinkler system, including alarm devices in accordance with [Rules for Machinery Installations \(Pt.1, Vol.III\) Sec.12.C.3.2](#), shall be provided for accommodation and service rooms (for flow-and fire signals, see also 3.4).

A smoke detecting system is additionally to be provided for corridors, staircases and escape routes within the accommodation areas.

Rooms in which no fire hazard exists, e.g. void spaces, sanitary rooms etc., need not to be monitored.

### 3.4.3 Structural fire protection method IIIC

An automatic fire alarm and detection system, including manually operated call points, shall be provided for the entire accommodation area with the exception of those spaces in which no fire hazard exists.

## 3.5 Fire detection and alarm systems on ships with water spray systems (sprinkler)

[Rules for Machinery Installations \(Pt.1, Vol.III\) Sec.12.L](#). shall be observed.

**3.5.1** Ships which shall be equipped with an automatic water spray system (sprinkler) in accordance with SOLAS shall be additionally provided with a fire detection and alarm system with automatic smoke detectors and manually operated call points with displays on the navigating bridge in accordance with 3.1.

**3.5.2** Where the accommodation and public rooms are fitted with sprinkler systems, the alarm devices shall meet the following requirements:

Each section of sprinklers shall include means of releasing automatically a visual and audible alarm signal at one or more indicating units whenever sprinkler comes into operation. Such units shall indicate in which section a sprinkler has come to operation and shall be centralized on the navigation bridge and in addition, visible and audible alarms from the unit shall be located in a position other than on the navigation bridge, so as to ensure that the indication of the fire is immediately received by the crew.

With regard to self-monitoring and to the electrical power supply, the alarm system shall be designed corresponding to a fire detection system according to 3.1.

## 3.6 Fire detection and alarm systems for unattended machinery spaces

**3.6.1** For unattended machinery spaces of category A in accordance with [Rules for Automations \(Pt.1, Vol.VII\)](#), an automatic fire detection system shall be provided which detects a fire already in its initial stage, e.g. systems with smoke detectors.

General requirements see 3.1 and 3.2.

**3.6.2** The fire alarm shall be optical and audible recognized on the bridge, in the accommodation and mess areas of the engineer officers or the crew member responsible for the machinery plant and also in the machinery space and it shall be distinguishable from other alarms. The fire alarm shall be executed in machinery space without any time delay.

## 3.7 Fire detection and fire alarm systems for cargo holds

**3.7.1** For smoke detection system 3. is to be observed.

### 3.7.2 Sample extraction smoke detection system

.1 Sample extraction smoke detection systems are subject to mandatory type approval.

.2 Each sample extraction smoke detection system shall operate continuously. Systems operating on the scanning principle may be approved, provided that the interval between the detection cycles at the same measuring point is not excessive long.

.3 The two power supplies required for the operation of the suction-type smoke detection system shall be monitored for failure. Each power failure shall release an optical and audible signal in the control unit and on the bridge, distinguishable from the smoke detection signal.

.4 The control unit shall be located on the bridge or in the main fire control station.

One indicating unit shall be placed on the bridge if the central fire alarm panel is not located there.

The control panel shall clearly distinguish between normal, alarm, acknowledged alarm, fault and silenced conditions.

.5 The emission of audible and optical alarms shall continue until they are acknowledged at the control unit. If only a repeater is installed on the bridge, the acknowledgement of the audible alarm on the fire indicating unit shall be independent from the control unit.

.6 The sample extraction smoke detection system shall be arranged to automatically reset to the normal operating condition after alarm and fault conditions are cleared.

.7 The detection of smoke or other combustion products shall release an optical and audible signal in the control unit and on the bridge.

.8 The monitored spaces shall be clearly identified at, or close to, the control unit.

.9 Proof is required that the response sensitivity of the suction-type smoke detection system is below 6,65 % obscuration per metre.

.10 Two switchover extraction fans are to be provided, each of them shall be sufficient for the duty involved.

.11 If explosive gas-/air mixtures or vapours can be sucked in by the smoke detection system, explosion protection shall be provided, see [Sections 16](#) and [17](#).

.12 The monitoring device shall enable the observation of smoke in the individual sampling pipes.

.13 The air flow through the individual sampling pipes shall be monitored. As far as possible, provision shall be made that equal quantities of air to be drawn from each connected sampling unit.

.14 The system shall be of a type that can be tested for correct operation and restored to normal surveillance without the renewal of any component.

**3.7.3** Fire detection in cargo spaces for transporting packaged dangerous goods, see also [Rules for Machinery Installations \(Pt.1, Vol.III\) Sec.12.P.5](#).

#### **4. Fixed water-based local application fire-fighting systems (FWBLAFFS)**

**4.1** The Construction [Rules for Machinery Installations \(Pt.1, Vol.III\) Sec.12.L.3](#). shall be observed.

Flame detectors, remotely controlled valves, control electronics and fire detection systems used for FWBLAFFS are subject to mandatory type testing.

**4.2** The fire detection system shall be self-monitored. Faults, such as a supply failure, short circuit or wire break in detection loops, the removal of a detector from its base and earth fault in detection loops with all-pole insulation shall be optically and audibly signalled at the central fire alarm panel. Fault alarms shall be acknowledgeable and, wherever possible, distinguishable from a fire alarm.

The emission of audible and optical alarms shall continue until they are acknowledged at the central fire alarms panel. Acknowledgement of the audible fire alarm shall be made before acknowledgement of the optical fire alarm. The acknowledgements of audible and optical fire alarm signals shall be independent of each other. Acknowledgement shall not disconnect the detection loop, nor shall it suppress further alarm signals in other detection loops.

In case the evaluation unit is part of the ship's main fire alarm panel, detectors and control units shall be separated from the main fire alarm system by using separate loops only for the purpose of FWBLAFFS.



4.3 In case of periodically unattended machinery space the FWBLAFFS shall have both automatic and manual release capabilities.

The automatic release shall have a manual stop function in case of a spurious release. The manual release shall be independent from the fire alarm panel.

For continuously manned machinery space only a manual release capability is required.

4.4 The manual release shall be located at easily accessible positions, adjacent to the protected area. Additional to this local release it shall be possible to release the FWBLAFFS from a safe position outside the engine room.

The installation inside the space should not be liable to be cut off by a fire in the protected areas

#### 4.5 Detector initiating philosophy

4.5.1 Fire detectors shall be flame detectors. The viewing angle shall be adjusted to the monitored area only.

4.5.2 For each monitored area two detectors are needed to detect a fire before initiating the release. Activation of a single detector shall cause an alarm. The detectors shall operate with a maximum delay time of 10 seconds.

4.5.3 Other configuration of detectors concerning type and release philosophy shall be agreed with BKI.

4.6 The outputs, which activate the valves, shall be designed so that potential faults such as loss of voltage or a broken wire for example shall not create a spurious release.

4.7 Activation of any local application system shall give a visual and distinct audible alarm in the machinery space and at a continuously manned station. This alarm shall indicate the specific system activated.

#### 4.8 Ingress protection

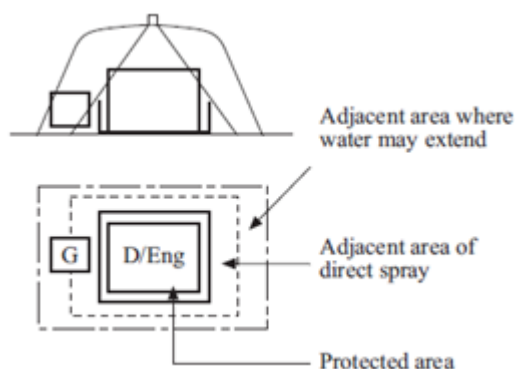

Figure 9.1:

#### Definitions:

Protected space : Is a machinery space where a FWBLAFFS is installed.

Protected areas : Areas within a protected space which is required to be protected by FWBLAFFS.

Adjacent areas : Areas, other than protected areas, exposed to direct spray or areas, other than those defined above, where water may extend.

Where it is necessary to install equipment within FWBLAFFS protected areas, the following precautions are to be taken:

4.8.1 Operation controls and other electrical and electronic equipment enclosures located in reach of the FWBLAFFS in the protected area and those within adjacent areas exposed to direct spray shall have as a minimum the degree of protection IP44, except where evidence of suitability is submitted to and approved by BKI.

**4.8.2** IP-degree lower than IP44 for the mentioned electrical and electronic equipment within adjacent areas not exposed to direct spray may be approved with suitable evidence taking into account the design and equipment layout, e.g. position of inlet ventilation openings. The cooling air-flow for the equipment is to be assured.

**4.8.3** IP-degree lower than IP44 for the mentioned electrical and electronic equipment within adjacent areas not exposed to direct spray may be approved with suitable evidence taking into account the design and equipment layout, e.g. position of inlet ventilation openings. The cooling air-flow for the equipment is to be assured.

**4.9** Components of the system such as pumps and valves requiring an external power source shall be supplied by the main power source

**4.10** The FWBLAFFS shall provide means for testing the automatic release without delivering water into the protected areas. Each protected area shall be periodically tested.

**4.11** Operating and maintenance instructions for the system and the cleaning interval for the optical parts of the detectors shall be displayed at each operating position and verified in practical operation.

## **5. Watertight doors and openings in cargo ships (Watertight door control system)**

For watertight doors and openings relevant to the stability of the ship in the damaged state, control and monitoring devices shall be provided as follows.

**5.1** [Rules for Machinery Installations \(Pt.1, Vol.III\) Sec.14.F.5.](#) shall be observed.

**5.2** Optical indicators showing whether the door is closed or open shall be provided at the remote-control position. Closing of the door shall be announced on the spot by an audible signal.

**5.3** Access doors and access hatch covers normally closed at sea shall be provided with means of monitoring. Indicators shall show locally and, on the bridge, whether these doors or hatch covers are open or closed.

**5.4** A failure of control system shall be signalled optical and acoustically on the bridge.

**5.5** The operating console on the bridge shall be provided with a system schema from which the arrangement of the watertight doors in the ship can be recognised.

## **6. Bilge level monitoring**

For the extent and design of the bilge level monitoring, see the [Rules for Machinery Installations \(Pt.1, Vol.III\) Sec.1.E.5.](#)

## **7. Voyage Data Recorder (VDR)**

**7.1** The Voyage Data Recorder should be supplied from the main and emergency switchboard, see [Section 4.1.9.1](#) and [9.3](#)

**7.2** Data or alarms for the Voyage Data Recorder have to be free of reactive effects to ship operation.

## **8. Ballast water treatment plants**

**8.1** Ballast water treatment plants (BWTS) are to be approved by a flag administration according to IMO Resolution MEPC 174(58), MEPC.169(57) respectively. The obligation to install a ballast water treatment plant depends on the ballast water capacity and keel laying date of the ship. Refer to International Convention "For The Control And Management of Ship's Ballast Water and Sediments", 2004 – Regulation B-3.

**8.2** For BWTS these construction Rules are to be observed and [Rules for Automations \(Pt.1, Vol.VII\)](#), if applicable.

**8.3** BWTS shall in addition comply with [Rules for Machinery Installations \(Pt.1, Vol.III\) Sec. 8](#) and [11](#).

**8.4** For the electrical appliances the following documentation to be submitted for approval for each project:

- system description with technical data's,
- wiring diagrams,
- power balance, and
- further documents necessary for the review of the construction.

**8.5** On manufacturer's application, BKI may issue an approval Certificate confirming compliance with Rules as referred above.

**8.6** In case of BWTS for which compliance with Rules have already been confirmed within the BKI approval Certificate, the typical documentation does not need to be submitted for approval again. Ships related documentation for the individual installation may be necessary for review.

**8.7** For a BKI approval of a BWTS evidence to be provided, that the components are designed to withstand the environmental strength

## **9. Control valve**

**9.1** The following requirements are applicable to valves whose failure could impair essential services.

**9.2** Failure of the power supply is not to permit a valve to move to an unsafe condition.

**9.3** An indication is to be provided at the remote-control station showing the actual position of the valve or whether the valve is fully open or fully closed. This indication may be omitted for quick-closing valves.

**9.4** When valves are remote controlled, a secondary means of operating them is to be provided which may be manual control.

*This page intentionally left blank*

## Section 10 Computer Systems

A.	General . . . . .	10-1
B.	Approval of system and components . . . . .	10-5
C.	System categories . . . . .	10-6
D.	Requirements on development and certification of computer-based system . . . . .	10-6
E.	Requirements on maintenance of computer-based systems . . . . .	10-13
F.	Management of change . . . . .	10-14
G.	Technical requirements on computer-based systems . . . . .	10-17

### A. General

#### 1. Scope

These requirements apply to design, construction, commissioning and maintenance of computer-based systems where they depend on software for the proper achievement of their functions.

These requirements apply to **systems which provide control, alarm, monitoring, safety, or internal vessel communication functions that** subject to classification requirements.

#### 2. Exclusion

**Computer-based systems that are covered by statutory regulations are excluded from the requirements of Section.**

**Examples of such systems are navigation systems and radio communication system required by SOLAS chapter V and IV, and vessel loading instrument/stability computer.**

**For loading instrument/stability computer, Guidance for Marine Industry (Pt.1, Vol.AC) Sec.2 R-48 may be considered.**

#### 3. Structure

**The general certification requirements for computer-based systems and the relation to type approval is described in A.4.2. The requirements and extent of verification of a computer-based system depends on its categorization into one of three categories. The categories are described in B.2..**

**The requirements of this Section cover the lifecycle of computer-based system from design through operations. The requirements are split into groups representing the different phases of the life cycle and the roles responsible for fulfilling the requirements.**

**The activities related to the development and delivery of a computer-based system is described in C.3., while the activities related to the maintenance in the operational phase are described in D.3.8.**

**Management of changes to software and systems is given special attention in this Section, and the main aspects of a management of change process are described in E.3.2.**

**Most requirements in this Section are related to the way of working, and thus focus on activities to be performed, but it also contains some technical requirements. The technical requirements on computer-based systems have been gathered in F.12.2.**

## 4. Definition of abbreviations and terminology

### 4.1 Abbreviations

Table 10.1: Abbreviations

Abbreviation	Expansion
Cat I	Category one systems as defined in paragraph C.1.
Cat II	Category two systems as defined in paragraph C.1.
Cat III	Category three systems as defined in paragraph C.1.
COTS	Commercial off-the-shelf
FAT	Factory acceptance test
FMEA	Failure mode and effect analysis
IT	Information technology
OT	Operational technology
PMS	Planned maintenance system
SAT	System acceptance test
SOST	System of systems test
SSLS	Ship software logging system

## 4.2 Terminology

**Table 10.2: Terminology**

Term	Definition
Black-box description	A description of a system's functionality and behaviour and performance as observed from outside the system in question
Black-box test methods	Verification of the functionality, performance, and robustness of a system, sub-system or component by only manipulating the inputs and observing the outputs. This does not require any knowledge of the system's inner workings and focuses only on the observable behaviour of the system/component under test in order to achieve the desired level of verification
Computer-based system (CBS)	A programmable electronic device, or interoperable set of programmable electronic devices, organized to achieve one or more specified purposes such as collection, processing, maintenance, use, sharing, dissemination, or disposition of information. CBSs onboard include IT and OT systems. A CBS may be a combination of subsystems connected via network. Onboard CBSs may be connected directly or via public means of communications (e.g. Internet) to ashore CBSs, other vessels' CBSs and/or other facilities.
Failure mode description	<p>A document describing the effects due to failures in the system, not failures in the equipment supported by the system. The following aspects shall be covered:</p> <ul style="list-style-type: none"> <li>- list of failures which are subject to assessment, with</li> <li>- description of the system response to each of the above failures</li> <li>- comments to the consequence of each of these failures</li> </ul>
Owner	The organization or person which orders the vessel in the construction phase or the organization which owns or manages the vessel in service. In the context of this Section this is a defined role with specific responsibilities.
Parameterization	To configure and tune system and software functionality by changing parameters. It does not usually require-computer programming and is normally done by the system supplier or a service provider, not the operator or end-user.
Programmable device	Physical component where software is installed
Robustness	The ability to respond to abnormal inputs and conditions
Service supplier	A person or company, not employed by BKI, who at the request of an equipment manufacturer, shipyard, vessel's owner or other client acts in connection with inspection work and provides services for a ship or a mobile offshore unit such as measurements, tests or maintenance of safety systems and equipment, the results of which are used by surveyors in making decisions affecting classification or statutory certification and services
Simulation test	Monitoring, control, or safety system testing where the equipment under control is partly or fully replaced with simulation tools, or where parts of the communication network and lines are replaced with simulation tools.

**Table 10.2: Terminology (continued)**

Term	Definition
BKI Certificate	Compliance document issued by BKI stating: <ul style="list-style-type: none"> <li>- conformity with applicable rules and requirements.</li> <li>- that the tests and inspections have been carried out on:               <ul style="list-style-type: none"> <li>- the finished certified component itself; or</li> <li>- on samples taken from earlier stages in the production of the component, when applicable.</li> </ul> </li> <li>- that the inspection and tests were performed in the presence of the Surveyor or in accordance with special agreements, i.e. Alternative Certification Scheme (ACS)</li> </ul>
Software component	A standalone piece of code that provides specific and closely coupled functionality.
Software master files	The computer-files that constitutes the original source of the software. For custom made software this may be readable source code files, and for COTS software it may be different forms of binary files.
Software-structure	Overview of how the different software components interact and is commonly referred to as the Software Architecture, or Software Hierarchy
Sub-system	Identifiable part of a system, which may perform a specific function or set of functions.
Supplier	A generic term used for any organisation or person that is a contracted or a subcontracted provider of services, system components, or software.
System	A combination of components, equipment and logic which has a defined purpose, functionality, and performance. In the context of this Section, a specific system is delivered by one system supplier
System of systems	A system which is made up of several systems, In the context of this Section, the system of systems encompasses all monitoring, control and safety systems delivered from the Shipyard as a part of a vessel
System supplier	An organisation or person that is contracted or a subcontracted provider of system components or software under the coordination of the Systems integrator. In the context of this Section this is a defined role with specific responsibilities.
System integrator	Single organization or a person coordinating interaction between suppliers of systems and sub-systems on all stages of life cycle of computer-based systems in order to integrate them into a verified vessel-wide system of systems and to provide proper operation and maintenance of the computerbased systems. In the context of this Section this is a defined role with specific responsibilities. During the design and delivery phase the Shipyard is the default Systems integrator, during operations phase the Owner is the default.
Type approval Certificate	Compliance document issued by a BKI by which the BKI declares that a product design meets a minimum set of technical requirements
Vessel	Ship or offshore unit where the computer-based system is to be installed.



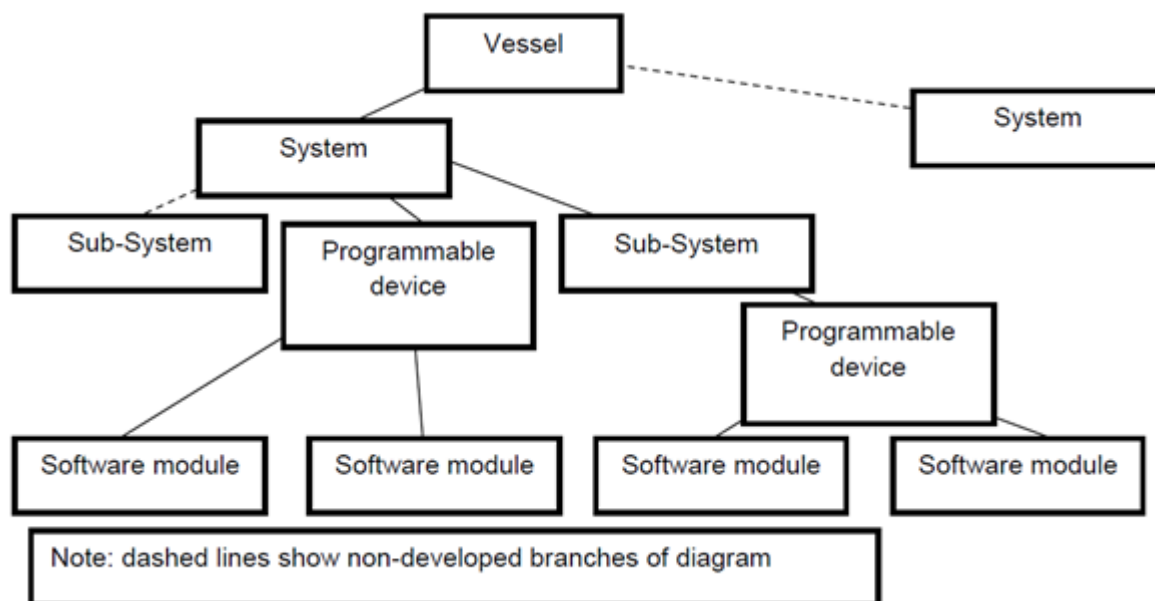

Figure 10.1: Illustrative system hierarchy

## B. Approval of system and components

### 1. System certification

Computer-based systems that are necessary to accomplish vessel-functions of category II or category III (as defined in C.1. below) shall be delivered with a vessel-specific BKI certificate. The objective of the vessel-specific system certification is to confirm that design and manufacturing of the system has been completed and that the system complies with applicable BKI rules.

Vessel-specific system certification consist of two main verification activities:

- 1) Assessment of vessel-specific documentation (see D.2. and E.3.2)
- 2) Survey and testing of the system to be delivered to the vessel (see D.2.7)

BKI may accept Alternative Certification Scheme (ACS) provided that the requirements are met, and that the system is provided with a vessel-specific certificate.

### 2. Type approval of computer-based systems

Computer-based systems that are routinely manufactured and include standardized software functions may be type approved in accordance with specified BKI rules. Hardware shall be documented according to the requirement in D.2.4.

The type approval consist of two main verification activities:

- 1) Assessment of type-specific documentation
- 2) Survey and testing of the standardized functions

Type approval will normally not yield exemption from vessel-specific system certification since vessel-specific functions, parameter configurations and installation elements demand vessel specific verification.

## C. System categories

### 1. System category definitions

The categorization of a system in the context of this Section is based on the potential severity of the consequences if the system serving the function fails. [Table 10.4](#) provides the definitions of the categories.

**Table 10.4: System categories**

Category	Failure effects	Typical system functionality
I	Those systems, failure of which will not lead to dangerous situations for human safety, safety of the vessel and/or threat to the environment.	- Monitoring, informational and administrative functions
II	Those systems, failure of which could eventually lead to dangerous situations for human safety, safety of the vessel and/or threat to the environment.	Vessel alarm, monitoring and control functions which are necessary to maintain the ship in its normal operational and habitable conditions
III	Those systems, failure of which could immediately lead to dangerous or catastrophic for human safety, safety of the vessel and/or threat to the environment.	- Control functions for maintaining the vessel's propulsion and steering - Vessel safety functions

### 2. Class Societies' scope

Category I systems are normally not subject to verification by BKI, as failure of these systems shall not lead to dangerous situations. However, information pertinent to category I systems shall be required upon request to determine the correct category or ensure that they do not influence the operation of systems in category II and category III.

### 3. System category examples

The category of a system shall always be evaluated in the context of the specific vessel in question; thus, the categorization of a system may vary from one vessel to the next. This means that the examples of categories below are given as guidance only. For determining the categorization of systems for a specific vessel, see [D.3.3](#).

#### Examples of category I systems:

Fuel monitoring system, maintenance support system, diagnostics and troubleshooting system, closed circuit television, cabin security, entertainment system, fish detection system.

#### Examples of category II systems:

Fuel oil treatment system, alarm and monitoring and safety systems for propulsion and auxiliary machinery, Inert gas system, control, monitoring and safety system for cargo containment system.

#### Examples of category III systems:

Propulsion control system, steering gear control system, electric power system (including power management system), dynamic positioning system (IMO classes 2 and 3). The list of example systems is not exhaustive.

## D. Requirements on development and certification of computer-based system

### 1. General requirements

#### 1.1 Life cycle approach with appropriate standards

##### Requirement:

A global top-down approach shall be undertaken in the design and development of both hardware and software and the integration in sub-systems, systems, and system of systems, spanning the complete system lifecycle. This approach shall be based on the standards as listed herein or other standards recognized by BKI.

**Verification by BKI:**

This is verified by BKI as a part of the quality management system verification described in [D.1.2](#).

**1.2 Quality management system**

Systems integrators and system suppliers shall in the development of computer-based systems for category II and category III, comply to a recognised quality standard such as ISO 9001; also incorporating principles of IEC/ISO 90003.

The quality management system shall as a minimum include the following topics, applicable for both category II and category III systems:

**Table 10.5: System categories**

No.	Area Topic	Role	
		System supplier	System integrator
1	Responsibilities and competency of the staff.	X	X
2	The complete lifecycle of delivered software and of associated hardware	X	X
3	Specific procedure for unique identification of a computer-based system, it's components and versions.	X	
4	Creation and update of the vessel's system architecture		X
5	Organization set in place for acquisition of software and related hardware from suppliers	X	X
6	Organization set in place for software code writing and verification	X	
7	Organization set in place for system validation before integration in the vessel	X	
8	Specific procedure for conducting and approving of systems at FAT and SAT	X	X
9	Creation and update of system documentation	X	
10	Specific procedure for software modification and installation on board the vessel, including interactions with shipyard and owner	X	X
11	Specific procedures for verification of software code	X	
12	Procedures for integrating systems with other systems and testing of the system of systems for the vessel	X	X
13	Procedures for managing changes to software and configurations before FAT	X	
14	Procedures for managing and documenting changes to software and configurations after FAT	X	X
15	Checkpoints for the organization's own follow-up of adherence to the quality management system	X	X

**Verification by BKI:**

The quality management system may be verified by two alternative means:

- 1) BKI confirming that the quality management system is certified as compliant to a recognized standard by an organisation with accreditation under a national accreditation scheme.
- 2) BKI confirming compliance to a standard through a specific assessment of the quality management system. The documentation requirements will be defined per case.

## 2. Requirements on the system supplier

### 2.1 Define and follow a quality plan

**Requirement:**

The system supplier shall document that the quality management system is applied for the design, construction, delivery, and maintenance of the specific system to be delivered. All applicable items described in [D.1.2](#) (for the system supplier role) shall be demonstrated to exist and being followed, as relevant.

**Verification by BKI:**

Category I: No documentation required  
Category II and III: The quality plan shall be available during survey (FAT) or submitted for information upon request (FI).

### 2.2 Unique identification of systems and software

**Requirement:**

A method for unique identification of a system, its different software components and different revisions of the same software component shall be applied. The method shall be applied throughout the lifecycle of the system and the software.

See also [F.1.](#) for related technical requirements on the system in question. The documentation of the method is typically a part of the quality management system, see [D.1.2](#)

**Verification by BKI:**

Category I: Not required

Category II and III: Application of the identification system is verified as a part of the FAT ([D.2.7](#)) and SAT ([D.3.6](#))

### 2.3 System description

**Requirement:**

The system's specification and design shall be determined and documented in a system description. In addition to serve as a specification for the detailed design and implementation, the purpose of the system description is to document that the entire system-delivery is according to the specifications and in compliance with applicable rules and regulations.

The system description shall contain information of the following:

- Purpose and main functions, including any safety aspects
- System category as defined
- Key performance characteristics
- Compliance with the technical requirements and BKI rules
- User interfaces/mimics
- Communication and Interface aspects
  - Identification and description of interfaces to other vessel systems
- Hardware-arrangement related aspects:
  - Network-architecture/topology, including all network components like switches, routers, gateways, firewalls etc.

- Internal structure with regards to all interfaces and hardware nodes in the system (e.g. operator stations, displays, computers, programmable devices, sensors, actuators, I/O modules etc)
- I/O allocation (mapping of field devices to channel, communication link, hardware unit, logic function)
- Power supply arrangement
- Failure mode description

**Guidance:**

The information listed above is in this Section collectively referred to as the system description. It may however be divided into a number of different documents and models.

**Verification by BKI:**

Category I: The system description documentation shall upon request be submitted for information (FI).  
Category II and III: The system description documentation shall be submitted for approval (AP).

## 2.4 Environmental compliance of hardware components

**Requirement:**

Evidence of environmental type testing according to IACS UR E10 regarding hardware elements included in the system and sub-systems shall be submitted to BKI.

**Verification by BKI:**

Category I: This requirement is not mandatory for category I systems. Reference to Type approval certificate or other evidence of type testing shall upon request be submitted for information (FI) see C.2..

Category II and III: Reference to Type approval certificate or other evidence of type testing shall be submitted for information (FI).

## 2.5 Software code creation, parameterization, and testing

**Requirement:**

The software created, changed, or configured for the delivery project shall be developed and have the quality assurance activities assessed according to the selected standard(s) as described in the quality plan

The quality assurance activities may be performed on several levels of the software-structure and shall include both custom-made software and configured components (e.g. software libraries) as appropriate.

The verification of the software shall as a minimum verify the following aspects based on black-box methods:

- Correctness, completeness and consistency of any parameterization and configuration of software components
- Intended functionality
- Intended robustness

For components in systems of Category II and III, the scope, purpose, and results of all performed reviews, analyses, tests, and other verification activities shall be documented in test reports.

**Guidance:**

Some of the methods utilized in this activity are sometimes referred to as “software unit test” or “developer test” and may also include verification methods like code-reviews and static or dynamic code analysis.

**Verification by BKI:**

Category I: No documentation required  
Category II and III: Software test reports shall upon request be submitted for information (FI).

## 2.6 Internal system testing before FAT

### **Requirement:**

The system shall as far as practicable be tested before the FAT. The main purpose of the system test is for the system supplier to verify that the entire system delivery is according to the specifications, approved documentation and in compliance with applicable rules and regulations; and further, that the system is completed and ready for the FAT.

The testing shall at least verify the following aspects of the system:

- Functionality
- Effect of faults and failures (including diagnostic functions, detection, alerts response)
- Performance
- Integration between software and hardware components
- Human-machine interfaces
- Interfaces to other systems

Faults are to be simulated as realistically as possible to demonstrate appropriate system fault detection and system response.

Some of the testing may be performed by utilizing simulators and replica hardware

The test-environment shall be documented, including a description of any simulators, emulators, test-stubs, test-management tools, or other tools affecting the test environment and its limitations.

Test cases and test results shall be documented in test programs and test reports respectively.

### **Verification by BKI:**

Category I: No documentation required Category II and III: Internal system test report shall be made available during FAT or submitted upon request (FI)

## 2.7 Factory acceptance testing (FAT) before installation on board

### **Requirement:**

A factory acceptance test (FAT) shall be arranged for the system in question. The main purpose of the FAT is to demonstrate to BKI that the system is completed and compliant with applicable classification rules, thus enabling issuance of a BKI Certificate for the system.

The FAT test program shall cover a representative selection of the test items from the internal system test (described in [D.2.6](#)), including normal system functionality and response to failures.

For category II and III systems, network testing to verify the network resilience requirements in [G.2.1](#) shall be performed. If agreed by all parties, the network testing may be performed as a part of the system test onboard the vessel.

The FAT shall as a rule be performed with the project specific software operating on the actual hardware components to be installed on board, with necessary means for simulation of functions and failure responses, however other solutions such as replica hardware or simulated hardware (emulators) may be agreed with BKI.

For each test-case it shall be noted if the test passed or failed, and the test-results shall be documented in a test report. The test report shall also contain a list of the software (including software versions) that were installed in the system when the test was executed.

### **Guidance:**

For complex systems there may be a large difference in scope between the “Internal system testing before FAT” activity and the FAT, while for some systems the scope may be identical.

**Verification by BKI:**

Category I: FAT not required.

Category II and III: The FAT program shall be approved (AP) before the test is executed.

The FAT execution shall be witnessed by BKI.

The FAT report shall be submitted for information (FI).

Additional FAT documentation including e.g., user manuals and internal system test report shall be made available during FAT or submitted upon request for information (FI).

## 2.8 Secure and controlled software installation on the vessel

**Requirement:**

The initial installation and subsequent updates of the software components of the system shall be done according to a management of change procedure which has been agreed between the system supplier and the systems integrator.

The management of change procedure shall comply with the requirements in [E.3.2](#). Cyber security measures shall be observed as described in relevant IACS URs.

**Verification by BKI:**

Category I: Not required

Category II and III: The management of change procedure shall upon request be submitted for information (FI).

## 3. Requirements on the systems integrator

### 3.1 Responsibilities

For the purposes of this Section, the Shipyard is considered as the systems integrator in the development and delivery phase unless another organization or person is explicitly appointed by the Shipyard.

### 3.2 Define and follow a quality plan

**Requirement:**

The systems integrator shall document that the quality management system is applied for the installation, integration, completion, and maintenance of the systems to be installed on board. All applicable items described in [D.1.2](#) (for the systems integrator role) shall be demonstrated to exist and being followed, as relevant.

**Verification by BKI:**

Category I: No documentation required

Category II and III: The quality plan shall be made available during survey (at SAT/SOST) or upon request submitted for information (FI).

### 3.3 Determining the category of the system in question

**Requirement:**

For each system delivery to a particular vessel, it shall be decided which category the system falls under based on the failure effects of the system (as defined in [B.2](#)). The category for a specific system must be conveyed to the relevant system supplier. BKI may decide that a risk-assessment is needed to verify the proper system category.

### **Verification by BKI:**

Category I, II and III: The category for the different systems shall upon request be documented and submitted for approval (AP).

## **3.4 Risk assessment of the system**

### **Requirement:**

If requested by BKI, a risk assessment of a specific system in context of the specific vessel in question shall be performed and documented in order to determine the applicable category for the system

### **Guidance**

IEC/ISO31010 "Risk management - Risk assessment techniques" may be used as guidance in order to determine method of risk assessment.

Category I, II and III: The risk assessment report shall upon request be submitted for approval (AP).

## **3.5 Define the vessel's system-architecture**

### **Requirement:**

The system of systems (SoS) shall be specified and documented. This architecture specification provides the basis for category determination and development of the different integrated systems by allocating functionality to individual systems and by identifying the main interfaces between the systems. It shall also serve as a basis for the testing of the integrated systems on the vessel level (see [D.3.7](#)).

The vessel's system architecture shall at least contain description of:

- Overview of the total systems architecture (the system of systems)
- Each system's purpose and main functionality
- Communication and interface aspects between different systems

### **Guidance:**

See also section [24](#) for diagram of security zones and conduits

**Verification by BKI:** Category I, II, and III: The vessel's system architecture shall upon request be submitted for information (FI).

## **3.6 System acceptance test (SAT) onboard the vessel**

### **Requirement:**

A system acceptance test shall be arranged onboard the vessel. The main purpose of the system acceptance test (SAT) is to verify the system functionality, after installation and integration with the applicable machinery/electrical/process systems on board including possible interfaces with other control and monitoring systems.

For each test-case it shall be noted if the test passed or failed, and the test-results shall be documented in a test report. The test report shall also contain a list of the software (including software versions) that were installed in the system when the test was executed.

### **Verification by BKI:**

Category I: Not required.

Category II and III: The SAT program shall be submitted for approval (AP) before the test is executed.

The SAT execution shall be witnessed by BKI.

The SAT report shall be submitted for information (FI).



### 3.7 Testing of integrated systems on vessel-level (SOST)

#### **Requirement:**

Integration tests shall be conducted after installation and integration of the different systems in its final environment on board. The purpose of the tests is to verify the functionality of the complete installation (system of systems) including all interfaces and inter-dependencies in compliance with requirements and specifications.

The testing shall at least verify the following aspects of the system of systems:

- The overall functionality of the interacting systems as a whole
- Failure response between systems
- Performance
- Human-machine interfaces
- Interfaces between the different systems

#### **Guidance:**

For complex systems there may be a large difference in scope between the “System acceptance test (SAT) onboard the vessel” activity and the SOST, while for some systems the scope may be overlapping or identical. It is possible to combine the two activities into one when the test scope is similar.

#### **Verification by BKI:**

Category I: Not required.

Category II and III: The SOST program shall submitted for approval (AP) before the test is executed.

The SOST execution shall be witnessed by BKI.

The SOST report shall be submitted for information (FI).

### 3.8 Change management

The systems integrator shall follow procedures for management of change to the system as described in [E.3.2](#).

#### **Verification by BKI:**

Category I: No documentation requirements

Category II and III: The management of change procedure shall upon request be submitted for information (FI).

## **E. Requirements on maintenance of computer-based systems**

### **1. Requirements on the Vessel Owner**

#### **1.1 Responsibilities**

For the purposes of this Section, the vessel owner is considered to be the systems integrator in the operations phase unless another organization or person is explicitly appointed by the owner.

Accordingly, BKI shall in a timely manner be informed by the owner about the appointed systems integrator which is responsible for implementing any changes to the systems in conjunction with system supplier(s).

## 2. Requirements on the Systems integrator

### 2.1 Change management

**Requirement:**

The systems integrator shall ensure that necessary procedures for software and hardware change management exist on board, and that any software modification/upgrade are performed according to the procedure(s). For details about change management please see [E.3.2](#).

Changes to computer-based systems in the operational phase shall be recorded. The records shall contain information about the relevant software versions and other relevant information as described in [F.11.](#)

**Verification by BKI:**

Category I: No documentation requirements

Category II and III: See [F.12.](#)

## 3. Requirements on the System Supplier

### 3.1 Change management

**Requirement:**

The system supplier shall follow procedures for maintenance of the system including procedures for management of change as described in [E.3.2](#).

**Verification by BKI:**

Category I: No documentation requirements

Category II and III: See [F.12.](#)

### 3.2 Testing of changes before installation onboard

**Requirement:**

The system supplier shall make sure that the planned changes to a system have passed relevant in-house tests before the change is made to systems on board.

**Verification by BKI:**

Category I: No documentation requirements

Category II and III: See [F.12.](#)

## F. Management of change

### 1. General

[E.3.2](#) provides requirements for the management of change throughout the lifecycle of a computer-based system. Different procedures for the management of change may be defined for specific phases in a system's lifecycle as the different phases typically involve different stakeholders. BKI's verification is described in [F.12](#).

### 2. Documented change management procedures

**Requirement:**

The organization in question shall have defined and documented change management procedures applicable for the computer-based system in question covering both hardware and software. After FAT, the system supplier shall manage all changes to the system in accordance with the procedure. Examples could be qualification of new versions of acquired software, new hardware, modified control logic, changes to configurable parameters.

The procedure(s) shall at least describe the activities listed in [F.3](#). through [F.11.](#). The outcome of the impact analysis in [F.8](#). will determine to what extent the activities in [F.3](#). to [F.12](#). shall be performed. Change records (described in [F.11.](#)) shall always be produced.

### 3. Agreement between relevant stakeholders

**Requirement:**

The management of change process shall be coordinated and agreed between the relevant stakeholders along the different stages of the lifecycle of the computer-based system.

**Guidance:** Typically, the management of change address at least three different stages:

- 1) Development and internal verification before FAT; involving the system supplier and sub-suppliers.
- 2) From FAT to handover of the vessel to the owner; involving the system supplier, the systems integrator, BKI, and the owner.
- 3) In operation; involving the system supplier, service suppliers, the owner, and BKI

### 4. Approved software shall be under change management

**Requirement:**

If changes are required to a system after it has been approved by applicable stakeholders (typically the systems integrator and BKI at FAT) the modifications shall follow defined change management procedures.

### 5. Unique identification of system and software versions

**Requirement:**

The system supplier shall make sure that each system and software version is uniquely identifiable, see [D.2.2.](#)

### 6. Handling of software master files

**Requirement:**

There shall be defined mechanisms for handling of the files that constitutes the master-files for a software component. Personnel authorities shall be clearly defined along with the tools and mechanisms used to ensure the integrity of the master files.

### 7. Backup and restoration of onboard software

**Requirement:**

It shall be clearly defined how to perform backup and restoration of the software components of a computer-based system onboard the vessel.

### 8. Impact analysis before change is made

**Requirement:**

Before a change to the system is made, an impact analysis shall be performed in order to:

- determine the criticality of the change.
- Determine the criticality of the change.
- Determine the impact on existing documentation.
- Determine the needed verification and test activities.
- Determine the need to inform other stakeholders about the change.
- Determine the need to obtain approval from other stakeholders (e.g. BKI and or Owner) before the change is made.

## 9. Roll-back in case of failed software changes

### **Requirement:**

When maintenance includes installation of new versions of the software in the system, it shall be possible to perform a rollback of the software to the previous installed version with the purpose of returning the system to a known, stable state.

Roll-backs shall be documented and analysed to find and eliminate the root cause.

## 10. Verification and validation of system changes

### **Requirement:**

To the largest degree practically possible, modifications shall be verified before being installed onboard.

After installation, the modification(s) shall be verified onboard according to a documented verification program containing:

- Verification that the new functionalities and/or improvements have had the intended effect.
- Regression test to verify that the modification has not had any negative effects on functionality or capabilities that was not expected to be affected.

## 11. Change records

Changes to systems and software shall be documented in change records to allow for visibility and traceability of the changes. The change records shall contain at least the following items:

- The purpose for a change
- A description of the changes and modifications
- The main conclusions from the impact analysis (see [F.8.](#))
- The identity and version of any new system or software version(s) (see [F.5.](#))
- Test reports or tests summaries (see [F.10.](#))

Documentation of the changes to software may be recorded in the planned maintenance system (PMS), in a software registry or equivalent.

## 12. Verification of change management by BKI

### 12.1 In operation (vessel in service) phase

The verification by BKI regarding the management of change in operation is generally performed during the annual survey of the vessel. Procedures for management of change and relevant change records (see [F.11.](#)) shall be made available at the time of survey.

In the cases where the change requires approval from BKI up front, the relevant procedures and documentation for the change in question may be verified at that time.

### 12.2 During newbuilding

The verification of management of change in the newbuilding phase is divided into two; Procedures are verified as a part of the verification of the quality management system ([D.1.2](#)), while project specific implementation of the procedures are verified during FAT ([D.2.7](#)) and after FAT ([F.12.1](#))

## **G. Technical requirements on computer-based systems**

The paragraphs below contain technical requirements on computer-based systems. The compliance to these requirements shall be documented in the design documentation (see [D.2.3](#)) and verified through the verification activities described in this Section.

### **1. Reporting of system and software identification and version**

#### **1.1 System identification**

The system shall provide means to identify its name, version, identifier, and manufacturer. It is recommended that the system can automatically report the status of its software to a ship software logging system (SSLS) as specified in the international standard ISO 24060.

### **2. Data links**

#### **2.1 General requirements for category II and III systems**

Loss of a data link shall be specifically addressed in risk assessment analysis/FMEA. See [D.2.3](#).

- 1) A single failure in data link shall not cause loss of vessel- functions of category III. Any effect of such failures shall meet the principle of fail-to-safe for the vessel-function(s) being served.
- 2) For vessel-functions of category II and III, any loss of functionality in the remote control system shall be compensated for by local/manual means.
- 3) The data link shall have means to prevent or cope with excessive communication rates.
- 4) Data links shall be self-checking, detecting failures or performance issues on the link itself and data communication failures on nodes connected to the link
- 5) Detected failures shall initiate an alarm.

#### **2.2 Specific requirements for wireless data links**

- 1) Category III systems shall not use wireless data links unless specifically considered by BKI on the basis of an engineering analysis carried out in accordance with an International or National Standard acceptable to BKI.  
Other categories of systems may use wireless data links with the following requirements:
- 2) Recognised international wireless communication system protocols shall be employed, incorporating:
  - A) Message integrity. Fault prevention, detection, diagnosis, and correction so that the received message is not corrupted or altered when compared to the transmitted message.
  - B) Configuration and device authentication. Shall only permit connection of devices that are included in the system design.
  - C) Message encryption. Protection of the confidentiality and or criticality of the data content.
  - D) Security management. Protection of network assets, prevention of unauthorized access to network assets.
- 3) The internal wireless system within the vessel shall comply with the radio frequency and power level requirements of International Telecommunication Union and flag state requirements.
- 4) Consideration should be given to system operation in the event of port state and local regulations that pertain to the use of radio-frequency transmission prohibiting the operation of a wireless data communication link due to frequency and power level restrictions.
- 5) For wireless data communication equipment, tests during harbour and sea trials are to be conducted to demonstrate that radio-frequency transmission does not cause failure of any equipment and does not self-fail as a result of electromagnetic interference during expected operating conditions.

### 3. Verification of technical requirements by BKI

The implementation of the technical requirements provided in [E.3.2](#) is verified by BKI as part of the system description ([D.2.3](#)), FAT ([D.2.7](#)) and SAT ([D.3.6](#)) described above.

## Section 11 Lighting and Socket-Outlets

A.	General . . . . .	11-1
B.	Lighting Installations . . . . .	11-1
C.	Socket-Outlets . . . . .	11-2

### A. General

1. The design and construction of lighting systems and socket-outlets are also required to conform to the Sections listed below:

- 3.C, Emergency lighting
- 4.H. and I, Power supply, final sub circuits, navigation lanterns and signalling lanterns
- 20.H, Construction of socket-outlets
- 20.I, Construction of lighting fixtures

2. The use of lighting fixtures and socket-outlets currently employed on shore is permitted in accommodation spaces, day rooms and service rooms. They shall, however, conform to 20.H or I., as appropriate.

### B. Lighting Installations

#### 1. Lighting Installations

1.1 A sufficient number of lighting fixtures shall be provided to achieve a good level of illumination.

1.2 A main lighting system shall be installed which is supplied from the main electrical power source and illuminates all areas accessible to the passengers and crew.

1.3 The arrangement of the main and emergency lighting systems (sources of electrical power, associated transformers, switchboards and central lighting distribution panels) shall be such that a fire or other incident does not cause the failure of both systems, i.e. the aforementioned components of the main and emergency lighting systems shall not be located in the same rooms.

1.4 Following a failure of the main power supply, the emergency lighting system shall cut in automatically. Local switches may be provided only where the ability to switch off the emergency lighting is required, e.g. in the wheelhouse.

1.5 Ro-Ro Passenger ships shall be provided with an additional emergency lighting system, see Section 16.F.

1.6 Emergency lighting fixtures shall be marked as such for easy identification.

1.7 Where, in accordance with SOLAS, a ship is divided into main fire zones, at least two circuits shall be provided for the lighting of each main fire zone, and each of these shall have its own power supply circuit. One circuit can be supplied from the emergency switchboard, if this is permanently in service. The supply circuits shall be routed in such a way that a fire in one main fire zone does not interfere with the lighting of the other zones.

### 1.8 Cargo holds, bunkers and pipe tunnels

For a permanently installed lighting system, switches with clearly marked positions or indicating lights shall be provided for each final sub circuit or for each area.

The lighting fixtures shall be provided with unbreakable covers and so mounted that they cannot be damaged when work is being carried out.

Lighting fixtures in cargo holds shall be installed in such a way that, when properly used, there is no overheating of the lighting fixtures or their surroundings, even when the ship is loaded.

### 1.9 Illumination for pilot transfer

Adequate illumination shall be provided for the out-board transfer arrangements, the deck region where persons come on board or leave and at the control positions for the mechanical pilot hoist.

## 2. Mounting of lighting fixtures

2.1 The lighting fixtures on the open deck which are used while the ship is travelling, shall be so located that they do not impede the navigation. If necessary, they shall be fitted with reflectors.

2.2 Within arm's reach of showers and bathtubs up to 1,2 metres from the shower head and/or 0,6 metre from the tub rim vertical surface and up to a height of 2,25 metres, lighting fixtures shall only be installed if their degree of protection is at least IP 55.

Switches shall not be installed within arm's reach.

2.3 For lighting fixtures mounted in corridors, the head clearance shall be at least 1,80 metres.

2.4 All lighting fixtures shall be so mounted that combustible parts are not ignited by the generated heat, and they themselves are not exposed to damage.

All lighting fixtures shall be so mounted that combustible parts are not ignited by the generated heat, and they themselves are not exposed to damage.

Where no minimum distances are specified, the minimum distances in the direction of radiation indicated in [Table 11.1](#) shall be applied for lighting fixtures in accordance with IEC publication 60598-1 Luminaires, Part 1: General Requirements and Tests.

**Table 11.1: Minimum distances for the mounting of lighting fixtures**

Rated power [W]			Minimum distance [m]
	up to and incl.	100	0,5
over 100	up to and incl.	300	0,8
over 300	up to and incl.	500	1,0

## C. Socket-Outlets

### 1. General

1.1 The supply for socket-outlets in the accommodation, day rooms and service rooms (250 V) are to be run from lighting distribution panels. The maximum fuse rating for a circuit is 16 A.

1.2 For the sockets of distribution systems with different voltages and/or frequencies, non-interchangeable plugs and socket-outlets shall be used.

1.3 Plug-in connections shall not be installed below the floor in engine rooms or boiler rooms.

1.4 Socket outlets for power circuits over 16 A AC or 10 A DC shall be interlocked in such a way that the plug can be neither inserted nor withdrawn when the socket contacts are live.



## 2. Shower rooms and bathing rooms

2.1 In shower rooms and bathing rooms the electrical equipment shall be installed in accordance with IEC publication 60364-7-701.

2.2 The minimum degree of protection against foreign bodies and water shall be according to [Table 11.2](#).

**Table 11.2: Minimum degree of protection against foreign bodies and water in zone 0, 1 and 2**

Zone	Degree of protection of the needed electrical equipment in shower rooms and bathing rooms
0	IP X7
1	IP 55
2	IP 34

## 3. Cargo holds

Sockets in cargo holds shall be installed only in locations with sufficient protection against mechanical damage.

## 4. Container connections

4.1 Socket connections for refrigerated containers shall be supplied from own sub distribution panels. At the sub distribution panels shall be indicated whether these distribution panels are live and which supply circuit is switched on.

4.2 Several socket-outlets may be grouped together for common supply via one power cable, provided that the individual connections are protected at site against overcurrent and short-circuit, and the supply cable is rated for the total power demand. For details, see [Section 12.C](#).

*This page intentionally left blank*

## Section 12 Cable Network

A.	Choice of Cables and Wires . . . . .	12-1
B.	Determination of Conductor Cross-Sections . . . . .	12-2
C.	Rating, Protection and Installation of Circuits . . . . .	12-5
D.	Installation . . . . .	12-7
E.	Requirements for Busbar Trunking Systems Intended for the Electrical Supply of Distribution Panels and Single Consumers . . . . .	12-15

### A. Choice of Cables and Wires

#### 1. General instructions

Cables and conductors shall conform to the requirements stated in [Section 20.F](#).

#### 2. Rated voltage

The rated voltage of a cable shall be not less than the operating voltage of the relevant circuit.

In insulated distribution systems, the outer conductor voltage of the system shall be deemed to be the rated voltage of the cable between a conductor and the ship's hull.

#### 3. Temperatures

At places where higher ambient temperatures are expected, cables shall be used whose permissible temperature is at least 10 K above the maximum anticipated ambient temperature.

A correction of the permissible current rating shall be made in accordance with [Table 12.1](#).

Cables on diesel engines, turbines, boilers etc., where there is danger of excessive heating, shall be so routed that they are protected against inadmissible external heating stress, or cables are to be used which are approved for the maximum arising ambient temperature.

#### 4. Mechanical protection

The choice of cables shall consider the mechanical stressing, see [D](#).

**Table 12.1: Corrective factors for rating capacity of conductor cross-sectional areas**

Permissible operating temperature		Ambient temperature [°C]										
		35	40	45	50	55	60	65	70	75	80	85
[°C]	Table	Correction factor										
60	12.6	1,29	1,15	1,0	0,82	-	-	-	-	-	-	-
75	12.6	1,15	1,08	1,0	0,91	0,82	0,71	0,58	-	-	-	-
80	12.7	1,13	1,07	1,0	0,93	0,85	0,76	0,65	0,53	-	-	-
85	12.7, 12.8	1,12	1,06	1,0	0,94	0,87	0,79	0,71	0,61	0,50	-	-
90	12.9	1,10	1,05	1,0	0,94	0,88	0,82	0,74	0,67	0,58	0,47	-
95	12.9	1,10	1,05	1,0	0,95	0,89	0,84	0,77	0,71	0,63	0,55	0,45

**5. Mobility**

5.1 Machines or equipment mounted on vibration absorbers (rubber or springs) shall be connected with cables or wires of sufficient flexibility and installed with compensating bends.

5.2 Mobile equipment shall be connected via flexible cables, e.g. of type HO7RN-F, CENELEC HD 22 or equivalent.

For voltages above 50 V, flexible connecting cables or wires intended for equipment without double insulation shall also include an earthing conductor.

The earthing conductor shall have a green/yellow coloured marking.

5.3 For mobile parts of installations or lifting wheelhouses supplied via scissor-type cable supports, suspended loops, festoon systems etc., the use of suitable, flexible cables is required.

**6. Application of cables and wires**

Cables and wires shall be used according to the application categories, [Table 12.2](#).

**Table 12.2: Application categories for power, control and communication cables**

Category	Range of application	Remarks
1	Within the ship in all areas and on open deck	Cables with shielding and outer sheath
2	Within the ship in all areas, except where EMC requirements exist and not in hazardous areas	Cables without shielding
3	Only in crew and passenger accommodation/day rooms, for final supply circuits of lighting, sockets and space heating	Cables without shielding, with single-wire (solid) conduction up to 4 mm <sup>2</sup>
4	At diesel engines, turbines, boilers and other devices with higher temperatures	Heat-resistant cables (wires)
5	Other application areas, not specified in 1- 4	See type test Certificate

**B. Determination of Conductor Cross-Sections**

**1. Rating method on the basis of maximum current-carrying capacity**

Conductor cross-sections are to be determined on the basis of load with due regard for [C.1.- C.3](#).

The calculated current shall be equal to, or smaller than, the permissible current for the chosen conductor cross-section.

The permissible current-carrying capacities of cables listed in [Table 12.6 - Table 12.9](#) apply to an ambient temperature of 45 °C and to the stated permissible operating temperature of the cables or wires.

1.1 The current-carrying capacities listed in [Table 12.6 - Table 12.9](#) apply to flat cable configurations containing not more than 6 cables laid side by side, or to groupings of not more than 3 cables or insulated wires, as follows:

Flat arrangement:



Groupings of not more than 3 cables:



The triple groups shall be laid in each direction with a spacing corresponding to at least one outer diameter of the largest cable or largest insulated wire.

**1.2** If the specified configurations cannot be adhered to, or the passage of cooling air is not assured, the current-carrying capacity shall be reduced to 85 % of the values given in the tables, and the overcurrent protection shall be modified accordingly.

Exceptions are made for bundles of cables and insulated wires which are not part of the same circuit and/or which will not be loaded with their rated currents simultaneously.

**1.3** For the laying of single-core cables and wires in single-phase and three-phase alternating current systems, see [D.7](#).

**1.4** Cables whose maximum permissible conductor temperatures differ from each other by more than 5 K may be bundled together only if the permissible current-carrying capacity of the lowest-capacity type is taken as the rating-basis for all cables.

**1.5** Parallel cables are permitted only with conductor cross-sections of 10 mm<sup>2</sup> (AWG 7) and over.

Only cables of the same length and having the same conductor cross-section may be installed as parallel cables. Equal current-distribution shall be ensured.

Parallel cables may be loaded to the sum of their individual current-carrying capacities and shall be common fused.

## **2. Rating on the basis of voltage drop**

**2.1** Under normal service conditions, the voltage drop between the busbars (main/emergency switchboard) and the consumers shall not exceed 6 %, or 10 % in the case of battery-supplied networks of 50 V or less. Navigation lights are subject to the requirements of [Section 4.1.6](#).

**2.2** Where short-term peak loads are possible, for instance due to starting processes, it is to ensure that the voltage drop in the cable does not cause malfunctions.

## **3. Consideration of current peaks**

The cross-section shall be so chosen that the conductor temperatures do not exceed the maximum limits specified below neither under short-circuit nor start-up conditions:

for PVC	(60 °C) 150 °C
for PVC	(75 °C) 150 °C
for EPR	(85 °C) 200 °C
(EPM or EPDM)	
for XLPE (VPE)	(85 °C) 250 °C
for silicone (95 °C)	according to specification

The figures in brackets are the permissible operating temperatures at the conductor in continuous operation.

## **4. Minimum cross-sectional areas and their current-carrying capacity**

**4.1** The conductor cross-sections indicated in [Table 12.3](#) are the minimum cross-sections for external cabling respective for internal wiring, e.g. of switchgear and consoles.

4.2 The maximum current-carrying capacity of conductor cross-sections for external cabling is indicated in Table 12.6 - Table 12.9. For cables and wires in telecommunications systems apply the values listed in Table 12.4.

A maximum permissible current of 1,0 A is applicable to the 0,2 mm<sup>2</sup> (AWG 24) conductor cross-section regardless of the number of cores.

Table 12.3: Minimum cross-sectional areas

	Nominal cross-section			
	external wiring		internal wiring	
	International	AWG	International	AWG
Power, heating and lighting systems	1,0 mm <sup>2</sup>	17	1,0 mm <sup>2</sup>	17
Control circuits for power plants	1,0 mm <sup>2</sup>	17	1,0 mm <sup>2</sup>	17
Control circuits in general, safety systems in accordance with Section 9	0,75 mm <sup>2</sup>	18	0,5 mm <sup>2</sup>	20
Telecommunications equipment in general, automation equipment	0,5 mm <sup>2</sup>	20	1,0 mm <sup>2</sup>	28
Telephone and bell installations, not relevant for the safety of the ship or crew call installations	0,2 mm <sup>2</sup>	24	1,0 mm <sup>2</sup>	28
Data bus and data cables	0,2 mm <sup>2</sup>	24	1,0 mm <sup>2</sup>	28

Table 12.4: Rating of telecommunication and control cables

Number of core pairs [2 cores]	Number of cores	Nominal cross-section 0,5 mm <sup>2</sup> (AWG 20)		Nominal cross-section 0,75 mm <sup>2</sup> (AWG 18)	
		Permissible load	Rated fuse current	Permissible load	Fuse rating
		A max.	A	A max.	A
1 x 2	2	-	-	10,5	10
2 x 2	4	5	6	7,5	6
4 x 2	8	4	4	6	6
7 x 2	14	3,5	4	4,5	4
10 x 2	20	3	4	4	4
14 x 2	28	3	2	3,5	4
19 x 2	38	3	2	3,5	4
24 x 2	48	2	2	3	2
48 x 2	96	2	2	-	-

The values in the Table relate to an ambient temperature of 45 °C and a conductor temperature of 85 °C.

4.3 In accommodation and day rooms, flexible cables with a conductor cross-section of not less than 0,75 mm<sup>2</sup> (AWG 18) may also be used for the connection of movable equipment with a current consumption of up to 6 A.

4.4 For ship's hull return, see Section 1.G.3. and Section 4.I.1.2.

4.5 For earthing conductors, see Section 1.K.

4.6 Neutral conductors in three-phase distribution systems shall be in cross-section equal to at least half the cross-section of the outer conductors. If the outer conductor cross-section is 16 mm<sup>2</sup> (AWG 5) or less, the cross-section of the neutral conductor shall be the same as that of the outer conductors.

4.7 Exciter equalizer cables for three-phase generators in parallel operation shall be rated for half the nominal exciter current of the largest generator.

## C. Rating, Protection and Installation of Circuits

### 1. Individual consumers and rating of final sub circuits

1.1 Cables shall be rated according to the expected operating load based on the connected load and the mode of operation of the consumers. The values shown on the name plate of a consumer are valid.

1.2 The following loads are to be assumed for 250 V AC lighting circuits and socket-outlet circuits:

- for each lighting point, at least 100 W
- for each socket-outlet, at least 200 W

### 2. Consideration of a diversity factor for group supply cables

2.1 If all the connected consumers in a part of the system are not simultaneously in operation, a diversity factor may be used for determining the cross-section.

A diversity factor is the ratio of the highest operating load expected under normal operating conditions to the sum of the rated loads of all the connected consumers.

2.2 The load ascertained by the application of a diversity factor shall be deemed to be the continuous load for the determination of the cross-section.

2.3 The diversity factors shown in [Table 12.5](#) may be applied to the rating of cables used to supply groups of winches.

The values given in the [Table 12.5](#) shall be related to the rated motor current, or, in the case of motors with several different outputs, to the current corresponding to the highest output.

2.4 Group supply feeders for hydraulic winches shall be rated for the installed power without the application of a diversity factor.

2.5 The cross-section of group supply feeders for cargo cranes shall be determined in the same way as for cargo winches.

2.6 For cargo cranes with one drive motor, the supply cable shall be rated according to the current rating of the maximum load capacity.

2.7 Where cargo cranes have more than one motor, the feeder cable to an individual crane can be rated as follows:

The value of the current used for cross-section determination shall be equal to 100 % of the output of the lifting motors plus 50 % of the output of all the other motors. With this calculated current, the cross-section of the cable shall be selected for continuous operation.

2.8 If current diagrams for the various operating conditions of cranes or groups of winches have been ascertained, the average current based on the diagram may be used instead of application of a diversity factor.

2.9 Cross-sections of group supply feeders for refrigerated container socket-outlets are to be designed in accordance with power calculation considering the corresponding diversity factor (see [Section 3.B.](#)).

**Table 12.5: Diversity factors during operation with winches**

Number of winches	The following values shall be used for determining the cable cross-section	
	Winches with DC motors	Winches with induction motors
2	100 % of the largest motor + 30 % of the second motor, or, with identical motors, 65 % of their combined full current	100 % of the largest motor + 50 % of the second motor, or, with identical motors 75 % of their combined full load current
3	100 % of the largest motor + 25 % of the remaining motors, or, with identical motors 50 % of their combined full current	100 % of the largest motor + 50 % of the remaining motors, or, with identical motors 67% of their combined full current
4	100 % of the largest motor + 20 % of the remaining motors, or, with identical motors 40 % of their combined full current	100 % of the largest motor + 50 % of the remaining motors, or, with identical motors 62 % of their combined full current
5	100 % of the largest motor + 20 % of the remaining motors, or, with identical motors 36 % of their combined full current	100 % of the largest motor + 50 % of the remaining motors, or, with identical motors 60 % of their combined full current
6 and more	33 % of the combined full load current	58 % of the combined full load current

### 3. Cables overload protection

3.1 Cables shall be protected against short-circuit and overcurrent.

3.2 Rating and setting of the protection devices shall be in compliance with the requirements in [Section 4.](#)

3.3 Cables protected against overcurrent at the consumers side require only short-circuit protection at the supply side.

For steering gear, see [Section 7.A.](#)

3.4 Exciter cables for DC motors and DC generators operating in parallel shall not be fused.

Exciter cables for individually connected DC generators and synchronous three-phase alternators shall be fused only if there are special reasons for it, e.g. where the cables are passing through various compartments of the ship.

### 4. Separation of circuits

4.1 A separate cable shall normally be provided for each circuit having its own overcurrent and shortcircuit protection. Deviating from this requirement the following may be combined in a common cable:

- a main circuit and its control circuits which have their tapping off after the main switch
- various control circuits laid separately from the main circuits
- various main circuits and their control circuits belonging to a common system, e.g. for several drives of an air-conditioning system, if all the cores of the cable can be centrally disconnected from the supply

4.2 Separate cables shall be provided for safety voltage circuits.

4.3 Separate cables shall be provided for intrinsically safe circuits.

### 5. Cable laying for circuits

5.1 For single-phase and three-phase AC systems, multi-core cables are to be used wherever possible.



5.2 Should it be necessary to lay single-core cables for the carriage of more than 10 A in single-phase or three-phase AC circuits, the special requirements of D.7. shall be fulfilled.

5.3 In three-phase systems without hull return, three-core cables shall be used for three-phase connections; four-core cables are required for circuits with loaded neutral point.

5.4 In three-phase systems with hull return the asymmetry of the currents in the three conductors of three-core cables shall not exceed 20 A (see Section 4.1).

5.5 In DC systems without hull return multi-core cables shall be provided in all cases of smaller crosssections.

Where single-core cables are used for large cross-sections, the outgoing and return-cables shall be laid as close as possible to each other over their entire length to avoid magnetic stray fields.

5.6 The generator cables, all cables run from the main or emergency switchboard or an auxiliary switch-board, and all interconnecting cables for essential equipment, shall be laid as far as possible uninterrupted in length to the distribution panels or to the equipment.

5.7 The cables of intrinsically safe circuits shall be laid at a distance of at least 50 mm separated from the cables of non-intrinsically safe circuits. The laying of intrinsically safe circuits together with non-intrinsically safe circuits in a pipe is not permitted.

Cables of intrinsically safe circuits shall be marked.

## D. Installation

### 1. Routing of cables

1.1 The routes of cables shall be such that cables are laid as straight as possible and are not exposed to mechanical damage.

1.2 For bends, the minimum bending radius permitted by the manufacturer shall be observed. The radius shall be not smaller than 6 times of the outer diameters of the cables.

1.3 Heat sources such as boilers, hot pipes etc. shall be bypassed, so that the cables are not subjected to additional heating. If this is not possible, the cables are to be shielded from thermal radiation.

1.4 The tensile stress of the cables at long cable runs caused by thermal expansion and/or movement of ship structure shall not damage the cables, cable runs or cable penetration systems.

At long and straight cable runs like in passage ways or void spaces etc. or at other positions where unacceptable tensile stresses are liable to occur at the cables and cable trays, precautions shall be taken to distribute the expansion movement uniformly over a cable loop provided for such purpose, so that there is no damaging of the cables, cable runs or cable penetration systems.

The diameter of the cable loop shall be at least 12 times the diameter of the thickest cable. In each division should be provided at least one cable loop.

1.5 Cables shall not be laid within room isolations. Exceptions are permitted for lighting, socket-outlets and control circuits in accommodation and refrigerated rooms, provided that the maximum loading of the cables does not exceed 70 % of their current carrying capacity.

1.6 Where, for safety reasons, a system shall have duplicated supply and/or control cables, the cable routes are to be placed as far apart as possible.

1.7 Supply cables for emergency consumers shall not be run through fire zones containing the main source of electrical power and associated facilities. Exceptions are made for cables for supply of emergency consumers located within such areas.

1.8 The electrical cables to the emergency fire pump shall not pass through the machinery spaces containing the main fire pumps and their sources of power and prime movers. If the electrical cables to the emergency fire pump pass through other high fire risk areas, they are to be of a fire-resistant type.

**1.9** Cables for supply of essential equipment and emergency consumers, e.g. lighting and important communications and signalling systems shall, wherever possible, bypass galleys, laundries, category A engine rooms and their casings and areas with a high fire risk.

On ships whose construction or small size precludes fulfilment of these requirements, measures shall be taken to ensure the effective protection of these cables where they have to be run through the rooms mentioned above, e.g. by the use of fire-resistant cables or by flame-retardant coating such an installation shall be approved by BKI.

**1.10** Cable installation for medium-voltage equipment [Section 8.E](#). is to be observed.

## **2. Fastening of cables and wires**

**2.1** Cable trays and cableways shall be made preferably of metallic materials which are protected against corrosion.

Cables and wires shall be fastened with corrosion-resistant, flame retardant clips or bindings. Exceptions are made for cables which are laid in pipes or cable ducts.

Cables and wiring shall be installed and supported in such a manner as to avoid chafing or other damage.

This also applies for the installation of cables and wires in connection boxes of electrical equipment and switchboards.

**2.2** Suitable materials shall be placed together when fasten cables to aluminium walls.

Clips for mineral-insulated cables with copper sheaths shall be made of copper alloy if they are in electrical contact with the latter.

**2.3** Single-core cables are to be fastened in such a manner that they are able to withstand the electrodynamic forces occurring in the event of short-circuits.

**2.4** The distances between the supports for cable racks and the fastenings used shall be selected with due regard to the cable type, cross-section and number of cables concerned.

**2.5** Where cables suspended are fastened by the use of plastic clips or straps, metallic cable fixing devices, spaced not more than 1 meter apart shall be used additionally in the following areas:

- generally, in escape routes and emergency exits, on the open deck, in refrigeration rooms and in boiler rooms
- cargo holds, machinery rooms, control rooms and service rooms where bunched cables are fastened on riser cable trays or under the cable trays

**2.6** Cable trays/protective casings made of plastic materials shall be tightened in such a way that they do not obstruct together with the cables the escape routes in case of fire, see [6.2](#).

The suitability of cable trays shall be proved, see [Section 21.E.5.1.1 d](#)). Installation, see also [2.5](#).

**2.7** It is recommended, that cables and cable bunches shall not be painted.

If they still would be painted the following shall be observed:

- the paint shall be compatible with the material of the cables, and
- the flame-retardant property respectively fire resistance of the cables and cable bunches shall be maintained.

## **3. Stress relief**

Cables shall be so installed that any tensile stresses which may occur remain within the permitted limits. This shall be particularly observed for cables on vertical runs or in vertical conduits.

#### 4. Protection against mechanical damage

4.1 Cables in cargo holds, on open decks and at positions where they are exposed to a particularly high risk of mechanical damage shall be protected by pipes, covers or closed cable ducts.

4.2 Cables in cargo holds, on open decks and at positions where they are exposed to a particularly high risk of mechanical damage shall be protected by pipes, covers or closed cable ducts.

#### 5. Installation of cables and wires in metallic pipes, conduits or closed metal ducts

5.1 If cables are installed in pipes or ducts, attention shall be paid that the heat from the cables can be dissipated into the environment.

5.2 The inside of the pipes or ducts shall be smooth, and their ends shaped in such a way as to avoid damage to the cable sheath.

They shall be effectively protected inside against corrosion. The accumulation of condensation water shall be avoided.

5.3 The clear width and any bends shall be such that the cables can be drawn through without difficulty. The bending radius of the pipe shall be equivalent to at least 9 times of the outer cable diameter.

5.4 Where pipes or ducts passing through areas where panting is expected, suitable means of compensation shall be provided.

5.5 Not more than 40 % of the clear cross-section of pipes and ducts shall be filled with cables. The total cross-section of the cables is deemed to be the sum of their individual cross-sections based on their outside diameters.

5.6 Pipes and ducts shall be earthed.

5.7 Single-core cables of single and three phase AC systems shall be provided with plastic outer sheaths if they are installed in metallic pipes or ducts.

5.8 Long cable ducts and pipes shall be provided with a sufficient number of inspection and pull boxes.

#### 6. Installation in non-metallic pipes and ducts

6.1 Cable trays/protective casings made of plastic materials are to be type tested in accordance with IACS UR E 16, see [Section 21.E.5.1.1 d](#)).

**Note:**

*"Plastics" means both thermoplastic and thermosetting plastic materials with or without reinforcement, such as polyvinyl chloride (PVC) and fibre reinforced plastics (FRP).*

*"Protective casing" means a closed cover in the form of a pipe or other closed ducts of non-circular shape.*

*Applicable for pipes with a diameter of more than 80 mm.*

6.2 Non-metallic pipes or cable ducts shall be made of flame-retardant material.

Additional requirements for passenger vessels in [Section 14.F.2.1](#) are to be observed.

6.3 Cable trays/protective casings made of plastic materials are to be supplemented by metallic fixing and straps such that in the event of a fire they, and the cables affixed, spaced not more than 1 meter apart are prevented from falling and causing an injury to personnel and/or an obstruction to any escape route.

**Note:**

*When plastic cable trays/protective casings are used on open deck, they are additionally to be protected against UV light.*

6.4 The load on the cable trays/protective casings is to be within the Safe Working Load (SWL). The support spacing is not to be greater than the Manufacturer's recommendation nor in excess of spacing at the SWL test. In general, the spacing is not to exceed 1 meter.

**Note:**

*The selection and spacing of cable tray/protective casing supports are to take into account:*

- *cable trays/protective casings' dimensions*
- *mechanical and physical properties of their material*
- *mass of cable trays/protective casings*
- *loads due to weight of cables, external forces, thrust forces and vibrations*
- *maximum accelerations to which the system may be subjected*
- *combination of loads*

6.5 The sum of the cables' total cross-sectional area, based on the cables' external diameter, is not to exceed 40 % of the protective casing's internal cross-sectional area. This does not apply to a single cable in a protective casing.

**7. Laying of single-core cables and wires in single-phase and three-phase AC systems**

In cases where use of multi-core cables is not possible, single-core cables and wires may be permitted for installation if the following provisions are made and the requirements of IEC 60092-352 are observed:

7.1 The cables shall not be armoured or shrouded with magnetic material.

7.2 All conductors belonging to one circuit shall be run together in the same pipe or duct, or clamped by common clamps, unless the clamps are made of non-magnetic materials.

7.3 The cables forming a circuit shall be laid immediately beside of each other and preferably in triangular configuration. If spacing's cannot be avoided, the spacing's shall not exceed one cable diameter.



7.4 No magnetic material shall be placed between single-core cables passing through steel walls. No magnetic materials shall be between the cables of deck and bulkhead penetrations. Care shall be taken to ensure that the distance between the cables and the steel wall is at least 75 mm, unless the cables belonging to the same AC circuit are installed in trefoil formation, see 7.3.

For the installation of single core parallel cables between the cable groups these measures are not necessary, if the cable groups are arranged in trefoil formation.



7.5 Single-core parallel cables shall be of the same length and cross-section. Furthermore, to avoid unequal division of the current, the cables of one phase shall be laid, as far as is practicable, alternatively with the cables of the other phases, e.g. in the case of two cables for each phase:

L1, L2, L3, L3, L2, L1	or	L1, L2, L3
		L3, L2, L1
or L3, L1, L2	or	L2, L3, L1
L2, L1, L3		L1, L3, L2

7.6 To balance the impedance of the circuit in single-core cables more than 30 meters long and with a cable cross-section of more than 150 mm<sup>2</sup>, the phases are to be alternated at intervals of not more than 15 meters.

7.7 For single-core cables, metallic sheaths are to be insulated from each other and from the ship's hull over their entire length. They shall be earthed at one end only, except earthing is required at both ends for technical reasons (e.g. for medium voltage cables). In such cases the cables shall be laid over their entire length in triangular configuration.

## 8. Bulkhead and deck penetrations

8.1 Cable penetrations shall conform to the partition categories laid down by SOLAS and shall not impair the mechanical strength or water tightness of the bulkhead.

8.2 Bulkhead and deck penetrations shall have been type-tested by BKI. [The Guidance for Approval and Type Approval of Materials and Equipment for Marine Use \(Pt.1, Vol.W\) Sec.3.AJ](#) is to be taken into consideration.

8.3 The cables shall not occupy more than 40 % of the cross-section of a penetration.

8.4 Vertical cable ducts shall be so constructed that a fire on one deck cannot spread through the duct to the next higher or lower deck (see also [14.2.2](#)).

## 9. Cables in the vicinity of radio-communication and navigation equipment

9.1 Except where laid in metallic pipes or ducts, cables and wires with metal sheaths or metal braiding are to be used above the uppermost metallic deck and in positions where the cables and wires are not separated by metallic bulkheads or decks from aerials, aerial downloads, the radio room, direction finder or other radio navigation or receiving equipment. The metallic sheaths and shields are to be earthed.

9.2 Only cables required in the radio room shall be laid there. If cables without a braid shielding have to be run through a radio room, they shall be installed in a continuous metallic pipe or duct which is earthed at the entrance to and exit from the room.

9.3 Single-core cables are not permitted in the radio room.

9.4 If the radio equipment is installed on the bridge, the requirements stated above are to be complied with as and where applicable.

## 10. Magnetic compass zone

All electrical cables, wires, machines and apparatuses shall be laid, installed or magnetically shielded in order to avoid inadmissible interference (deviation < 0,5 degree) with the magnetic compass.

## 11. Cable installation in refrigeration spaces

11.1 Only cables with outer sheaths resistant to corrosion and cold-resistant shall be laid in refrigerated rooms.

11.2 Where cables are led through the thermal isolation, 1,5 shall be observed.

**11.3** Only cables without hull return are permitted in refrigerated rooms and in the associated air cooler spaces. The earthing conductors shall be run together with the other cables from the relevant distribution panel.

## **12. Earthing of the braided screens of cable network and accessories**

**12.1** Metallic cable sheaths, armouring and shields in power installations shall be electrically connected to the ship's hull at each end; single-core cables shall be earthed at one end only. For cables and wires for electronic equipment, the manufacturer's recommendations shall be observed, earthing at one end only is recommended.

**12.2** Electrical continuity of all metallic cable coverings shall also be maintained inside of cable junction and connection boxes.

**12.3** Metallic cable sheaths, armouring and shields shall be earthed, preferably by the use of standard cable gland fittings designed for that purpose, or by suitable equivalent clips or joints.

**12.4** Metallic cable sheaths, armouring's and shields shall in no case be deemed to constitute earthing conductors for the protective earthing of the connected electrical equipment.

## **13. Cable joints and branches**

**13.1** Cables shall be extended only with the approval of BKI. The used material shall maintain the flame-retardant and where required the fire-resistant properties of the cables.

**13.2** Junction and distribution boxes shall be accessible and marked for identification.

**13.3** Cables for safety low voltage shall not pass a junction or distribution box together with cables for higher voltage systems.

**13.4** The terminals for different types of systems, especially such of differently operating voltages, shall be separated.

## **14. Measures for limitation of the propagation of fire along cable and wire bundles**

**14.1** All cables shall be so installed that the original flame-retardant properties of the individual cables are not impaired. This requirement can be considered to be fulfilled if:

- the bundled cables are individually flame-retardant and have been successfully passed the bundle fire test in accordance with IEC 60332-3-22:2018 category A
- suitable measures have been taken during the installation, e.g. by providing of fire stops or application of flameproof coatings

**14.2** For cable bundles consisting of cables which have not been subjected to a bundle fire test, the following precautions shall be taken to limit the fire propagation:

**14.2.1** Fire stops shall be provided:

- at main and emergency switchboards
- at cable entries to engine control rooms
- at central control panels and consoles for the main propulsion plant and for important auxiliaries

**14.2.2** In closed and semi-enclosed rooms, fire stops shall be provided at the following locations:

- at each entry and exit point of cable runs in enclosed metallic installation shafts
- for open vertical cable runs, at least for every second deck, limited to a maximum interval of 6 meters
- every 14 meters for open horizontal cable runs

### 14.3 Exceptions

Fire stops in accordance with [14.2.1 a\)](#) and [c\)](#) can be omitted if the switchboards or consoles are installed in separate rooms and measures have already been taken at the cable entrances to these rooms, in cargo holds and in under-deck service passageways in the cargo zone. Fire stops shall be provided only for the boundaries of these rooms.

### 14.4 Version of fire stops

The flame propagation of cables passing through fire stops shall fulfil the SOLAS requirements for B-O partitions.

Fire stops may, for example, be formed by existing partitions or by a steel plate (minimum 3 mm in thickness) together with a B-O penetration in each case.

The steel plate shall be so formed that it extends around the cables as specified below:

- twice the maximum dimension of the cable run with vertically laid cables
- the maximum dimension of the cable run with horizontally laid cables

The steel plates, however, need not to be extended through upper covers, decks, bulkheads or trunk walls.

### 14.5 Application of flameproof coatings

Instead of the fire stops prescribed in [14.4](#), installed cable bundles may be provided with (BKI type approved) flameproof coatings as follows:

- on horizontal cable runs for every 14 meters, a length of 1 meter
- on vertical cable runs over the entire length

Other distances for the coatings may be approved after special testing.

### 14.6 Alternative methods

Other methods which have been proved to be equivalent to the measures stated in [14.4](#) and [14.5](#) may be accepted.

### 14.7 Explanatory sketches

Explanatory notes to the installation provisions described above are given in [Fig. 12.1](#) - [Fig. 12.4](#).

**14.8** See also [Guidance for Codes and Convention Interpretations \(Pt.1, Vol.Y\) Sec.11.SC10](#)

## 15. Application of fire-resistant cables

### 15.1 Scope of installations

**15.1.1** Where cables specified in [Section 20.F.1.3](#) for services (see [15.1.3](#)) including their power supplies pass through high fire risk areas, and in addition for passenger ships, main vertical fire zones, other than those which they serve, they are to be so arranged that a fire in any of these areas or zones does not affect the operation of the service in any other area or zone. This may be achieved by either of the following measures:

- 1) Cables being of a fire-resistant type complying with IEC 60331-1:2018, for cables of greater than 20 mm overall diameter, otherwise IEC 60331-21:1999+AMD1:2009 or IEC 60331-2:2018 for cables with an overall diameter not exceeding 20 mm, are installed and run continuous to keep the fire integrity within the high fire risk area, see [Fig. 12.5](#).
- 2) At least two-loops/radial distributions run as widely apart as is practicable and so arranged that in the event of damage by fire at least one of the loops/radial distributions remains operational.

**15.1.2** Systems that are self-monitoring, fail safe or duplicated with cable runs as widely separated as is practicable may be exempted provided their functionality can be maintained.

**Notes**

a) The definition for "high fire risk areas" is the following:

- Machinery spaces as defined in Regulation 3.30 of SOLAS Chapter II-2, as amended by IMO resolutions up to MSC.421(98) (hereinafter the same) except spaces having little or no fire risk as defined by paragraphs (10) of Regulation 9.2.2.3.2.2 of SOLAS Chapter II-2 (Including the interpretations for tables 9.3, 9.4, 9.5, 9.6, 9.7 and 9.8 given in MSC/Circ.1120 as amended by MSC.1/Circ.1436 and MSC.1/Circ.1510)
- Spaces containing fuel treatment equipment and other highly flammable substances
- Galley and Pantries containing cooking appliances
- Laundry containing drying equipment
- Spaces as defined in paragraphs (8), (12), and (14) of Regulation 9.2.2.3.2.2 of SOLAS Chapter II-2 for ships carrying more than 36 passengers.

b) Fire resistant type cables shall be easily distinguishable.

c) For special cables, requirements in the following standards may be used:

*IEC 60331-23:1999: Procedures and requirements – Electric data cables as amended*

*IEC 60331-25: 1999: Procedures and requirements – Optical fibre cables as amended*

**15.1.3** Emergency services required to be operable under fire conditions on the cables include:

- fire and general alarm system
- fire extinguishing systems and fire extinguishing medium alarms
- fire detection system
- control and power systems to power operated fire doors and status indication for all fire doors
- control and power systems to power operated watertight doors and their status indication
- emergency lighting
- public address system
- low location lighting (see UI SC 135)
- emergency fire pump
- remote emergency stop/shut-down arrangements for systems which may support the propagation of fire and/or explosion

**15.2 Installation**

For installation of fire-resistant cables, the following shall be observed:

- The cables shall be arranged in such a way as to minimize the loss of operational availability as a result of a limited fire in any area.
- The cables shall be installed as straight as possible and with strict observance of special installation requirements, e.g. permitted bending radii.



## **E. Requirements for Busbar Trunking Systems Intended for the Electrical Supply of Distribution Panels and Single Consumers**

### **1. Scope**

The following listed additional requirements are valid for the design and the installation of busbar trunking systems, which are installed outside of switchboards and are intended for the supply of distribution boards or single consumers.

Busbar trunking systems shall not be installed in explosion endangered areas and on the open deck.

### **2. Components of the busbar trunking system**

A busbar trunking system consists of the following components:

- Electrical conductors including neutral and protective conductors, their insulation and the encasement of the busbar trunking system
- connecting elements
- separation units
- insulators and fixing elements
- arc barriers
- tap-off units
- bulkhead and deck penetrations
- protection devices

### **3. Requirements**

#### **3.1 Basic requirements**

The safety standard and availability of ship mains designed to include busbar trunking systems shall be at least equivalent to those of conventionally cables ship mains, even in case of failure.

Busbar trunking systems shall comply with the requirements of IEC 61439-1 and IEC 61439-6.

#### **3.2 Requirements for components**

##### **3.2.1 Degree of protection**

The design of the busbar trunking system shall comply with the following minimum degrees of protection:

- dry spaces, e.g. accommodation, IP 54
- wet spaces, e.g. engine rooms, IP 56

The operational readiness of the busbar trunking system shall be not impaired by condensed moisture. Where required means for automatic draining shall be provided.

Busbar trunking systems shall be protected against mechanical damage.

##### **3.2.2 Bulkhead and deck penetrations, fire protection**

The used materials shall be halogen-free and shall be flame-retardant according to IEC 60695-2.

The whole busbar trunking system shall meet with regard to the fire test requirements as specified in IEC 60332-1-1 and IEC 60332-1-2.

Bulkhead and deck penetrations for busbar trunking systems shall conform to categories laid down by SOLAS and shall not impair the mechanical strength and the water tightness of bulkheads and decks.

The propagation of smoke via the busbar trunking system shall be effectively prevented.

### 3.3 System requirements

#### 3.3.1 System configuration

The design of busbar trunking systems shall be such that in case of a single failure the supply to redundant essential equipment continues. Redundant essential equipment shall be supplied via separate busbar trunking systems. Common busbar systems for main and emergency supply are not permitted.

Where a busbar trunking system is arranged below the uppermost continuous deck, the vessel's manoeuvrability and the operation of all installations necessary for the main purpose of the vessel as well as the safety of the crew and passengers shall not be impaired in the event of one or more watertight compartments outside the engine room being flooded.

Where busbar trunking systems are led through several watertight sections, means for separation at the supply-side of the transitions shall be provided. The units for separation shall be approachable, marked for identification and secured against unauthorized uncovering.

#### 3.3.2 Protection devices

Busbar trunking systems shall be protected against overload and short-circuit.

Switchgear of the busbar trunking system shall be arranged with regard to selectivity.

The propagation of electric areas along the busbar trunking system shall be prevented by arc barriers or other means. If current limiting circuit breakers are used, those means are not required.

### 4. Tests

#### 4.1 Aboard tests

On the basis of approved documentation an aboard test of the completed installation shall be made. This includes the functional testing of the busbar trunking system and the check of settings for protection devices.

#### 4.2 Type-approval

Busbar trunking systems are subject to mandatory type approval. For scope of test see [Guidance for Approval and Type Approval of Materials and Equipment for Marine Use \(Pt.1, Vol.W\) Sec.3.T](#).

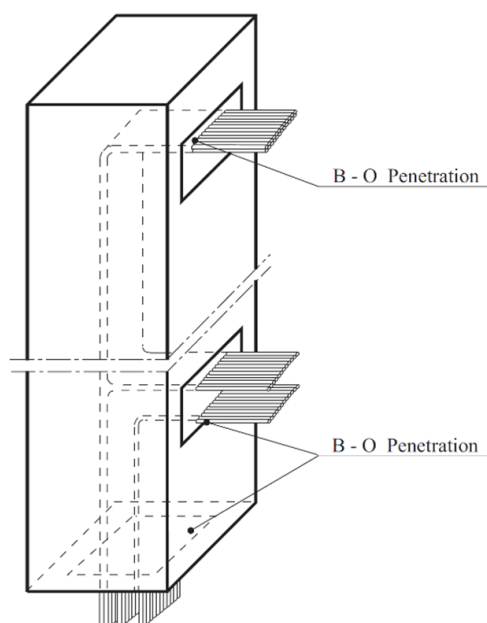
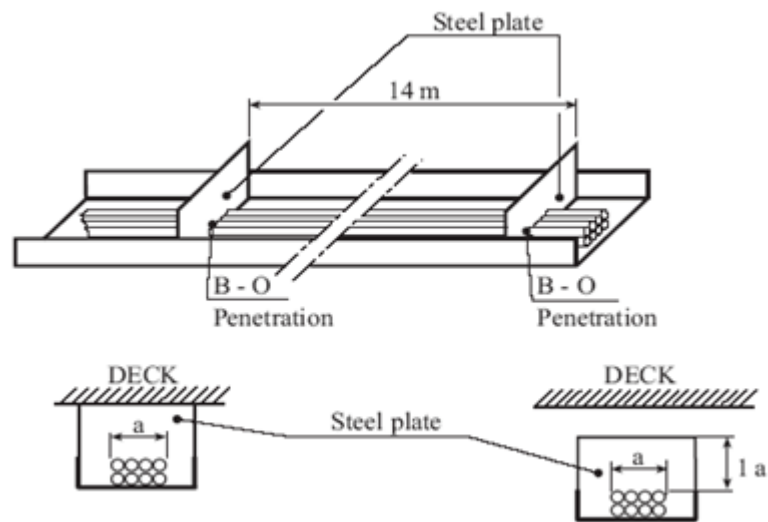
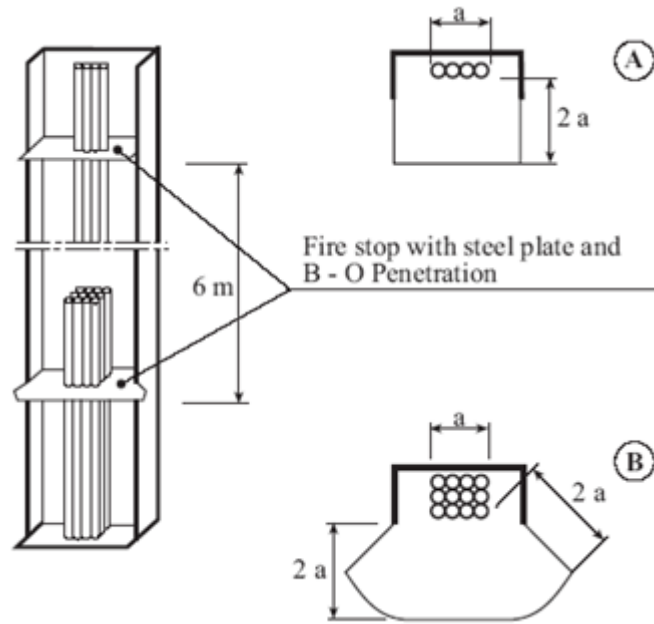

Figure 12.1: Fire stops, all steel plates at least 3 mm thick



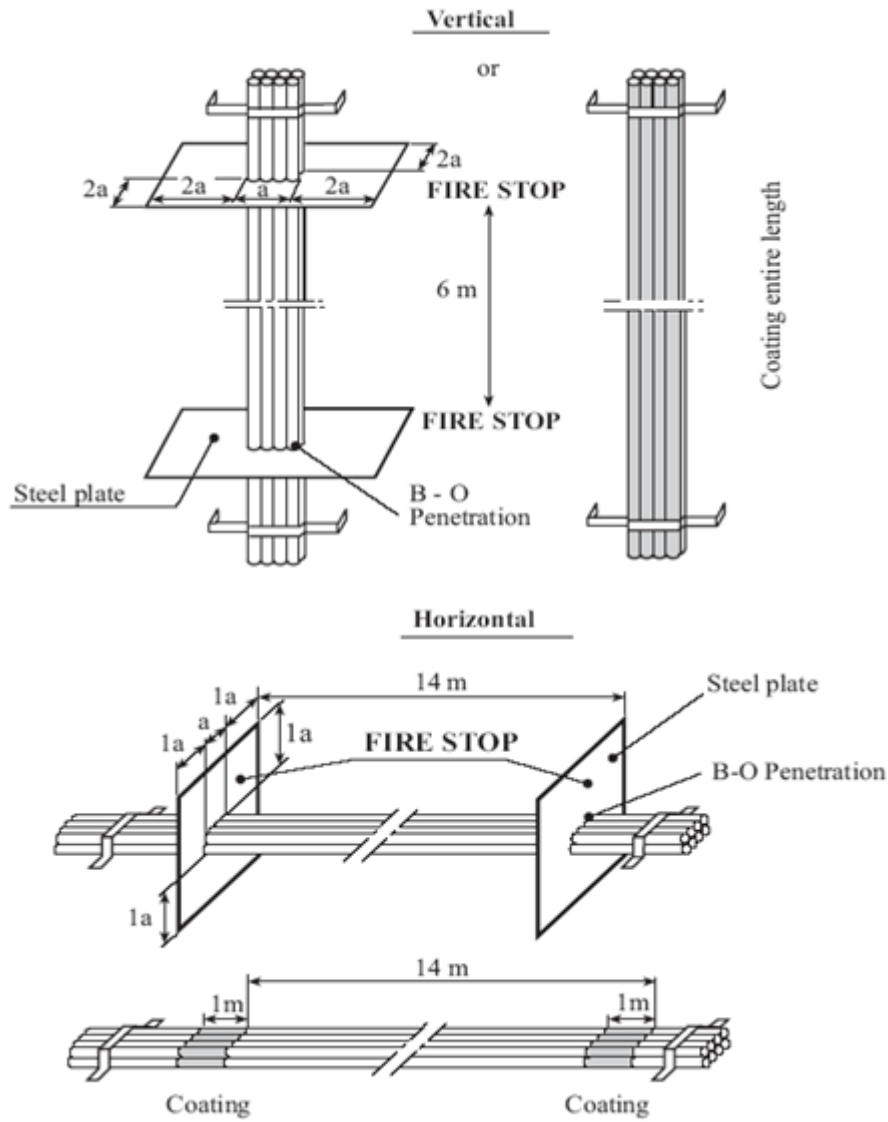

Figure 12.4: Open cable runs

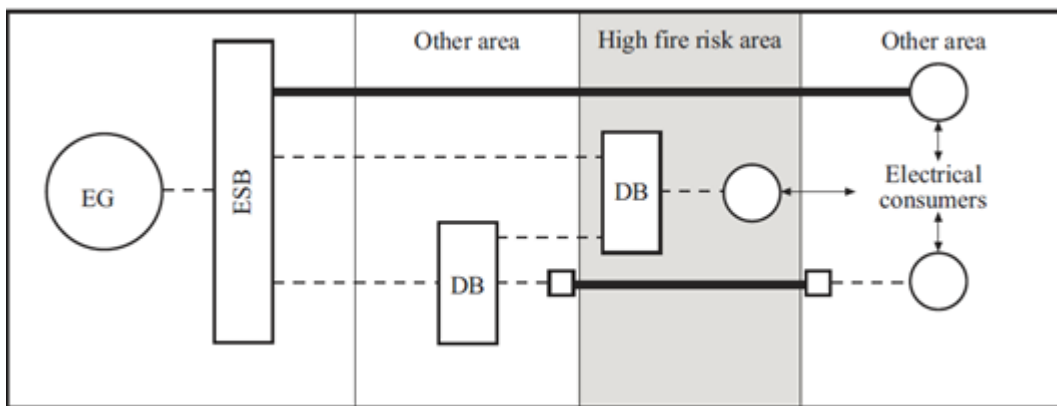

Figure 12.5: Installation of fire resistant cables through high fire risk areas

**Table 12.6: Current-carrying capacity of cables, maximum permissible conductor operating temperature of 60 °C and 75 °C**

Nominal cross-section		Current-carrying capacity based on a maximum conductor operating temperature of					
		60 °C			75 °C		
		S1 cont. operation	S2-30 min	S2-60 min	S1 cont. operation	S2-30 min	S2-60 min
mm <sup>2</sup>	AWG/MCM	A max.	A max.	A max.	A max.	A max.	A max.
<b>Single core cables</b>							
1,0	17	8	8	8	13	14	14
1,5	15	12	13	13	17	18	18
2,5	13	17	18	18	24	25	25
4	11	22	23	23	32	34	34
6	9	29	31	31	41	43	43
10	7	40	42	42	57	60	60
16	5	54	57	57	76	81	81
25	3	71	76	75	100	107	106
35	2	87	94	92	125	135	133
50	0	105	114	111	150	164	159
70	2/0	135	150	143	190	211	201
95	4/0	165	186	177	230	260	246
120	250	190	220	203	270	313	289
150	300	220	260	238	310	366	335
185	400	250	305	273	350	427	382
240	500	290	365	322	415	523	461
300	600	335	439	379	475	622	537
<b>2-core cables</b>							
1,0	17	7	7	7	11	12	12
1,5	15	10	11	11	14	15	15
2,5	13	14	15	15	20	21	21
4	11	19	21	20	27	29	29
6	9	25	27	27	35	38	37
10	7	34	38	36	48	53	51
16	5	46	52	49	65	73	70
25	3	60	71	65	85	101	92
<b>3- or 4-core cables</b>							
1,0	17	6	6	6	9	10	10
1,5	15	8	9	8	12	13	13
2,5	13	12	13	13	17	18	18
4	11	15	16	16	22	24	23
6	9	20	22	21	29	32	31
10	7	28	31	30	40	45	42
16	5	38	43	41	53	60	57
25	3	50	60	55	70	84	76
35	2	61	76	67	87	108	96
50	0	73	95	82	105	137	118
70	2/0	94	129	108	133	182	153
95	4/0	115	165	137	161	232	192
120	250	133	200	162	189	284	231
<b>Multi-core cables</b>							
5	x 1,5	5	x 15	7			10
7	x 1,5	7	x 15	6			9
10	x 1,5	10	x 15	5			8
12	x 1,5	12	x 15	5			7
14	x 1,5	14	x 15	5			7
16	x 1,5	16	x 15	5			7
19	x 1,5	19	x 15	4			6
24	x 1,5	24	x 15	4			6
AWG : American Wire Gauge MCM : Mille Circular Mil							

**Table 12.7: Current-carrying capacity of cables, maximum permissible conductor operating temperature of 80 °C and 85 °C**

Nominal cross-section		Current-carrying capacity based on a maximum conductor operating temperature of					
		80 °C			85 °C		
		S1 cont. operation	S2-30 min	S2-60 min	S1 cont. operation	S2-30 min	S2-60 min
mm <sup>2</sup>	AWG/MCM	A max.	A max.	A max.	A max.	A max.	A max.
<b>Single core cables</b>							
1,0	17	15	16	16	16	17	17
1,5	15	19	20	20	20	21	21
2,5	13	26	28	28	28	30	30
4	11	35	37	37	38	40	40
6	9	45	48	43	48	51	51
10	7	63	67	67	67	71	71
16	5	84	89	89	90	95	95
25	3	110	118	117	120	128	127
35	2	140	151	148	145	157	154
50	0	165	180	175	180	196	191
70	2/0	215	239	228	225	250	239
95	4/0	260	294	278	275	311	294
120	250	300	348	321	320	371	342
150	300	340	401	367	365	431	394
185	400	390	476	425	415	506	452
240	500	460	580	511	490	617	544
300	600	530	694	599	560	734	633
<b>2-core cables</b>							
1,0	17	13	13	13	14	14	14
1,5	15	16	17	17	17	18	18
2,5	13	22	24	24	24	26	25
4	11	30	32	32	32	35	34
6	9	38	41	40	41	45	43
10	7	53	59	56	57	63	60
16	5	71	80	76	76	86	81
25	3	93	111	100	102	121	110
<b>3- or 4-core cables</b>							
1,0	17	10	11	11	11	12	12
1,5	15	13	14	14	14	15	15
2,5	13	18	19	19	20	22	21
4	11	24	26	25	27	29	29
6	9	31	34	33	34	37	36
10	7	44	49	47	47	53	50
16	5	59	67	63	63	72	67
25	3	77	92	84	84	101	92
35	2	98	122	108	101	125	111
50	0	115	150	129	126	164	141
70	2 /0	150	206	173	157	215	181
95	4 /0	182	262	217	192	276	228
120	250	210	315	256	224	336	273
<b>Multi-core cables</b>							
5 x 1,5	5 x 15	11			12		
7 x 1,5	7 x 15	11			10		
10 x 1,5	10 x 15	9			9		
12 x 1,5	12 x 15	8			9		
14 x 1,5	14 x 15	8			8		
16 x 1,5	16 x 15	7			8		
19 x 1,5	19 x 15	7			7		
24 x 1,5	24 x 15	7			7		

AWG: American Wire Gauge  
 MCM: Mille Circular Mil

**Table 12.8: Current-carrying capacity of cables, maximum permissible conductor operating temperature of 85 °C (JIS)\***

Nominal cross-section to JIS*	Current-carrying capacity based on a maximum conductor operating temperature of 85 °C (JIS)*		
	S 1 continuous operation	S 2-30 min	S 2-60 min
mm <sup>2</sup>	A max.	A max.	A max.
<b>Single core cables</b>			
1,25	18	19	19
2,0	25	26	26
3,5	35	37	37
5,5	46	49	49
8,0	59	63	63
14,0	83	88	88
22,0	110	117	117
30,0	135	144	143
38,0	155	167	164
50,0	185	202	196
60,0	205	228	217
80,0	245	277	262
100,0	285	331	305
125,0	325	384	351
150,0	365	445	398
200,0	440	554	488
250,0	505	662	571
<b>2-core cables</b>			
1,25	16	17	17
2,0	21	22	22
3,5	30	32	32
5,5	39	42	41
8,0	50	55	53
14,0	71	79	75
22,0	94	106	101
30,0	115	137	124
<b>3 core cables</b>			
1,25	13	14	14
2,0	17	18	18
3,5	25	27	27
5,5	32	35	34
8,0	41	45	43
14,0	58	65	61
22,0	77	88	82
30,0	94	113	102
38,0	110	136	121
50,0	130	169	146
60,0	145	199	167
80,0	175	252	208
100,0	200	300	244
<b>Multi-core cables</b>			
5 x 1,25	11		
7 x 1,25	10		
9 x 1,25	9		
12 x 1,25	8		
16 x 1,25	7		
19 x 1,25	6		
23 x 1,25	6		
27 x 1,25	6		

\*Japanese Industrial Standard

**Table 12.9: Current-carrying capacity of cables, maximum permissible conductor operating temperature of 90 °C and 95 °C**

Nominal cross-section		Current-carrying capacity based on a maximum conductor operating temperature of					
		90 °C			95 °C		
		S1 cont. operation	S2-30 min	S2-60 min	S1 cont. operation	S2-30 min	S2-60 min
mm <sup>2</sup>	AWG/MCM	A max.	A max.	A max.	A max.	A max.	A max.
<b>Single core cables</b>							
1,0	17	18	19	19	20	21	21
1,5	15	23	24	24	24	25	25
2,5	13	40	43	43	32	34	34
4	11	51	54	54	42	45	45
6	9	52	55	55	55	58	58
10	7	72	77	77	75	80	80
16	5	96	102	102	100	106	106
25	3	127	135	134	135	144	143
35	2	157	170	167	165	178	175
50	0	196	214	208	200	218	212
70	2/0	242	269	257	255	283	270
95	4/0	293	331	314	310	350	332
120	250	339	390	262	360	410	385
150	300	389	459	420	410	484	443
185	400	444	541	484	470	573	512
<b>2-core cables</b>							
1,0	17				17	18	18
1,5	15	20	21	21	20	21	21
2,5	13	26	28	28	27	29	29
4	11	34	37	36	36	39	38
6	9	44	48	46	47	51	50
10	7	61	68	65	64	71	68
16	5	82	93	88	85	96	91
25	3	108	128	116	115	137	124
<b>3- or 4-core cables</b>							
1,0	17				14	15	15
1,5	15	16	17	17	17	18	18
2,5	13	21	23	22	22	24	23
4	11	28	30	30	29	32	31
6	9	36	39	38	38	42	40
10	7	50	56	53	52	58	55
16	5	67	77	72	70	80	75
25	3	89	107	97	94	113	102
35	2	110	136	121	115	143	127
50	0	137	178	153	140	182	157
70	2/0	169	232	195	178	244	205
95	4/0	205	295	244	217	312	258
120	250	237	356	289	252	378	307
<b>Multi-core cables</b>							
5	x 1,5	5	x 15			14	
7	x 1,5	7	x 15			13	
10	x 1,5	10	x 15			11	
12	x 1,5	12	x 15			10	
14	x 1,5	14	x 15			10	
16	x 1,5	16	x 15			9	
19	x 1,5	19	x 15			9	
24	x 1,5	24	x 15			8	

AWG: American Wire Gauge  
 MCM: Mille Circular Mil



## Section 13 Additional Rules for Electrical Main Propulsion Plants

A.	General . . . . .	13-1
B.	Drives . . . . .	13-2
C.	Static Converter Installations . . . . .	13-3
D.	Propulsion transformers . . . . .	13-5
E.	Control Stations . . . . .	13-5
F.	Ships' Mains . . . . .	13-6
G.	Control and Regulating . . . . .	13-6
H.	Protection of the Plant . . . . .	13-7
I.	Measuring, Indicating, Monitoring and Operating Equipment . . . . .	13-8
J.	Cables and Cable Installation . . . . .	13-11
K.	Construction Supervision, Testing and Trials . . . . .	13-11
L.	Additional Rules for Ships with Redundant Propulsion Systems (RP1x%, RP2x% or RP3x%) . . . . .	13-13

### A. General

1. A ship has an electrical main propulsion plant if the main propulsion is produced by at least one electrical propulsion motor, or if this motor provides temporarily the entire propulsive power.
2. If a propulsion plant has only one propulsion motor and the ship has no additional propulsion system which ensures sufficient propulsive power, then this plant shall be so structured that, following a malfunction in the static converter or in the regulation and control system, at least a limited propulsion capability remains.
  - 2.1 As the minimum requirement for an electrical main propulsion plant, the following requirements apply:
    - At least two mutually independent static converters shall be provided, with mutually independent cooling systems, regulating systems, reference value inputs, actual value acquisition, etc.
    - The supply of the power circuits shall be provided by separate cables from different sections of the propulsion switchboard.
3. Auxiliary propulsion plants are additional propulsion systems.
4. The engines driving the generators for the electrical propulsion plant are main engines, the motors driving the propeller shaft, or the thrusters are propulsion motors.
5. If electrical main propulsion plants are supplied from the ship's general mains, the Rules in this Section apply also to the generators and the associated switchgear.
6. The static converters shall be easily accessible for inspection, repair and maintenance.
7. Equipment shall be provided to support the fault diagnosis process.
8. IEC 60092-501: "Special features – Electric propulsion plant" shall be considered.

## B. Drives

### 1. Basis for dimensioning

1.1 The electrical machinery and plants shall, in accordance with their service and operating conditions, be designed for short periods of overload and for the effect of manoeuvres and the state of sea.

1.2 The lubrication of machinery and shafting shall be designed to be adequate for the entire speed range of rotation in both directions including towing.

1.3 Each shaft shall be fitted with an adequately dimensioned locking device that permits towing of the ship, or the operation of other propulsion systems, without rotation of the locked, non-driven shaft.

The remaining drives may be operated at reduced power, provided that sufficient manoeuvring capability is ensured.

### 2. Main engines

The main engines shall also conform to the requirements of [Rules for Machinery Installations \(Pt.1, Vol.III\), Section 2](#).

2.1 The diesel governors shall ensure safe operation under all running and manoeuvring conditions, this for both single operation and parallel operation.

2.2 The response on different reduction alarms shall be agreed with BKI.

2.3 When manoeuvring, for example from full propeller speed ahead to full propeller speed astern, regenerated power may occur.

The amount of regenerated power shall be limited by the control system, so that tripping due to overspeed or reverse power is avoided.

Means external to the mechanical and electrical rotating machinery may be provided in the form of for example braking resistors to absorb excess amounts of regenerated energy and to reduce the speed of the propulsion motor.

### 3. Propulsion motors

The propulsion motors shall also conform to the requirements of [Section 20, A](#).

3.1 The effects of the harmonics of currents and voltages shall be taken into consideration for the design of the propulsion motors.

3.2 The winding insulation shall be designed to withstand the over-voltages which may arise from manoeuvres, switching operations, converter operation and earth faults.

3.3 Separately cooled machines shall be so dimensioned that, in case of failure of the separate cooling, limited operation is still possible. Versions deviating from this principle require the agreement of BKI.

3.3.1 It shall be possible to check the function of the cooling system by means of local temperature indicators (e.g. water: inlet and outlet; air: intake and discharge).

If it is not possible to install local, directly measuring thermometers, external indicators which are independent from other systems shall be provided.

It shall be ensured that water due to leakage or condensation is kept away from the windings.

3.4 Electrical propulsion motors shall be able to withstand without damage a short-circuit at their terminals and in the system under rated operating conditions until the protection devices respond.

3.5 All stator winding ends shall be routed to terminals in the terminal box and to be connected only there.

## C. Static Converter Installations

### 1. General

- 1.1 Power-electronic equipment shall also conform to the requirements of [Section 6](#).
- 1.2 Static converters shall be designed for all operating and manoeuvring conditions including overload.
- 1.3 For the design of the static converter cabinets, the requirements for main switchboards shall be applied as and where appropriate.
- 1.4 Common control of the static convertor is not permitted.

### 2. Converter assemblies

- 2.1 For separately cooled static converters, independent cooling systems shall be provided for each converter.

If static converters are separately cooled, it shall be possible to continue operation of the plant at reduced power in the event of failure of its cooling system.

Failure of the cooling system shall be signalled by an alarm.

The temperature of the converter cabinet as well as the temperature of the power semiconductors or of the heat sinks shall be monitored.

- 2.2 If limited operation of liquid cooled static converters is not possible after failure of the separate cooling system, then two coolant pumps with the corresponding stand-by circuits shall be provided

- 2.3 For liquid-cooled static converters, the following monitoring arrangements shall be provided in addition:

- coolant flow or differential pressure
- coolant leakage
- coolant pressure
- coolant conductivity
- coolant temperature
- failure of the coolant pumps/fans
- stand-by alarm of the coolant pumps

- 2.4 For the components of the DC link, the following monitoring arrangements shall be provided:

- temperature monitoring of the DC link reactor
- under-voltage and overvoltage monitoring
- current monitoring
- short-circuit monitoring
- current monitoring of the braking resistor

- 2.5 The input supply shall be provided with the following monitoring arrangements:

- failure of the supply
- over-voltage
- under-voltage
- under-frequency

These values shall be coordinated with the mains supply protection and the generator protection.

2.6 The following internal monitoring equipment shall be provided for the static converter:

- semiconductor failure
- semiconductor fuse failure
- firing pulse error
- control deviation
- system error of the control system
- actual speed / rotor position encoder failure
- current actual value failure
- faulty set point input
- power supply failure
- failure in the bus system

### 3. Main and exciter power circuits

3.1 The circuits for main power supply and exciters shall be supplied directly from the switchboard and shall be separate for each motor respectively each winding system.

The exciter shall be supplied from the dedicated section of the main or propulsion switchboard supplying the main circuit. This applies also to other auxiliary systems.

DC motors and separately excited machines designed as a single drive shall be fitted with two exciter devices.

3.2 The main circuits shall be supplied through remotely actuated circuit-breakers.

3.3 In the supply of exciter circuits, only short-circuit protection shall be provided.

3.4 In the event of failure of the excitation, the corresponding power component shall also be switched off. Failure of the excitation system shall be signalled by an alarm.

### 4. Installation according to IEC 60533

4.1 Plants that do not meet the requirements set out in the [Guidance for The Approval and Type Approval of Materials and Equipment for Marine Use \(Pt.1, Vol.W\) Sec.3.V](#) relating to the stray radiation from the housing and/or the conducted interference shall be installed in separate spaces.

4.1.1 The supply lines, and the cables to the propulsion motor, shall be run separately from each other and from other cables.

4.1.2 Such plants shall be supplied via transformers.

### 5. Filter circuits

5.1 If filter circuits are used to reduce the harmonics, these circuits shall be protected against overload and short-circuit.

5.2 Filters shall be monitored for failure.

5.3 The operating instructions shall document which propulsion settings and generator combinations are admissible after failure of one or all of the filters. This shall be verified by means of a THD measurement.

5.4 Filters shall function properly in all propulsion settings and grid configurations and shall not lead to increases in voltage or current. This shall be verified through measurements during the sea trial.

## D. Propulsion transformers

### 1. General

- 1.1 At least two independent propulsion transformers shall be installed
- 1.2 Transformer with complete insulation between primary winding and secondary winding shall be used. Auto transformer are permitted for motor starting.
- 1.3 Transformer producing low voltage from medium voltage shall be equipped with an earthed shield winding between the low-voltage and medium-voltage coil.
- 1.4 Means for monitoring the temperature of propulsion transformers are to be provided.
- 1.5 Degree of protection

Transformer located in engine room are to have a protection degree of at least IP 23 and high voltage transformer are to have a protection degree of at least IP 44. All transformers located in dedicated locked electrical space or in the space which can access to qualified personnel only as engine room may have any degree of protection of at least IP 20.

### 2. Cooling

#### 2.1 Liquid cooled transformers

- a fire detector and a suitable fire extinguishing system are to be installed in the vicinity of the transformer.
- liquid cooled transformers are to be provided with gas-actuated protection device.
- means of monitoring the liquid temperature is to be provided. A pre-alarm is to be actuated before the maximum permissible temperature is attained. When the maximum permissible temperature limit is reached, the transformer is to be switch off.
- the liquid filling level is to be monitored by means of two separate sensors. The monitoring system is to actuate an alarm at the first stage and is to trigger a shut-down at the second stage, when the permissible limit is exceeded.

### 3. Instrumentation

Propulsion transformer are to be equipped with a three-phase ammeter on primary side.

### 4. Protection

- 4.1 Each propulsion transformer is to be protected against over current and short-circuit at primary and secondary side.
- 4.2 Protection on secondary side may be achieved by the static converter

## E. Control Stations

Control equipment shall conform to [Rules for Automations \(Pt.1, Vol.VII\)](#), as and where appropriate. Additionally, the following Rules apply:

1. Where the propulsion main control station is located on the bridge, provisions shall be made for the control of the propulsion plant also from the engine room and control room.
2. For any arbitrary fault of the automatic remote control and the propulsion main control stations, local operation shall be possible from the local control station.

2.1 Changeover shall be possible within a reasonably short time. The local control station shall receive the highest priority, and it shall be possible to select this control station locally.

This control station shall be connected directly to the corresponding static converter.

It shall be ensured that control is only possible from one control station at any time. Transfer of command from one control station to another shall only be possible when the respective control levers are in the same position and when a signal to accept the transfer is given from the selected control station.

The loss of control at the concerned control station is to be signalled optically and audibly.

2.2 Ships with a restricted service area may, with the consent of BKI, have only one propulsion main control station on the bridge and a local control station.

2.3 It shall be possible to acknowledge all mal-functions at the local control station.

2.4 At the propulsion main control station, it shall be possible to acknowledge at least all those malfunctions that are caused by the auxiliary services or by the supply network. After a black-out, it shall be possible to restart the propulsion at the propulsion main control station.

3. The propulsion main control stations on the bridge and in the engine control room as well as the local control station shall be provided with an emergency stop device that is independent of the main control system. The emergency stop device in the engine control room shall be provided even if only control positions according to 2.2 exists.

4. All operating functions shall be made logical and simple, to prevent mal-operation. The operating equipment shall be clearly arranged and marked accordingly.

5. A malfunction in a system for synchronising or in a position equalisation device for controlling the operating levers of several control stations shall not result in the failure of the remote control from the main control position.

## F. Ships' Mains

1. It shall be possible to connect and disconnect generators without interrupting the propeller drive.

2. If a power management system is used, the automatic stop of main engines during manoeuvring shall be prevented.

2.1 During estuary operation, each main busbar section shall be supplied by at least one generating set.

### 3. Propulsion switchboards

The propulsion switchboard mainly distributes the energy to the propulsion system.

3.1 If the total installed power of the main generator exceeds 3 MW, the propulsion switchboard shall be provided with a circuit-breaker for sectionalising the plant.

3.2 Propulsion switchboards shall meet the requirements for main switchboards as and where appropriate.

## G. Control and Regulating

Generally, the control and regulating functions of the propulsion plant shall be completely independent of other systems. In normal operation computers and bus systems shall be permanently assigned to the corresponding drive train. The failure of other control and monitoring equipment shall not lead to malfunctions in the propulsion plant.

If alarms are passed on to the machinery alarm system by means of collective alarms, it shall be considered that each additional new single alarm will re-annunciate this collective alarm; see also [Section 9.B.](#) and [Rules for Automations \(Pt.1, Vol.VII\)](#).

1. An automatic power limitation and reduction of the propulsion plant shall ensure that the ship mains and propulsion network are not loaded inadmissibly.

2. In the event of overcurrent, under-voltage, under-frequency, reverse power and overload, the propulsion shall be limited or reduced accordingly.
3. Upon failure of a generator or a bus tie breaker, the resulting load surge shall be limited to the admissible values by the drives.
4. The reverse power applied during reversing or speed-reducing manoeuvres shall be limited to the acceptable maximum values.

## H. Protection of the Plant

### 1. General

1.1 Automatic tripping of the propulsion plant, such that it impairs the ship's manoeuvring capability, shall be limited to such malfunctions which would result in serious damage within the plant.

1.2 The actuation of protection, reducing and alarm devices shall be indicated optically and audibly. The alarm condition shall remain recognisable even after switching off. A limitation of the running-up of the propulsion plant that is caused by generators reaching their maximum output should not be signalled as an alarm.

1.3 The protection concept for the propulsion motor shall be described and agreed with BKI.

1.4 The settings of the protection devices for the generators, transformers and propulsion motors shall be coordinated with the settings of the power management system and those of the propulsion plant's converters. Any protection devices in the exciter circuits shall be deactivated or adjusted so that they respond subsequently.

2. Protection devices shall be set to such values that they do not respond to overload occurring under normal service condition, e.g. while manoeuvring or in heavy seas.

3. Defects in reducing and stopping devices shall not impair the limited propulsion capability in accordance with A.2.

4. In the event of failure of an actual or reference value, it shall be ensured that the propeller speed does not increase unacceptably, that the propulsion is not reversed, or that dangerous operating conditions can arise. The same applies to failure of the power supply for the control and regulating functions.

5. The following additional protection equipment shall be provided:

- Where drives can be mechanically blocked in an uncontrolled manner, they shall be provided with monitoring equipment which prevents damage to the plant.
- overspeed protection
- protection against overcurrent and short-circuit
- earth fault monitoring of stator and exciter windings
- protection device which detects internal faults of the motor (e.g. differential protection) for propulsion motors with an output of more than 1500 kW
- Following an internal fault in the motor or a short-circuit in the output circuit, various measures may be necessary, depending on the location of the damage and the motor type. Error indication shall make it possible to identify the damaged parts of the plant. The feeder breakers and the disconnectors shall open automatically, insofar as they serve to limit the damage.

### 6. Permanently excited motors

6.1 For Permanently excited motors and motors with several stator windings, a disconnector shall be arranged between the motor terminals and the static converter.

6.2 In the case of a fault below the disconnecter of permanently excited motors, the ship shall be stopped as soon as possible, and the corresponding shaft shall be locked. The corresponding alarm shall be provided at the control station. The installation shall be so designed that it is able to carry the short-circuit current of the motor for the stopping time. The disconnecter shall have a corresponding switching capacity. In the event of faults in the output circuit of the static converter, this disconnecter shall open automatically.

### 7. Separately excited motors

7.1 For separately excited motors the disconnecters in the main circuit shall open and the exciter devices shall be switch off in the event of faults in the output circuit.

### 8. Asynchronous motors

8.1 For asynchronous motors, it is sufficient to switch off the static converter and, if applicable, to open disconnecting devices for single windings.

9. The transformers of propulsion plants shall be protected against over current and short circuit. Medium-voltage transformers of propulsion plants shall be equipped with an earthed shield winding. Propulsion transformers shall be monitored for over temperature. Propulsion transformers with an output of more than 1500 kVA shall be equipped with differential protection.

## I. Measuring, Indicating, Monitoring and Operating Equipment

Faults in measuring, indicating, monitoring and operating equipment shall not cause any failure of the control and regulating functions.

### 1. Measuring equipment and indicators

Main propulsion plants shall be provided with at least the following measuring equipment and indicators at control stations:

#### 1.1 At a local control station:

- ammeter and voltmeter for each supply and each load component
- ammeter and voltmeter for each exciter circuit
- revolution indicator for each shaft
- pitch indicator for plants with variable-pitch propellers
- indication of the generators used for propulsion or the reserve power that is still available
- on/off pushbuttons for each static converter
- on/off signals for each static converter
- selected static converter
- plant ready for switching on
- plant ready for operation
- plant disturbance
- control from engine control room
- control from the bridge
- control from the local control station
- reduced power and pushbutton "Override reduction" or "request for reduction"
- system-dependent alarms
- power limitation



**1.2** At the propulsion main control station in the engine control room:

- power meter
- revolution indicator for each shaft
- pitch indicator for plants with variable-pitch propellers
- indication of the generators used for propulsion or the reserve power that is still available
- on/off pushbuttons for each static converter
- on/off signals for each static converter
- plant ready for switching on
- plant ready for operation
- plant disturbance
- reduced power and pushbutton “Override reduction” or “request for reduction”
- control from engine control room
- control from the bridge
- control from the local control station
- indication of the generators used for propulsion
- changeover switch for port, estuary and sea operation
- system-dependent alarms
- power limitation

**1.3** Propulsion main control station on the bridge:

- revolution indicator for each shaft
- pitch indicator for plants with variable-pitch propellers
- load indication of the generators used for propulsion or indication of the available power reserve
- on/off pushbuttons for each static converter
- on/off signals for each static converter
- plant ready for switching on
- plant ready for operation
- plant disturbance
- reduced power and pushbutton “Override reduction” or “request for reduction”
- control from engine control room
- control from the bridge
- control from the local control station
- system-dependent alarms
- power limitation

## 2. Monitoring equipment

The actuation of the following monitoring equipment shall be signalled optically and audibly:

**2.1** Monitoring of the ventilators and temperatures of the cooling air for forced ventilation of machines and transformers.

**2.2** Monitoring of the flow rate and leakage of coolants for machines and transformers with closed cooling systems.

In the secondary cycle, at least the inlet temperature shall be registered. The separate cooling system shall be monitored for failure.

**2.3** For generators above 500 kVA and for motors and transformers, winding-temperature monitoring shall be provided.

**2.4** Bearing-temperature monitoring shall be provided for generators above 1500 kVA and for propulsion motors. A thermometer shall be installed locally for monitoring purposes. If the bearings are inaccessible, the temperature measurement system shall be designed to provide redundancy.

**2.5** Bearings with external lubrication shall be monitored for adequate lubrication under all operating conditions (e.g. pressure, flow rate, filling level).

The oil temperature shall be monitored.

A sight glass shall be provided for manual inspection. If the bearings are inaccessible, the lubrication monitoring system shall be designed to provide redundancy. See also [Section 20, A.1.5](#).

**2.6** Both end positions of the shaft locking device (locked and released) shall be monitored. An alarm shall be triggered if the locking device is in an inadmissible position.

**2.7** In the case isolated networks or subnetworks, the insulation resistance shall be monitored.

## 3. Alarm coordination

Generally, a pre-alarm should be triggered, wherever possible, before shut-down or reduction of the propulsion plant.

## 4. Start Blocking

The start-up process of the propulsion plant shall be interlocked that starting is impossible if existing malfunctions would trigger a shutdown or if the start-up process itself would cause damage to the propulsion plant.

### 4.1 Start Blockings:

- shaft locking device not released
- no cooling of static converter (overridable)
- no cooling of propulsion motor (overridable)
- no cooling of propulsion transformer (overridable)
- malfunction in exciter device
- malfunction in static converter
- converter control: shutdown activated
- propulsion switchboard switch-off active
- emergency stop actuated

- setpoint not equal to zero
- bearings: lubrication oil pressure too low
- conductivity of the cooling medium too high
- protection triggered
- circuit breaker malfunction
- missing enabling signal from variable-pitch propeller

4.2 The pilot light “plant ready for switching on” may only be activated when all the prerequisites for start-up have been met.

4.3 The pilot light “plant ready for operation” may only be activated if the propulsion plant would respond to set point setting.

## J. Cables and Cable Installation

The cable network for electrical propulsion plants shall comply with the requirements of [Section 12](#).

If there is more than one propulsion unit, the cables of any one unit shall, as far as is practicable, be run over their entire length separately from the cables of the other units.

## K. Construction Supervision, Testing and Trials

### 1. Supervision during construction

Propulsion motors, generators, static converters and switchgear as part of the main propulsion plant are subject to supervision during construction by BKI.

To allow supervision during construction, a quality assurance plan shall be submitted to BKI.

The quality assurance plan shall contain the planned internal receiving, in-process and final inspections/tests, together with the relevant test instructions and the planned test records. The hold points with participation of BKI will be determined on the basis of the quality assurance plan.

### 2. Testing and the manufacturer’s works

The following additional tests shall be carried out:

2.1 Tests of machines, static converters, switch-gear, equipment and cables shall be carried out at the manufacturer’s works in accordance with [Section 20](#) and [21](#).

#### 2.1.1 Testing of the static converters

.1 These tests shall meet the requirements of [Section 6](#) as and where appropriate. All alarms of the categories “Stop” and “Reduction” shall be documented with their limit values and tested. In the case of type-approved static converters, this is only necessary for the project-specific parameters.

.2 For type-approved static converters, the function of the general alarms shall be verified by spot checks. For static converters that are not type- approved, a complete test is required for the first converter of each series.

.3 Faults such as the failure of reference and actual value signals, power supply failure, ventilator failure, inadequate pressure and leakage of coolant, failure of miniature circuit-breakers, communication error etc. shall be listed together with their effects on the system and shall then be tested.

.4 The scope of tests for the first static converter of a series and for the subsequent converters shall be agreed with BKI in each case.

### 2.1.2 Testing of the propulsion switchboard

A complete test of the protection devices, interlocks, etc. shall be carried out in accordance with the test requirements for main switchboards.

### 2.1.3 Testing of the remote control

For the first vessel of a series the remote control shall be set up with all control stations and tested.

### 2.1.4 Testing of the transformers

A complete type and routine test shall be carried out according to IEC 60076 or verification thereof submitted. For the temperature-rise test, the effect of the harmonics shall be considered; see [Section 20.B](#).

### 2.1.5 Testing of the motors

A complete type and routine test shall be carried out according to IEC 60034. For the temperature-rise test, the effect of the harmonics shall be considered; see [Section 20.A](#).

### 2.1.6 Testing the power management system

The power management systems shall be subject to a functional test (software FAT) in the manufacturer's works. Joint testing with the propulsion switchboard is recommended.

A test specification shall be defined and agreed with BKI.

## 2.2 Testing of the shaft material for generators and propulsion motors

Proof of compliance with [Rules for Materials \(Pt.1, Vol.V\)](#), shall be provided by means of a shaft material test as for ship's shafting.

2.3 The testing of other important forgings and castings for electrical main propulsion plants, e.g. rotors and pole shoe bolts, shall be agreed with BKI.

2.4 BKI reserves the right to request additional tests.

## 3. Tests after installation

Newly-constructed or enlarged plants require testing and trials on board.

The scope of the trials shall be agreed with BKI.

### 3.1 Dock trial

Functioning of the propulsion plant shall be proved by a dock trial before sea trials.

At least the following trials/measurements shall be carried out in the presence of the Surveyor:

- start-up, loading and unloading of the main and propulsion motors in accordance with the design of the plant and a check of regulation, control and switchgear as far as possible.
- verification of propeller speed variation and all associated equipment
- verification of protection, monitoring and indicating/alarm equipment including the interlocks for roper function
- verification of the re-annunciation of collective alarms
- verification of the insulation condition of the main propulsion circuits
- for testing the ship mains, the main engines and the propulsion plant, a trial with a zero-thrust propeller or comparable equipment is recommended.

### 3.2 Sea trial

The trial programme shall at least include:

**3.2.1** Continuous operation of the ship at full propulsion load until the entire propulsion plant has reached steady-state temperatures.

The trials shall be carried out at rated engine speed and with an unchanged closed loop controls setting:

- at least 4 hours at 100 % power output (rated power), and at least 2 hours at the continuous power output normally used at sea.
- 10 minutes with the propeller running astern during the dock trial or during the sea trial at a minimum speed of at least 70 % of the rated propeller speed.

**3.2.2** Reversal of the plant out of the steady-state condition from full power ahead to full power astern and maintaining of this setting at least until the ship has lost all speed. Characteristic values, such as speed, system currents and voltages, and the load sharing of the generators, shall be recorded. If necessary, oscillograms shall be made.

**3.2.3** Performance of manoeuvres typically occurring in estuary trading (see [Guidance for Sea Trials of Motor Vessels \(Pt.1, Vol.B\)](#)).

**3.2.4** Checking of the machinery and plant in all operating conditions.

**3.2.5** Checking of the grid quality in the ship's propulsion network and mains:

- measurement at various propulsion speeds in normal operation.
- measurements with which the most unfavourable mains and propulsion plant configuration is determined.
- measurement at various propulsion speeds in most unfavourable mains and propulsion plant configuration
- Repeat measurement without THD filter as far as possible; see also [C.5.3](#).

The measurement results shall be recorded.

**3.2.6** Upon completion of the sea trial, a visual inspection of the components of the propulsion plant shall be performed. The insulation resistances of the propulsion transformers, propulsion motors and generators shall be determined and recorded.

## L. Additional Rules for Ships with Redundant Propulsion Systems (RP1x%, RP2x% or RP3x%)

See [Guidelines for Redundant Propulsion and Steering Systems \(Pt.1, Vol.XIII.\)](#)

*This page intentionally left blank*

## Section 14 Additional Rules for Passenger Vessels

A.	General . . . . .	14-1
B.	Installation of Electrical Equipment . . . . .	14-1
C.	Electrical Power Supply Systems . . . . .	14-2
D.	Control, Monitoring and Ship's Safety Systems . . . . .	14-5
E.	Lighting . . . . .	14-11
F.	Cable Network . . . . .	14-12

### A. General

#### 1. Scope

The general provisions these construction Rules, also apply, as and where appropriate, to passenger vessels, except where more particular requirements are laid down in this Section.

#### 2. References to other Rules

##### 2.1 Rules for Hull (Pt.1, Vol.II)

##### 2.2 Rules for Machinery Installations (Pt.1, Vol.III)

#### 3. References to international Regulations

3.1 Passenger ships shall have on board a safety centre complying with the requirements of SOLAS II-2, Reg. 23 and MSC.1/Circ.1368.

3.2 Passenger vessels having a length of 120 metres or more or having three or more main vertical fire zones shall also comply with SOLAS II-1, Reg. 8, 8-1 and Reg. II-2, 21 and 22<sup>1)</sup>.

### B. Installation of Electrical Equipment

1. Attention is drawn to special provisions for structural fire protection for control stations. Control stations are e.g.:

- location of the emergency source of electrical power
- bridge and chart room
- radio room
- main fire alarm and firefighting station
- engine control room if located outside the engine room
- rooms in which central stations for general emergency alarm and loudspeaker systems (PA systems) for emergency announcements are located

2. Switch and distribution boards in the passenger area shall not be accessible to passengers.

---

<sup>1)</sup>Applicable to passenger vessels with keel laying on or after 1 July 2010

## C. Electrical Power Supply Systems

### 1. Emergency electrical power supply

1.1 An independent emergency source of electrical power shall be provided.

1.2 The emergency source of electrical power shall be capable of simultaneously supplying at least the following equipment (if its operation depends on a source of electrical power) for the duration mentioned below, taking starting currents into account:

#### 1.2.1 Emergency illumination for 36 hours

- a) at all launching stations for survival appliances on deck and along the outside of the hull
- b) in all passageways of the service and accommodation area, on stairs and at exits and in passenger lift cars
- c) in the machinery rooms and main-generator stations, including their control positions
- d) at all control stations, engine control rooms, on the bridge and each main and emergency switchboard
- e) at all storage places for fireman's outfit
- f) in the steering gear compartment and the CO<sub>2</sub> room
- g) at the fire pumps listed in 1.2.4, the sprinkler pump and the emergency bilge pump, and at the starting-positions for their motors

#### 1.2.2 For 36 hours

- a) the navigation lights and any other signalling lights required in accordance with the "International Regulations for Preventing Collisions at Sea"
- b) the in SOLAS IV required "VHF radio installation" and, if necessary, the "MF radio installation" and the "ship earth station" and the "MF/HF radio installation"

#### 1.2.3 For 36 hours

- a) all internal communication systems and information equipment required in an emergency
- b) all ship navigation devices, which are required in SOLAS V/12
- c) the fire detection and fire alarm system and the system for operating and monitoring the fire doors
- d) devices for the intermittent operation of the day-light-signalling-lamp, the ship's siren, the manually operated fire alarm call points and all internal signals required in an emergency, such as General Emergency Alarm, CO<sub>2</sub> alarm

if these facilities cannot be supplied independently from an emergency storage battery for the duration of 36 hours.

#### 1.2.4 For 36 hours

- a) the stipulated emergency fire pumps
- b) the automatic sprinkler pumps
- c) the emergency bilge pump and all the devices necessary for the operation of electrically powered remotely controlled drainage valves
- d) the auxiliary equipment for the emergency diesel generator



**1.2.5** During the period stipulated by [Section 7, A.4.](#), the steering gear if an emergency supply is obligatory, and the rudder angle indicator.

**1.2.6** For 3 hours on Ro-Ro Passenger vessels the supplementary emergency illumination with self-contained luminaires, see [Section 16](#).

**1.2.7** For one hour the electric operated Low-Location Lighting (LLL system).

**1.2.8 For half an hour**

- a) all watertight doors which in accordance with the Rules for Machinery Installations (Pt.1, Vol.III), shall be power-operated, their controls and the stipulated indicating and warning devices in accordance with [Section 7, D.](#) (see also [1.4.2 b](#))
- b) the emergency equipment which brings the passenger lift cars to the next exit point for reasons of escape. If there are several passenger lift cars, they may in an emergency be brought to the exit point successive.

**1.3** For a ship which regularly makes voyages of limited duration, the national authorities may approve a shorter period than the 36 hours stipulated in [1.2.1](#) to [1.2.4](#), but not less than 12 hours, if in their opinion this ensures an adequate level of safety.

Dispensation to the reduced period of availability of the emergency source of power can be given to:

- a) Vessels with a class notation Coastal Service
- b) Vessels engaged in voyages where the route is no greater than 20 nautical miles offshore.

**1.4** The emergency source of electrical power for passenger ships may be either a generator set with a transitional source of emergency electrical power or a storage battery.

**1.4.1** If the emergency source of electrical power is a generator set it shall be powered by a suitable prime mover with its own independent fuel supply in accordance with the [Rules for Machinery Installations \(Pt.1, Vol.III\), Sec.10, B.](#) and an independent cooling system. The set shall start automatically if the main power supply fails. Supply to the consumers listed under [1.2](#) shall be taken over automatically by the emergency set.

The emergency electrical supply provisions shall be such that the rated load capacity is assured as quickly as possible but not later than 45 seconds after failure of the main power supply.

**1.4.2** The transitional emergency source of electrical power shall be a storage battery which in the case of failure of the main and emergency power supplies immediately supplies the consumers listed below, until the emergency generator set described under [1.4.1](#) is operative and connected.

Its capacity shall be so rated that it is capable, without recharging to supply the consumers for the period as specified below. During this period, its terminal voltage shall remain within  $\pm 12\%$  of the rated value.

The following consumers are to be taken into account, insofar as they depend on an electrical power source for their operation:

- 1) for half an hour, the lighting stipulated under [1.2.1](#) and [1.2.2 a](#)), lanterns and lights and all equipment stipulated under [1.2.3 a](#)), [1.2.3 c](#)) and [1.2.3 d](#)) insofar as these are not supplied independently by their own emergency storage battery during the stipulated period
- 2) power for closing the watertight doors without a requirement for simultaneous closure of all doors and for their indicating devices and warning signals, as stipulated under [1.2.8 a](#)).

**1.4.3** If the emergency source of electrical power is a storage battery it shall be capable in the event of failure of the main electrical power supply to take over automatically and immediately the supply to the consumers listed under [1.2](#) and of supplying them without a recharging for the stipulated period. During this period, its terminal voltage shall remain within  $\pm 12\%$  of the rated value.

**1.4.4** An indication of inadmissible battery discharge (emergency source of electrical power and transitional emergency electrical power source) shall be provided at the main switchboard or in the engine control room.

## **2. Power systems**

### **2.1 Steering gear**

On all passenger ships, full steering power shall be available even if one power unit is inoperative

### **2.2 Pressure water spraying systems (sprinkler)**

If an automatic electrically powered fire extinguishing and alarm system is provided, pumps and compressors shall each be supplied via direct cables from the main switchboard and from the emergency switchboard. Near the sprinkler system operating position is a changeover switch required which automatically switches to supply from the emergency switchboard if the main supply fails.

### **2.3 Fire pumps**

On passenger vessels of  $\geq 1000$  GT, one of the fire pumps shall start up automatically if the fire main pressure drops.

### **2.4 Fans**

**2.4.1** All motor fans, except for engine rooms and cargo space ventilation, shall be fitted with switching devices which are so arranged that all of the fans can optionally be stopped and switched on from two control positions located as far apart as possible. One of these positions shall be located on the bridge.

The switchgear provided for engine room power operated ventilators shall be controlled from two positions of which one shall be outside the engine room area.

Power-operated cargo room fans shall be capable of being switched off from a safe control position outside the spaces in question.

**2.4.2** The galley supply and exhaust fans shall additionally be capable of being stopped from a control position near the access-door to the galley.

### **2.5 Bilge pumps**

**2.5.1** See also [Rules for Machinery Installations \(Pt.1, Vol.III\), Sec. 11](#).

**2.5.2** If submerged bilge pumps are electrically driven, the cables from a position above the bulkhead deck to the motors shall be laid in one continuous length.

All electrical equipment in this area used for this purpose shall remain operative if the room is flooded to bulkhead-deck level.

**2.5.3** A fixed installed submerged bilge pump shall be capable of being started from a position above the bulkhead deck.

If additionally, a local starting device for the motor is provided, all control cables to this device shall be disconnected from a position near the starter above the bulkhead deck.

### **2.6 Cross-flooding arrangements**

Where closing devices are installed in cross-flooding arrangements, they shall be capable to be operated from the bridge or from a central position located above the bulkhead deck (see also [Rules for Hull \(Pt.1, Vol.II\), Sec. 26, J.](#) and [Rules for Machinery Installations \(Pt.1, Vol.III\), Sec. 11, P](#) and [7.1, H.](#)).

## D. Control, Monitoring and Ship's Safety Systems

### 1. Internal communication systems

#### 1.1 Voice communication for an emergency

1.1.1 An appropriate means of communication shall be provided which permits the transmission of commands between strategically important positions:

- Between quarter of assembly, the emergency control positions, the muster stations and the launching positions of the lifesaving appliances.
- Between the navigation bridge and the main fire control stations.
- Between the officer of the watch and person responsible for closing any watertight door which is not capable of being closed from a central control station.

1.1.2 This system may comprise portable or fixed equipment and shall remain operable even after failure of the main electrical power supply.

1.1.3 For portable systems at least 3 portable VHF transceiver shall be provided.

#### 1.2 Public Address system (PA-systems)

##### 1.2.1 General

The public-addresssystem shall enable simultaneous broadcast of messages to all spaces where crew members and/or passengers are normally present. This includes spaces where passengers or crew members assemble in case of emergency, i.e. muster stations.

It shall be possible to address crew accommodation and working spaces separately from passenger spaces.

The broadcast shall be possible from the navigation bridge, and at least one other location on board (i.e. muster station, boat embarking station).

By the broadcast from the navigation bridge other signals which can be broadcasted on this system shall be interrupted.

Additional to [Section 9, D.2.1](#) the public-address system shall also cover the open deck.

If the public-address system is used for the transmission of the general alarm, [2.](#) shall be observed additionally.

Functional proofs have to be provided at environmental conditions and EMC requirements according to the [Guidance for Approval and Type Approval of Materials and Equipment for Marine Use \(Pt.1, Vol.W\)](#).

##### **Note**

*With regard to EMC reference is made to IEC publications 60533 and 60945*

##### 1.2.2 System requirements

Voice communication stations of the system necessary for emergency shall fulfil the following requirements:

- 1) Controls for emergency functions shall be clearly indicated.
- 2) Controls shall be safe guarded against unauthorized use.
- 3) If operated any other broadcasts of other systems or programmes shall be automatically interrupted.
- 4) Operation from the control stations including the bridge shall automatically override all volume controls and on/off controls so that the required volume for the emergency mode is achieved in all spaces.

All areas of each fire zone shall be served by at least two independent loops. The supply shall be done by at least two independent amplifiers so that in case of failure of one amplifier or loop the broadcast is possible with reduced volume.

Amplifiers with multiple outputs may serve the loop of another fire zone provided the short-circuit of one output does not affect the other outputs.

### 1.2.3 Protection of loudspeaker loops

Short-circuits in loudspeakers shall not cause the loss of the complete loop.

This requirement is fulfilled, e.g. if each loudspeaker is supplied by an own transformer and a short-circuit of the secondary coil does not affect the operation of the remaining loudspeakers.

### 1.2.4 Supply of the amplifiers

Each amplifier shall be powered by an own power unit. The supply shall be provided from the main source of power, the emergency source of power and the transitional emergency source of power.

### 1.2.5 Installation

The panels of a PA-system shall be installed in a control station.

The system shall be arranged to minimize the effect of a single failure, e.g. by the use of multiple amplifiers with segregated cable routes.

The cables shall, as far as practicable, be routed clear of galleys, laundries, machinery spaces of category A and their walls and other areas with a high fire risk. Exempted are cables, which are serving those spaces. Where practicable, all the cables shall be run in such a way that they will not be impaired by the effects of a fire in an adjacent space separated by a bulkhead.

## 2. General emergency alarm

### 2.1 General

On all passenger vessels, an alarm system shall be provided by which the passengers and the crew can be warned or called to the quarters of assembly.

2.2 Selective fused supply circuits shall be laid in the individual fire zones.

2.3 The general emergency alarm shall be supplied from the main and emergency source of electrical power. If the emergency source of electrical power is a generator, the general emergency alarm shall be supplied additionally from the transitional emergency source of electrical power.

2.4 The alarm and the audible announcements in accordance with [Section 9, D.2.1](#) shall be both, separate for passengers and crew, and also together for them. The PA system shall be audible throughout the passenger and service area, the control and safety stations and on all open decks.

## 3. Fire detection and alarm on ships with pressure water spraying systems (sprinkler)

3.1 One of the following systems shall be provided for every separate vertical or horizontal fire zone in all accommodation and service rooms and insofar as necessary in all control stations, except in rooms which have no substantial fire risk, such as void spaces, sanitary rooms etc.:

- 1) a fixed installed fire detection and alarm system, so installed and arranged as to detect every fire in these spaces, or
- 2) an automatic sprinkler, fire detection and fire alarm system, see [Rules for Machinery Installations \(Pt.1, Vol. III\), Sec. 12, L.](#)

3.2 An automatic sprinkler, fire detection and fire alarm system shall be installed in all service rooms, control stations and accommodation spaces including the passageways and stairs, see the [Rules for Machinery Installations \(Pt.1, Vol. III\), Sec. 12, L.](#)

#### 4. Fire detection systems

**4.1** All accommodation and service rooms, enclosed staircases and passageways shall be equipped with a smoke detection and alarm system. Exempted are sanitary rooms and areas constituting no substantial fire risk e.g. void spaces and similar areas.

In galleys, heat detectors may be fitted instead of smoke detectors or equivalent detectors.

Heat detectors are acceptable in refrigerated chambers and in other spaces where steam and fumes are produced such as saunas and laundries. Refrigerated chambers may be fitted with dry pipe sprinkler systems<sup>2)</sup>.

Smoke detectors shall be fitted above suspended ceilings in staircases and passageways and in areas where ceilings are made of combustible materials. The distances between the detectors shall correspond with [Section 9, D.3.1.16](#), if no smaller distances are necessary due to reduced air circulation.

**4.2** Apart from the smoke detectors required for passageways, staircases and escape routes, other approved automatic fire detection devices may also be used in the accommodation and day rooms.

**4.3** The individual detection loops in the accommodation shall not cover more than 50 enclosed rooms with a maximum of 100 detectors.

**4.4** Fire detection and fire alarm systems shall be capable of remotely and individually identifying each detector and manually operated call point.

**4.5** Detectors fitted in cabins, when activated, shall also be capable of emitting, or cause to be emitted, an audible alarm within the space where they are located.

**4.6** The monitored region of fire detection systems may simultaneously contain rooms on both sides of the ship and on several decks. However, all these shall be located in the same main vertical fire zone.

**4.7** If manually operated fire call points are not sufficiently illuminated by a nearby installed emergency light, they shall be provided with a guide light.

**4.8** Special spaces such as cargo rooms and car decks on Ro-Ro vessels for transportation of motor vehicles with fuel in their tanks, and non-accessible cargo rooms, shall be equipped with an approved automatic fire detection and alarm system, see [Section 16, D](#).

If in accordance with SOLAS special category spaces are continuously watched by a fire patrol, such spaces are only to be equipped with manually operated fire alarm call points.

The manually operated call points shall be distributed in sufficient quantity over the spaces and at every exit from these spaces.

**4.9** In accordance with the Fire Safety Systems Code (FSS Code) Chapter 9 a fixed fire detection and fire alarm system shall be installed on cabin balconies where furniture and furnishings other than those of restricted fire risk (flame retardant) are used.

Passenger ships constructed before 1 July 2008 shall comply with the requirements of this paragraph by the first survey after 1 July 2008.

**4.10** According to [Section 9, D](#). described requirements for fire detection and fire alarm systems, additional influences shall be observed on fire detections for cabin balconies:

- wind conditions
- sun irradiation
- ultraviolet exposure

**4.10.1** Type approved detectors shall be operated by heat, smoke flame or any combination of these factors. Other detectors can be used where the evidence of suitability is demonstrated by a type approval.

<sup>2)</sup>Applicable For passenger ships carrying more than 36 passengers.

## 5. Fire door's closing system

5.1 Rules for Machinery Installations (Pt.1, Vol. III), Sec. 14, G. shall be observed.

5.2 Electrical power shall be supplied from the emergency electrical power supply.

5.3 Address units of a fire zone shall be combined to one loop, if the control and/or the display of a fire door work on an address unit of the fire alarm system.

Fire resistant cables shall be used, if the display on the bridge works on this address unit.

## 6. Fire door's closure indication

6.1 For all fire doors in main vertical zone bulkheads, galley boundaries and stairway enclosures an indication shall be provided at an indicator panel in a continuously manned control station whether each of the remote-released doors are closed.

6.2 Electrical power shall be supplied from the emergency electrical power supply.

## 7. Watertight doors

7.1 Rules for Machinery Installations (Pt.1, Vol. III), Sec. 14, F.5. shall be observed

7.2 Electrical equipment shall as far as possible be installed above the bulkhead deck and outside of hazardous areas.

If electrical components are installed below the bulkhead deck, their protection against water shall have the following minimum degree:

- 1) electric motors, associated circuits and monitoring equipment: IP X7
- 2) door indicators and associated components: IP X8.
- 3) The water pressure test shall be based on the pressure that may built-up at the place of installation during flooding
- 4) warning devices activated when the door closes: IP X6

7.3 The power supply to the drives of the water-tight doors and to their associated control and monitoring equipment shall be provided either directly from the emergency switchboard or from a sub-distribution panel located above the bulkhead deck and supplied from the emergency switchboard.

If the emergency electrical power supply is assured by a generator unit, the system shall be supplied for 30 minutes by the transitional emergency source of electrical power. During the period of supply from this source, there is no need to close all the doors simultaneously provided all doors can be closed within 60 seconds.

7.4 Power-operated watertight doors shall be in case of electrical outfit and motor drive independent of each other and with their own power supply for opening and closing.

In case of main or emergency electrical power supply failure the supply shall be automatically maintained from the transitional source of emergency electrical power, and with sufficient capacity to operate the door three times (closing-opening-closing).

7.5 Failure of a power supply shall cause an optical and audible alarm in the central control station on the bridge.

7.6 A single fault in the electrical power supply or in the control system of a power-operated door shall not cause a door opening.

7.7 A single fault in the control unit of a power-operated drive, except in the closing hydraulic cylinder or in similar part shall not impair the working clearness of the manual operation.

**7.8** The operating console on the bridge shall be provided with a system schematic from which the arrangement of the watertight doors in the ship can be recognized. Indicating lights shall be provided showing whether a door is open or closed.

A red indicating light shall inform that the subject door is completely open and a green light, that it is completely closed.

If the door is in an interposition, e.g. still travelling this shall be indicated by the red indicating light blinking. The monitoring circuits shall be independent of the control circuits of the individual doors.

**7.9** An opening of the watertight doors by central remote control is not permitted.

**7.10** The electrical controls, indicators and the possibly necessary power supply shall be so structured and fused that any fault in the electrical system of one of the doors does not impair, the functioning of other doors.

A short-circuit and other faults in the alarm or indicating circuit of a door shall not result in a failure of the power-operated drive of this door

Entry of water into the electrical equipment of a door below the bulkhead deck shall not cause this door to open.

## **8. Indicating and monitoring systems for shell doors**

For Ro-Ro passenger vessels, see [Section 16, E](#).

## **9. Continuously manned control station**

**9.1** The following alarms, indications and controls shall be provided in a continuously manned control station:

**9.1.1** Alarm, release of sprinklers, fire alarm

**9.1.2** Controls for fire doors closures

**9.1.3** Controls for shut down and switch-on of fans and indication of their status on/off

**9.2** Alarms shall be designed on the closed-circuit principle

**9.3** Where auxiliary supply is required for the indications according to [9.1.2](#) and [9.1.3](#), this supply shall be realised by the main source of power and the emergency source of power with automatic switch over in case of failure of the main source of power.

## **10. Flooding detection system**

**10.1** A flooding detection system for watertight spaces below the bulkhead deck shall be provided for passenger ships carrying 36 or more persons and constructed on or after 1 July 2010 as defined in SOLAS, Chapter II-1, Regulation 22-1.

**10.2** The flooding detection system sensors and associated equipment are subject to mandatory type approval.

### **10.3 Definitions**

**10.3.1** Flooding detection system means a system of sensors and alarms that detect and warn of water ingress into watertight spaces. Continuous flood level monitoring may be provided, but is not required.

**10.3.2** Sensor means a device fitted at the location being monitored that activates a signal to identify the presence of water at the location.

**10.3.3** Alarm means an audible and visual signal which announces a flooding condition requiring attention.

### **10.4 System installation**

**10.4.1** A flooding detection system shall be fitted in all watertight spaces below the bulkhead deck that:

- have a volume [ $m^3$ ], that is more than the ship's moulded displacement [cm] immersion at deepest subdivision draught; or
- have a volume more than  $30 m^3$ , whichever is the greater.

**10.4.2** Any watertight spaces that are separately equipped with a liquid level monitoring system (such as fresh water, ballast water, fuel, etc.), with an indicator panel or other means of monitoring at the navigation bridge (and the safety centre if located in a separate space from the navigation bridge), are excluded from these requirements.

## **10.5 Sensor installation**

**10.5.1** The number and location of flooding detection sensors shall be sufficient to ensure that any substantial water ingress into a watertight space requiring a flooding detection system is detected under reasonable angles of trim and heel. To accomplish this, flooding detection sensors required in accordance with item 10.4.1 should generally be installed as indicated below:

- Vertical location – sensors should be installed as low as practical in the watertight space.
- Longitudinal location – in watertight spaces located forward of the mid-length, sensors should generally be installed at the forward end of the space; and in watertight spaces located aft of the midlength, sensors should generally be installed at the aft end of the space. For watertight spaces located in the vicinity of the mid-length, consideration should be given to the appropriate longitudinal location of the sensor. In addition, any watertight space of more than  $L_s/5$  ( $L_s$  subdivision length) in length or with arrangements that would seriously restrict the longitudinal flow of water should be provided with sensors at both the forward and aft ends.
- Transverse location – sensors should generally be installed at the centreline of the space (or alternatively at both the port and starboard sides). In addition, any watertight space that extends the full breadth of the ship or with arrangements that would seriously restrict the transverse flow of water should be provided with sensors at both the port and starboard sides.

**10.5.2** Where a watertight space extends in height over more than one deck, there shall be at least one flooding detection sensor at each deck level. This is not applicable in cases where a continuous flood level monitoring system is installed.

## **10.6 Unusual arrangements**

**10.6.1** For watertight spaces with unusual arrangements or in other cases where this requirement would not achieve the intended purpose, the number and location of flooding detection sensors should be subject to special consideration.

## **10.7 Alarm installation**

**10.7.1** Each flooding detection system should give an audible and visual alarm at the navigation bridge and the safety centre, if located in a separate space from the navigation bridge. These alarms should indicate which watertight space is flooded.

**10.7.2** Visual and audible alarms should conform to the Code on Alerts and Indicators, 2009, as amended, as applicable to an alarm for the preservation or safety of the ship.

## **10.8 Design requirements**

**10.8.1** The flooding detection system and equipment shall be suitably designed to withstand supply voltage variation and transients, ambient temperature changes, vibration, humidity, shock, impact and corrosion normally encountered in ships. Sensor cabling and junction boxes shall be suitably rated to ensure operability of the detection system in a flooded condition. In addition, the detection system shall be designed on the fail-to-safety principle, where an open sensor circuit shall result in an alarm condition.



**10.8.2** The flooding detection system shall be supplied from the emergency and main source of electrical power. Each failure of the power supply shall be alarmed visually and audibly.

### 10.9 Detector maintenance, accessibility and testing

**10.9.1** Documented operating, maintenance and testing procedures for the flooding detection system shall be kept on board and be readily accessible.

**10.9.2** Flooding detection system sensors and associated equipment shall be installed where they are accessible for testing, maintenance and repair.

**10.9.3** The flooding detection system shall be capable of being functionally tested using either direct or indirect methods. Records of testing shall be retained on board.

## E. Lighting

### 1. Low-location lighting (LLL) systems

**1.1** In passengers' and crews' accommodation all escape routes including stairs and exits shall be provided at all points on the route including the corners and intersections with electrically operated or photo luminescent low-location lighting. The low-location lighting shall enable the passengers and crew to identify all escape routes and to recognize the emergency exits easily.

**1.2** Electrically supplied LLL-systems are subject to mandatory type approval.

**1.3** Electrical power shall be supplied from the emergency switchboard and shall be redundant arranged for each fire zone either by the use of fire-resistant cables or by local batteries including their chargers able to ensure an operation for at least 60 minutes in case of supply failure. Example for supply, see Fig. 14.1.

**1.4** The LLL-system shall be connectable from the permanent manned control station.

**1.5** The LLL-system shall be installed not more than 0,3 metre above the deck and not more than 0,15 metre distant from walls. Where a corridor or stair exceeds 2 metres in width a low location lighting shall be installed at both sides.

**1.6** The design of the low-location lighting systems shall be made in accordance with the technical requirements of IMO Resolution A. 752(18) and MSC/Circ.1167.

### 2. Additional emergency lighting for Ro-Ro passenger vessels

Ro-Ro passenger vessels shall be provided with an additional emergency lighting, see Section 16, F.

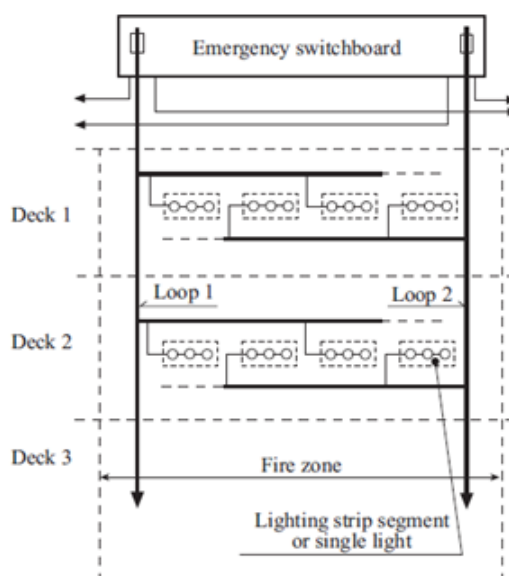

Figure 14.1: Specimen of supply layout-low- location lighting

### 3. Lighting system

**3.1** If a ship is subdivided into main fire zones in accordance with SOLAS, at least two electric circuits, each of them with its own supply cable shall be provided for the lighting in each main fire zone. One circuit may be supplied from the emergency switchboard if this is continuously supplied. The supply cables shall be so arranged that in the event of a fire in one main fire zone the lighting is maintained in the other zones.

**3.2** Supplementary lighting shall be provided in all cabins to clearly indicate the exit so that occupants will be able to find their way to the door. Such lighting, which may be connected to the emergency source of power or have a self-contained source of electrical power in each cabin, shall automatically illuminate when power to the normal cabin lighting is lost and remain on for a minimum of 30 min.

**Note:**

*May be switched-off if the main lighting is available.*

## F. Cable Network

### 1. Routing of cables

On passenger ships, the main and emergency supply cables which have to be run through a common vertical main fire zone shall be laid as far apart as practicable so that, in the event of a fire in this main fire zone, supply cables passing through to main and emergency equipment in other vertical and horizontal main fire zones remains, as far as possible, unaffected.

### 2. Selection of cables

**2.1** In areas attended by passengers and in-service areas only halogen-free cables shall be used for permanent installations. Cable trays/protective casings made of plastic materials as well as mounting materials shall be halogen-free as well.

Exceptions for individual cables for special purposes have to be agreed with BKI.

**2.2** For all other areas of the ship, the use of halogen-free cables is recommended

## Section 15 Additional Rules for Tankers

A.	General . . . . .	15-1
B.	Oil Tankers, Cargo Flash Point above 60 °C . . . . .	15-3
C.	Oil Tankers, Cargo Flash Point 60 °C or below . . . . .	15-3
D.	Liquefied Gas Tankers . . . . .	15-4
E.	Chemical Tankers . . . . .	15-4

### A. General

#### 1. Scope

These Rules apply additionally to electrical equipment on tankers for the carriage of liquids developing combustible gases or vapours.

#### 2. References to other Rules and Regulation

2.1 [Section 1, K.3](#)

2.2 [Rules for Hull \(Pt.1, Vol.II\)](#)

2.3 [Rules for Machinery Installations \(Pt.1, Vol.III\)](#)

2.4 [Rules for Ship Carrying Liquefied Gases in Bulk \(Pt.1, Vol.IX\)](#), see also IGC Code of IMO

2.5 [Rules for Ship Carrying Dangerous Chemical in Bulk \(Pt.1, Vol.X\)](#), see also IGC Code

2.6 IEC 60092-502

2.7 SOLAS

#### 3. Hazardous areas

3.1 Hazardous areas in which protective measures are mandatorily required are specified in B and C and in IEC 60092-502 and [Rules for Ship Carrying Liquefied Gases in Bulk \(Pt.1, Vol. IX\)](#) and [Rules for Ship Carrying Dangerous Chemical in Bulk \(Pt.1, Vol.X\)](#), and IBC-Code.

3.2 Areas on open deck, or semi-enclosed spaces on open deck, within 3 metres of cargo tank ventilation outlets which permit the flow of small volumes of vapour or gas mixtures caused by thermal variation are defined as Zone 1. Areas within 2 metres beyond the zone specified above are to be considered as Zone 2.

#### 4. Power supply systems

4.1 The following power supply systems are permitted:

4.1.1 Direct current and single-phase alternating current:

- 2 conductors, insulated from ship's hull

4.1.2 Three-phase alternating current:

- 3 conductors, insulated from ship's hull

4.2 Systems with hull return, or systems with earthed neutral, or systems with earthed conductor are not permitted, except for locally limited hull return or neutral earthed systems which are located outside of hazardous areas for

- active corrosion protections
- measuring circuits of starting and preheating systems of internal combustion systems
- medium voltage systems without influence of hazardous areas (see [Section 8, C.](#))

4.3 The insulation resistance of non-earthed primary or secondary distribution systems passing through hazardous areas, or belonging to equipment in a hazardous area, shall be continuously monitored. Earth faults shall be alarmed (see [Sections 5, E.](#) and [Sections 20, E.](#)).

## 5. Cable installation

5.1 In hazardous areas, cables shall be laid only for equipment whose use is permitted in these areas; cables related to other requirements of this Section may also pass through these areas. Cables shall be reliably protected against damage.

5.2 All cables liable to be exposed to the cargo, oil vapours or gases shall be armoured or shielded, and must have an overall watertight and oil-resistant outer sheath.

5.3 Each intrinsically safe system shall have its own separate cable. It is not permissible for intrinsically safe and non-intrinsically safe circuits to lay these together in a cable bundle or pipe or to mount them under common clamps (see [Section 12, C.5.7](#)). Intrinsically safe cables shall be marked.

## 6. Electrical equipment in hazardous areas (zone 0 and 1) and extended hazardous areas (zone 2)

6.1 In principal electrical equipment of non-certified safe-type shall be installed outside of hazardous areas. Such equipment may be installed in enclosed or semi-enclosed rooms only if these are well ventilated and separated by cofferdams or equivalent spaces from the cargo tanks, and by oil-tight and gas-tight bulkheads from cofferdams and cargo pump rooms. These rooms shall be accessible only from a non-hazardous area or through adequately ventilated air locks.

Electrical equipment of non-certified safe-type may be installed inside hazardous areas, if it belongs to an intrinsic safe circuit.

6.2 The use of electrical equipment in hazardous areas shall be restricted to necessary required equipment.

6.3 The explosion types of electrical equipment in hazardous areas shall be as mentioned

- in [Section 1, K. 3.2](#) for Zone 0,
- in [Section 1, K. 3.3](#) for Zone 1,
- in [Section 1, K. 3.4](#) for Zone 2

and their explosion group and temperature class shall conform with the characteristics of the cargo.

### 6.4 Motors

In case of motors with an explosion protection type Ex e (increased safety) these motors must be equipped with protective devices for over current which shut-off the motors, if the winding temperatures rise to unacceptable high levels. Monitoring of the winding temperature does not replace the motor over current protection in the motor switchgear, which is required in all cases.

### 6.5 Measuring, signalling, control and intercommunication circuits

6.5.1 According to the classified hazardous area the construction types Ex ia or Ex ib shall be preferred.

**6.5.2** The suitability of the systems for tank level gauging, tank pressure monitoring systems, high level alarm, overflow control and for required gas detection shall be proved by a BKI type approval test, see [Section 21, E.5.6](#).

## **7. Fans and ventilation**

**7.1** Fans intended for installation in hazardous areas shall be designed according to the [Rules for Machinery Installations \(Pt.1, Vol.III\), Sec. 15, B.5.3](#).

**7.2** Requirements for ventilation, see Regulations for Ventilation System on Board Seagoing Ships.

## **8. Integrated cargo and ballast systems**

**8.1** If the operation of cargo and/or ballast system is necessary under certain emergency circumstances or during navigation to ensure the safety of the tanker, measures are to be taken to prevent cargo and ballast pumps becoming inoperative simultaneously due to a single failure including its control and safety system.

**8.2** The emergency stop of the cargo and ballast systems are to be independent from the control circuits. A single failure in the control or emergency stop circuits shall not lead to an inoperative cargo and ballast system.

**8.3** Manual emergency stops of the cargo pumps shall not make the ballast pumps inoperable.

**8.4** The control system is to be provided with a backup power supply, which may be a second power supply from main switch board. A failure of any power supply shall cause an alarm, audible and visible at each control panel location.

**8.5** In the event of a failure of the automatic or remote-control systems, a secondary means of control shall ensure the operation of the cargo and ballast system. This shall be achieved by manual overriding and/or redundant arrangements within the control systems.

## **9. Active cathodic protection systems**

**9.1** Metallic parts in hazardous areas shall not be provided with impressed current cathodic protection, unless specially designed and accepted by the authority.

**9.2** Cables for active corrosion protection systems, see [Section 1, K.3.3.3](#)

## **B. Oil Tankers, Cargo Flash Point above 60 °C**

**1.** Where the cargoes are heated to a temperature within 10 °C of their flash point or above, the requirements of [C](#). are applicable.

**2.** Where the cargoes are not heated or heated to not more than 10 °C below its flash point, extended hazardous areas (zone 2) are specified inside cargo tanks, slop tanks and any pipework for cargo and slop tanks or venting systems.

**2.1** To avoid possible sources of ignition, the following protective measures shall be applied:

**2.1.1** Electrical equipment, necessary to install in zone 2 spaces shall be of types mentioned in [Section 1, K.3.4.2](#)

**2.1.2** Cables must not be laid inside of cargo tanks. Exceptions are made for cables leading to essential equipment located in the tanks. The cables shall be installed in thick-walled, gastight pipes up to a point above the main deck.

## **C. Oil Tankers, Cargo Flash Point 60 °C or below**

### **1. Hazardous areas zone 0 and permitted electrical equipment**

**1.1** Hazardous areas (zone 0) are specified in IEC 60092-502, item 4.2.1

1.2 Electrical equipment, necessary to install in zone 0 spaces shall be of types mentioned in [Section 1, K.3.2.2](#)

## 2. Hazardous areas zone 1 and permitted electrical equipment

2.1 Hazardous areas (zone 1) are specified in IEC 60092-502 item 4.2.2

2.2 Electrical equipment, necessary to install in zone 1 spaces shall be of types mentioned in [Section 1, K.3.3.2](#)

## 3. Extended hazardous areas zone 2 and permitted electrical equipment

3.1 Extended hazardous areas (zone 2) are specified in IEC 60092-502 item 4.2.3

3.2 Electrical equipment, necessary to install in zone 2 spaces shall be of types mentioned in [Section 1, K.3.4.2](#)

## D. Liquefied Gas Tankers

Special requirements see [Rules for Ship Carrying Liquefied Gases in Bulk \(Pt.1, Vol.IX\)](#), see also IGC Code of IMO.

## E. Chemical Tankers

Special requirements see [Rules for Ship Carrying Dangerous Chemical in Bulk \(Pt.1, Vol.X\)](#), see also IGC Code of IMO.

## Section 16 Additional Rules for Ships for the Carriage of Motor Vehicles

A.	Scope . . . . .	16-1
B.	Protection Areas . . . . .	16-1
C.	Ventilation . . . . .	16-1
D.	Fire Alarm System . . . . .	16-2
E.	Indicating and Monitoring Systems for Shell Doors . . . . .	16-2
F.	Additional Requirements for the Illumination on Ro-Ro Passenger Vessels . . . . .	16-3
G.	Installation of Electrical Equipment in Protection Areas . . . . .	16-4
H.	Permissible Electrical Equipment . . . . .	16-4
I.	Requirements for Spaces intended for Carriage of Motor Vehicles with compressed Natural Gas in their Tanks for their own Propulsion as Cargo . . . . .	16-6

### A. Scope

These Rules apply additionally to electrical equipment on cargo and passenger ships for the transportation of motor vehicles which are driven on and off the ship by their built-in drives and/or have fuel in their tanks (Ro-Ro-ships).

### B. Protection Areas

Protection areas (zone 1) are areas in which an explosive atmosphere can be expected to be present occasionally (see Fig 16.1). Such zones include the following:

#### 1. Passenger ships

1.1 Closed vehicle decks above the bulkhead deck (at least 10 air changes/hour) up to a height of 450 mm. The spaces above grating vehicle decks with adequate permeability are not deemed to be protection areas.

1.2 Vehicle decks below the bulkhead deck extending to the full height.

1.3 Holds for motor vehicles.

1.4 Exhaust ducts from holds and vehicle decks.

#### 2. Cargo ships

2.1 Closed vehicle decks extending to the full height (with < 10 air changes/hour), or closed vehicle decks to a height of 450 mm (with ≥ 10 air changes/hour). Spaces above grating vehicles decks with adequate permeability are not deemed to be protection zones.

2.2 Exhaust ducts from holds and vehicle decks.

### C. Ventilation

1. A forced-draught ventilation system is required to ensure a sufficient number of air changes during the loading, unloading and transportation of motor vehicles. For details, see [Rules for Machinery Installations \(Pt.1, Vol.III\), Sec. 12, B.11.](#)

2. On passenger ships, a fan failure <sup>1)</sup> or failure related to the number of air changes specified for vehicle decks and holds shall be alarmed on the bridge.
3. On cargo ships, a fan failure <sup>1)</sup> shall be alarmed on the bridge.
4. It shall be possible to switch ventilation systems on and off from a position outside the ventilated car decks or holds. Provision shall be made for the immediate shut-down and closure of the systems in the event of fire.

#### D. Fire Alarm System

1. Unless enclosed car decks on passenger ships are under the supervision of a fire patrol during the transportation of vehicles, an automatic fire alarm system is required for these areas. The design of the system shall comply with the requirements set out in [Section 9, D.](#) and [Rules for Machinery Installations \(Pt.1, Vol.III\), Sec. 12, C.](#)

A sufficient number of manually operated call points shall be installed in the areas mentioned above. One call point shall be located close to each exit.

2. Cargo holds for the carriage of vehicles with fuel in their tanks, and vehicle decks on cargo ships, shall be equipped with automatic fire alarm systems. The extent and execution of these systems shall conform to [Section 9, D.](#) and [Rules for Machinery Installations \(Pt.1, Vol.III\), Sec. 12, C.](#)

#### E. Indicating and Monitoring Systems for Shell Doors

The following additional monitoring systems and indicators shall be provided on the bridge (see also [Rules for Hull \(Pt.1, Vol.II\), Sec. 6, H and J.](#))

##### 1. Bow doors and inner doors

**1.1** Bow doors and inner doors giving access to vehicle decks shall be equipped for remote operation from above the freeboard deck to enable the following

- closing and opening of the door and
- operation of the locking and securing devices.

An indication of the open/closed position of each locking and securing device shall be provided at the remote-operating position. The operating consoles serving the doors shall be accessible only to authorised personnel. A notice drawing attention to the fact that all locking devices shall be locked and secured before leaving harbour shall be fitted at every operating console. Furthermore, appropriate warning indicator lights shall be provided.

**1.2** Indicator lights shall be provided on the bridge and at the operating console for indication that the bow door and the inner door are closed and the locking and securing devices are in their correct positions. Deviations from the correct closed condition shall be indicated by optical and audible alarms.

The indicator panel shall be provided with

- a power failure alarm,
- an earth failure alarm,
- a lamp test and
- separate indication for door closed, door locked, door not closed, and door not locked

A lamp test shall be provided for the indicating lights.

Switching the indicating lights off is not permitted.

---

<sup>1)</sup>Monitoring of motor-fan switching devices is sufficient

<sup>1)</sup>Monitoring of motor-fan switching devices is sufficient



1.3 The indicating-system shall be self-monitored and shall provide optical and audible alarms if the doors are not completely closed and secured or the locking devices changes to the open position or the securing devices become untight. The power supply to the indicating-system shall be independent of that for opening and closing the doors and is to be provided with a backup power supply from the emergency source or secure power supply e.g. UPS. The sensors of the indicating-system shall be protected against water, icing-up and mechanical damage (minimum degrees of protection IP 56).

1.4 The indicating-equipment on the bridge shall have a "Harbour/Sea" selector switch which initiates an alarm if the ship leaves the harbour with the bow or inner door not properly closed or with securing devices not in the correct position.

1.5 A leakage-water monitoring system with audible alarm and television-supervision shall be provided which indicates on the bridge and in the machinery control room if water is leaking through the inner door.

1.6 The space between bow door and inner door shall be provided with television-supervision and with monitors on the bridge and in the machinery control room. This supervision shall cover the position of the door and an adequate number of its locking and securing devices. Special attention shall be paid here to the illumination and the contrasts of the objects to be monitored.

1.7 A drain system shall be provided between the bow door and the ramp. The same applies to the space between ramp and inner door with a corresponding arrangement. If the water level in this space reaches a height of 0,5 metre above vehicle-deck level, an audible alarm shall sound on the bridge.

## 2. Side shell doors and stern doors

2.1 These requirements apply to side doors behind the collision bulkhead and to stern doors giving access to enclosed areas.

2.2 The requirements set out in items 1.2, 1.3 and 1.4 also apply analogously to those doors which give access to special-category areas and Ro-Ro areas, as defined in Regulation 3 of SOLAS Chapter II-2, as these areas could be flooded through these doors.

These requirements apply also for side shell doors on cargo vessels, if the opening of a door exceeds 6 m<sup>2</sup> in size and for side shell doors below 6 m<sup>2</sup> in size where the sill of any side shell door is below the uppermost load line.

2.3 On passenger ships a leakage monitoring system with an audible alarm and television supervision shall be provided which indicates on the bridge and in the machinery control room any leakage through these doors. On cargo ships a leakage monitoring system with an audible alarm shall be provided with an announcement on the bridge.

3. The following additional measures are required on passenger ships:

3.1 Indicators for all closed fire doors leading to the vehicle decks shall be provided on the bridge.

3.2 Special-category areas and Ro-Ro cargo rooms shall either be included in the fire-rounds or be monitored by effective means such as television supervision, so that while the ship is under way any movement of the vehicles in heavy weather or un-authorized access by passengers can be watched.

## F. Additional Requirements for the Illumination on Ro-Ro Passenger Vessels

### 1. Additional emergency luminaires

1.1 For emergency illumination in all rooms and passageways intended for passengers, except the cabins, additional emergency luminaires with integral batteries shall be provided.

Should all other sources of electrical power fail, access to the escape routes shall be easily recognisable.

The battery-powered luminaires shall as far as practicable be supplied from the emergency switchboard.

1.2 If all other sources of electrical power fail these additional emergency luminaires shall remain operable for at least 3 hours regardless of their attitude. The power source for this luminaire shall be a continuously-charged battery placed inside each luminaire.

The service life of the batteries, taking into account the respective operating conditions, shall be stated by the maker.

A failure of a luminaire shall be immediately recognisable.

1.3 All corridors of the crew's accommodation, the day rooms and usually manned workrooms are each to be provided with a portable, rechargeable battery-contained luminaire unless there is illumination provided in accordance with 1.1.

## 2. Low Location Lighting (LLL)-System.

2.1 Low location lighting shall be provided, see [Section 14, E](#).

2.2 The additional emergency luminaires required acc. to 1. May be fully or partly integral part of the LLL-system provided the additional requirements acc. to 1. are complied with.

## G. Installation of Electrical Equipment in Protection Areas

1. On principle, the amount of electrical equipment installed shall be restricted to installations necessary for operation.

2. All electrical equipment shall be permanently installed.

3. Movable consumers or equipment supplied via flexible cables shall only be used with special permission or operated when there are no vehicles on board.

4. Cables shall be protected against mechanical damage by covers.

Cables running horizontally are not permitted in the protection area extending to 45 cm above the enclosed vehicle deck.

## H. Permissible Electrical Equipment

1. Inside of the protection area (zone 1)

1.1 Electrical equipment shall be of a certified safe type with Explosion Group IIA and Temperature Class T3.

1.2 Certified safe type equipment in accordance with [Section 1, K.3.3.2](#) is permitted.

2. Above the protection area (zone 2)

2.1 Equipment in accordance with [Section 1, K.3.4.2](#) is permitted; the surface temperature shall not exceed 200 °C.

2.2 Ventilation openings on open deck within 1 metre surrounding for natural ventilation or 3 metres surrounding for forced ventilation for rooms belonging to areas of zone 2, see [Fig. 16.1](#)

Passenger ship

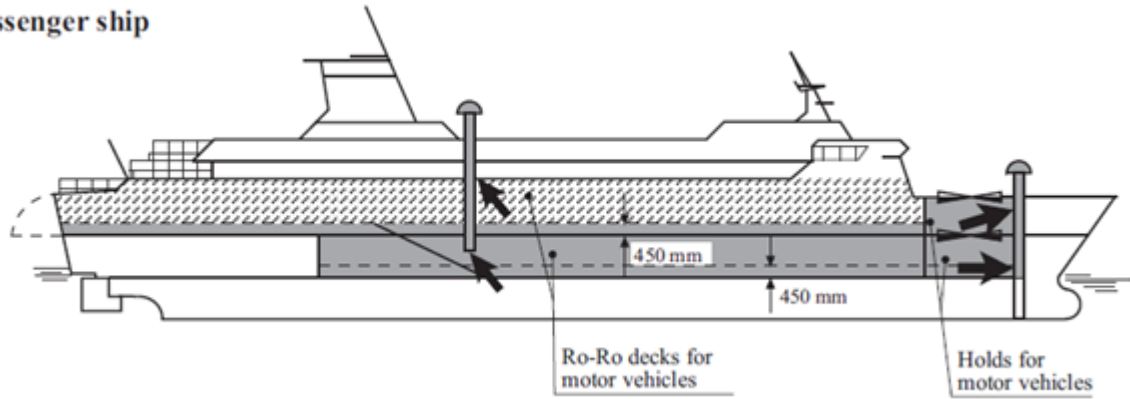

Ro-Ro cargo ship

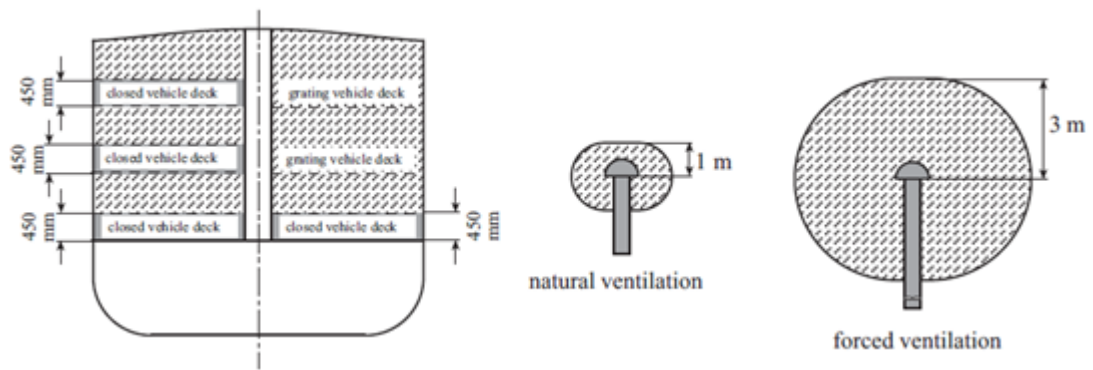
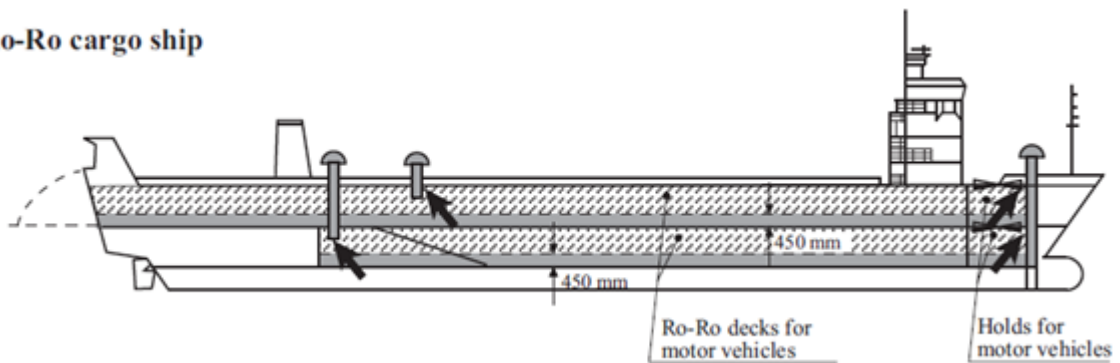

Ro-Ro decks for motor vehicles

Zones	Equipment design
above protection zone (zone 2)	IP 55 in conjunction with 10 changes of air per hour in the hold (see Section 1,K.3.4)
protection zone (zone 1)	certified safe type equipment (see Section 1,K.3.3)

Figure 16.1: Examples of protection areas on vehicle decks and in holds for the carriage of motor vehicles which are driven on and off the ship by their built-in drives and/or carry fuel in their tanks

## **I. Requirements for Spaces intended for Carriage of Motor Vehicles with compressed Natural Gas in their Tanks for their own Propulsion as Cargo**

### **1. Electrical equipment and wiring**

All electrical equipment and wiring shall be of a certified safe type for use in an explosive methane and air mixture<sup>2)</sup>.

### **2. Ventilation arrangement**

**2.1** Electrical equipment and wiring, if installed in any ventilation duct, shall be of a certified safe type for use in explosive hydrogen and air mixtures and the outlet from any exhaust duct shall be sited in a safe position, having regard to other possible sources of ignition.

**2.2** The fans shall be designed such as to avoid the possibility of ignition of hydrogen and air mixtures. Suitable wire mesh guards shall be fitted over inlet and outlet ventilation openings.

### **3. Other ignition sources**

Other equipment which may constitute a source of ignition of hydrogen and air mixtures shall not be permitted.

### **4. Detection**

When a vehicle carrier carries as cargo one or more motor vehicles with compressed hydrogen in their tanks for their own propulsion, at least two portable gas detectors shall be provided. Such detectors shall be suitable for the detection of the gas fuel and be of a certified safe type for use in the explosive gas and air mixture.

---

<sup>2)</sup>Refer to the recommendations of the International Electrotechnical Commission, in particular, publication IEC 60079

## Section 17 Additional Rules for Ships for the Carriage of Dangerous Goods

A.	Scope . . . . .	17-1
B.	References to other Rules . . . . .	17-1
C.	Classes of Dangerous Goods . . . . .	17-1
D.	Hazardous Areas and Permitted Electrical Equipment . . . . .	17-2
E.	Installation of Electrical Systems in Hazardous Areas . . . . .	17-6
F.	Certification if Installations Not Conform to the above Provisions . . . . .	17-6
G.	Fire Pumps . . . . .	17-7
H.	Alternative Electrical Power Supply for Ships Intended for the Carriage of Packaged Irradiated Nuclear Fuel, Plutonium and High-level Radioactive Wastes . . . . .	17-7

### A. Scope

These Rules apply to the electrical installations on ships with cargo spaces intended for the transportation of dangerous goods, except for liquids and gases carried in bulk (tankers).

### B. References to other Rules

1. SOLAS, Chapter II-2, Regulation 19, "Special Requirements for Ships Carrying Dangerous Goods"
2. SOLAS, Chapter VII, "Carriage of Dangerous Goods"
3. "International Maritime Solid Bulk Cargoes Code" (IMSBC Code)
4. "International Maritime Dangerous Goods Code" (IMDG Code)
5. [Rules for Machinery Installations \(Pt.1, Vol.III\) Sec. 12, P. and Q.](#)
6. IEC publication 60092-506

### C. Classes of Dangerous Goods

The dangerous goods for which safety measures regarding the electrical equipment are required are committed in SOLAS, Chapters II-2 Reg. 19, IMDG Code and IMSBC Code and they are divided into the following classes:

#### 1. Dangerous goods in packaged form

- |               |   |
|---------------|---|
| Class 1.1-1.6 | Explosive materials, except for goods of class 1 in division 1.4, compatibility group S (IMDG Code)         |
| Class 2.1     | All flammable gases, compressed, liquefied or dissolved under pressure                                      |
| Class 2.3     | All toxic gases having a subsidiary risk Class 2.1  |
| Class 3       | All flammable liquids with a flash point below 23 °C (closed-cup test)                                      |
| Class 4.3     | Substances in liquid form from which, in contact with water, emit flammable gases with a flash point <23 °C |
| Class 6.1     | All poisonous (toxic) substances with a flash point <23 °C (closed-cup test)                                |
| Class 8       | All corrosive substances with a flash point <23 °C (closed-cup test)  |
| Class 9       | Miscellaneous dangerous substances and articles evolving flammable vapours                                  |

## 2. Solid dangerous goods in bulk

- Class 4.1 Flammable solid substances
- Class 4.2 Substances liable to self-ignition  
only applicable to seed cake containing solvent extractions, iron oxide, spent and iron sponge, spent
- Class 4.3 Substances which in contact with water, emit flammable gases
- Class 5.1 Oxidizing substances only applicable to ammonium nitrate fertilizers  
Miscellaneous dangerous substances, which, proven by experience, be of such a dangerous
- Class 9 character that the provisions of this Section shall apply to them only applicable to ammonium nitrate fertilizers
- MHB Materials which, if carried in bulk, constitute a risk and require certain precautions

## D. Hazardous Areas and Permitted Electrical Equipment

Hazardous areas are areas in which the cargo carried, specified under C., can give rise to potentially explosive or explosive atmospheres.

Explosion-protection measures are required in these areas.

### 1. Hazardous areas comprise the following:

**1.1** Areas in which a dangerous gas/air mixture, dangerous vapours or a dangerous quantity and concentration of dust are liable to occur from time to time are defined to be areas subject to explosion hazard (zone 1).

**1.2** Areas in which a dangerous gas/air mixture, dangerous vapours or a dangerous quantity and concentration of dust are liable to occur only rarely, and then only for a brief period, are defined to be extended dangerous areas (zone 2).

**1.3** For the definition of hazardous areas, see [Section 1, B.12](#).

**2.** Electrical equipment shall be installed in hazardous areas only when it is unavoidable for operational reasons. The explosion protection of the installed and operated electrical equipment shall meet the characteristics of the dangerous cargo.

**3.** Electrical equipment is defined as a certified safe type if it is manufactured to a recognized standard, such as IEC Publication 60079 or equivalent, and has been tested and approved by an approval authority recognized by BKI.

**4.** Hazardous areas for which protective measures are required on principle, and the permitted electrical equipment, are described in the following paragraphs.

### **4.1 Carriage of explosive substances in packaged form, according to class 1 (see C.1.), except goods in division 1.4, compatibility group S**

#### **4.1.1** Hazardous areas (zone 1) (see [Fig. 17.1](#) and [Fig. 17.2](#))

- 1) Closed cargo spaces, and closed or open Ro-Ro cargo spaces
- 2) Stationary containers (e.g. magazines)

#### **4.1.2** Minimum requirements for electrical equipment

- 1) Explosive, dusty atmosphere:
  - degree of protection IP 65
  - maximum surface temperature 100 °C
- 2) Potentially explosive, gaseous atmosphere: Certified safe type equipment in

- explosion group IIA
  - temperature class T5
  - cables as described in E.
- 3) Explosive dusty and potentially explosive gaseous atmosphere: the requirements of 1) and 2) shall be fulfilled.
- 4) The following certified safe type equipment may be used for 2) and 3):
- Ex i, intrinsic safety
  - Ex d, flame-proof enclosure
  - Ex e, increased safety, only for luminaires
  - other certified safe type equipment may be used if safe operation in the atmosphere to be expected is guaranteed

#### 4.2 Carriage of solid goods in bulk which may develop dangerous dust only (see C.2.)

##### 4.2.1 Hazardous areas (zone 1) (see Fig. 17.1 and Fig. 17.2)

- 1) Closed cargo spaces
- 2) Ventilation ducts for hazardous areas
- 3) Enclosed or semi-enclosed spaces with non-closable (e.g. by doors or flaps) direct openings to 1) or 2)

##### 4.2.2 Minimum requirements for electrical equipment (see also Section 1, K.3.3)

- degree of protection IP 55
- maximum surface temperature 200 °C

or explosion-protected equipment

- degree of protection IP 55
- temperature class T3
- cables, as described in E.

4.2.3 Where the characteristics of the cargo demand a lower surface temperature, this shall be considered (see also D.5).

4.3 Carriage of flammable liquids with a flash point  $\leq 23$  °C in packaged form, flammable gases (see C.1.) and highly dangerous bulk cargoes which, under certain conditions, develop a potentially explosive gaseous atmosphere (see C.2)

##### 4.3.1 Hazardous areas (zone 1) (see Fig. 17.1 and Fig. 17.2)

- 1) Closed cargo spaces and closed or open Ro-Ro cargo spaces
- 2) Ventilation ducts for hazardous areas
- 3) Enclosed or semi-enclosed rooms with non-closable (e.g. by doors or flaps) direct openings to 1) or 2)
- 4) Areas on open deck or semi-enclosed spaces on open deck within 1,5 metres of any ventilation opening as described in 2)

**4.3.2** Minimum requirements for certified safe type equipment for areas specified in 4.3.1.1) to 4):

- explosion group II C
- temperature class T4
- cables, as described in E.

If no hydrogen, no hydrogen mixtures and no cargo in bulk which may develop hydrogen under certain conditions will be carried, the explosion group may be set to II B, see also D.5. and F.

**4.4 Extended hazardous areas and permitted equipment**

**4.4.1** Extended hazardous area (zone 2) (see Fig. 17.1 and 17.2)

- 1) Areas which can be separated by gas-tight doors from hazardous areas.

Weather-tight doors are considered to be adequately gas-tight.

These areas pass for safe if they

- have overpressure mechanical ventilation with at least 6 changes of air per hour. Should the ventilation fail, this shall be announced optically and audibly, and the facilities not permitted for the extended hazardous area shall be switched off (see also 4.4.3)

or

- are naturally ventilated and protected by airlocks.

- 2) When carrying flammable liquids having flashpoints less than 23°C as Class 3, 6.1 or 8 in cargo spaces, the bilge pipes with flanges, valves, pumps, etc. constitute a source of release and the enclosing spaces (e.g. pipe tunnels, bilge pump rooms, etc.) are to be classified as an extended hazardous area (comparable with Zone 2) unless these spaces are continuously mechanically ventilated with a capacity for at least six air changes per hour. Except where the space is protected with redundant mechanical ventilation capable of starting automatically, equipment not certified for Zone 2 are to be automatically disconnected following loss of ventilation while essential systems such as bilge and ballast systems are to be certified for Zone 2.

Where redundant mechanical ventilation is employed, equipment and essential systems not certified for Zone 2 shall be interlocked so as to prevent inadvertent operation if the ventilation is not operational. Audible and visible alarms shall be provided at a manned station if failure occurs.

- 3) Areas of 1,5 metres surrounding open or semi-enclosed spaces of zone 1 as described in 4.3.1.4)

**4.4.2** Minimum requirements for electrical equipment for the areas specified in 4.4.1 1) - 3)

- 1) Use of certified safe type equipment, as for hazardous areas or
- 2) Use of equipment with Ex n type protection or
- 3) Use of equipment which does not produce sparks in normal operation and whose surfaces do not attain inadmissible temperatures or
- 4) Equipment with simplified pressurized enclosure or a vapour-tight enclosure (minimum degree of protection IP 55), and whose surfaces do not attain inadmissible temperatures
- 5) Installation and cables, as described in E.

**4.4.3 Essential equipment**

In ventilated rooms, equipment important for the safety of the crew or the ship shall be so designed that it fulfils the requirements for unventilated spaces. It shall not be switched off.



## 5. Special assessments

5.1 If no details of the characteristics of the prospected cargo are available, or if a ship is intended to be used for the carriage of all the materials defined in C., the electrical equipment shall fulfil the following requirements:

- degree of protection IP 65
- maximum surface temperature 100 °C
- explosion group II C
- temperature class T5

5.2 On ships intended exclusively for the carriage of containers, where containers with dangerous goods (see 5.1) are stowed in the cargo hold (with the exception of class 1 goods, hydrogen and hydrogen mixtures), the electrical equipment shall fulfil the following requirements:

- degree of protection IP 55
- maximum surface temperature 135 °C
- explosion group II B
- temperature class T4

5.3 Deviations from the provisions stated in 5.1 or 5.2 are possible. They are noted in the certificate and restrict the carriage of dangerous goods in accordance with the characteristics of the materials and the equipment.

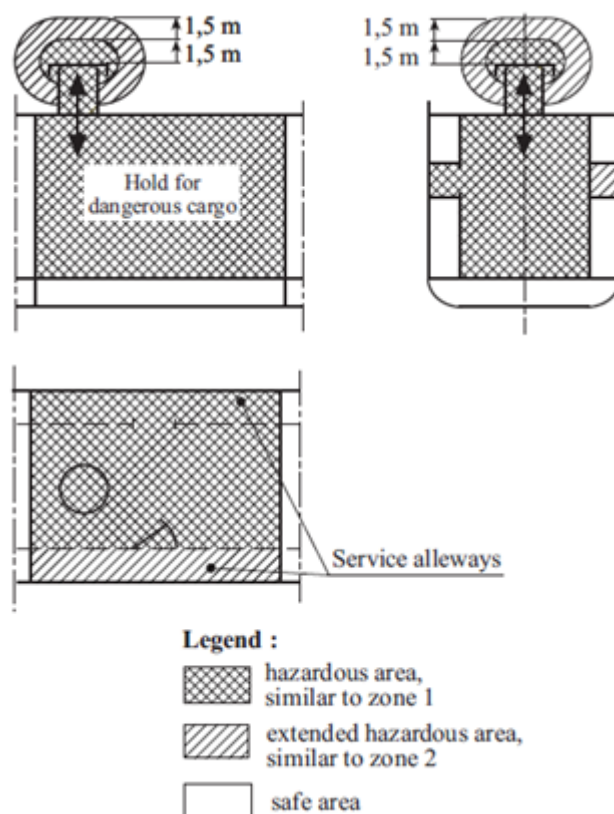

Figure 17.1: Examples for service alleyways, open to the hold and lockable with door

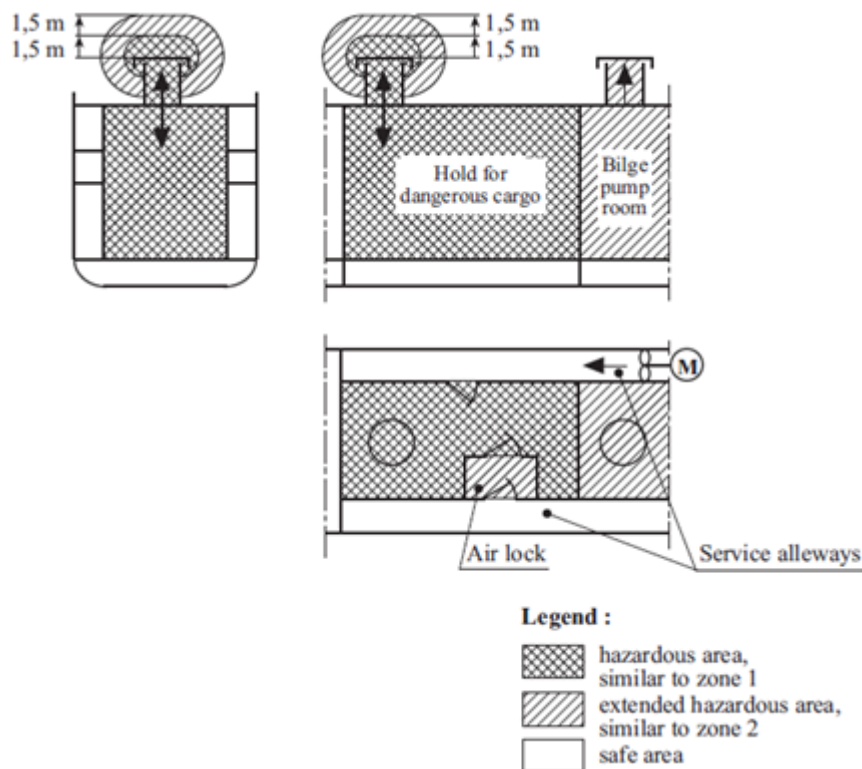

Figure 17.2: Examples for service alleyways, lockable with door and air-lock to the hold

## E. Installation of Electrical Systems in Hazardous Areas

### 1. Installation of electrical equipment in hazardous area (zone 1)

1.1 If electrical equipment is installed which is not suitable for use in areas with an explosion hazard, it shall be capable of being switched-off and safe-guarded against unauthorized re-switching. The switching devices shall be located outside the hazardous area, and shall, wherever possible, consist of isolating links or lockable switches.

Where electrical equipment is important for the safety of the crew or the ship, it shall not be switched-off and shall be approved for use in hazardous areas.

1.2 Cables shall be armoured or shall have a braided screen, unless they are laid in metallic conduits.

1.3 Bulkhead and deck penetrations shall be sealed to prevent the passage of gases or vapours.

1.4 Portable electrical equipment, important for aboard operation and used in hazardous areas or stipulated for such use by regulations shall be of a certified safe type.

### 2. Installation of electrical equipment in extended hazardous areas (zone 2)

2.1 If electrical equipment is installed which is not suitable for the use in extended dangerous areas, it shall be capable of being switched-off and safe-guarded against unauthorized re-switching. Switching-off shall be made outside of the hazardous area, unless the switching devices are approved for this area.

Where electrical equipment is important for the safety of the crew or the ship, it shall not be switched-off and shall be approved for the use in extended hazardous areas.

2.2 Cables shall be protected installed.

## F. Certification if Installations Not Conform to the above Provisions

In the event of non-conformity with the above provisions, the lowest relevant explosion group and temperature class are entered in the certificate for the carriage of dangerous goods.

### G. Fire Pumps

If the fire main pressure drops, the fire pumps shall start automatically or shall be switched on by a remotestarting device installed on the bridge, see also [Rules for Machinery Installations \(Pt.1, Vol.III\)](#), Sec. 12.

### H. Alternative Electrical Power Supply for Ships Intended for the Carriage of Packaged Irradiated Nuclear Fuel, Plutonium and High-level Radioactive Wastes

Regarding the alternative electrical power supply, the IMO Resolution MSC.88 (71) (INF-Code) shall be observed.

**Table 17.1: Characteristics of Electrical Equipment for Use in Hazardous Areas (Zone 1) for the Carriage of Solid Dangerous Goods in Bulk and Materials Hazardous only in Bulk (MHB)**

Bulk Cargo Shipping Name (BCSN)	Class	Hazard	Protection against explosive		
			atmosphere		dust
			Explosion group	Temperature Class	Degree of protection
ALUMINUM FERROSILICON POWDER UN 1395	4.3	H <sub>2</sub>	IIC	T2	-
ALUMINUMSILICON POWDER, UNCOATED UN 1398	4.3	H <sub>2</sub>	IIC	T2	-
ALUMINUM SMELTING BY PRODUCTS or ALUMINIUM REMELTING BY PRODUCTS UN 3170	4.3	H <sub>2</sub>	IIC	T2	-
AMMONIUM NITRATE UN 1942	5.1	Combustible	-	T3	-
AMMONIUM NITRATE BASED FERTILIZER UN 2067	5.1	Combustible	-	T3	-
AMMONIUM NITRATE BASED FERTILIZER UN 2071	9	Combustible	-	T3	-
BROWN COAL BRIQUETTES	MHB	Dust, methane	IIA	T4	IP55
COAL	MHB	Dust, methane	IIA	T4	IP55
DIRECT REDUCED IRON (A) Briquettes, hot-moulded	MHB	H <sub>2</sub>	IIC	T2	-
DIRECT REDUCED IRON (B) Lumps, pellets, cold-moulded briquettes	MHB	H <sub>2</sub>	IIC	T2	-
DIRECT REDUCED IRON (C) (By- product fines)	MHB	H <sub>2</sub>	IIC	T2	-
Dust (e.g. from grain)	-	Dust	-	-	IP55
FERROPHOSPHORUS	MHB	H <sub>2</sub>	IIC	T1	-
FERROSILICON	MHB	H <sub>2</sub>	IIC	T1	-
FERROSILICON UN 1408	4.3	H <sub>2</sub>	IIC	T1	-
IRON OXIDE, SPENT or IRON SPONGE, SPENT UN 1376	4.2	Dust	IIA	T2	IP55
SEED CAKE, containing vegetable oil UN 1386 (b) solvent extracted seeds	4.2	Hexane	IIA	T3	-
SEED CAKE UN 2217	4.2	Hexane	IIA	T3	-
SILICOMANGANESE	MHB	H <sub>2</sub>	IIC	T1	-
SULPHUR UN 1350	4.1	Combustible	-	T4	-
ZINC ASHES UN 1435	4.3	H <sub>2</sub>	IIC	T1	-
<b>Note</b>					
The term "Hazard" relates exclusively to the danger of explosion attributable to the dangerous goods and the electrical appliances.					

*This page intentionally left blank*

## Section 18 Additional Rules for Bulk Carriers and Single Hold Cargo Ships other than Bulk Carriers

A.	General . . . . .	18-1
B.	Water Level Detectors . . . . .	18-1

### A. General

#### 1. Scope

These requirements apply additionally to electrical plants on

- bulk carriers, or
- single hold cargo ships other than bulk carriers constructed before 1 January 2007 shall comply with the requirements not later than 31 December 2009, or
- cargo ships having a length (L) of less than 80 metres, or 100 metres if constructed before 1 July 1998, and a single cargo hold below the freeboard deck or cargo holds below the freeboard deck which are not separated by at least one bulkhead made watertight up to that deck, except for ships complying with Regulation XII/12, or in ships having watertight side compartments each side of the cargo hold length extending vertically at least from inner bottom to freeboard deck.

#### 2. References to other Rules

[Rules for Hull \(Pt.1, Vol.II\) Sec. 23.](#)

### B. Water Level Detectors

#### 1. General

##### 1.1 Definition

Water level detectors means a system comprising sensors and indication devices that detect and warn of water ingress in cargo holds and other spaces as required for bulk carriers in SOLAS Regulation XII/12.1 and for single hold cargo ships other than bulk carriers as required in SOLAS "Amendments 2009 Regulation 25-3.

##### 1.2 Means of detecting water ingress

**1.2.1** The method of detecting water ingress may be by direct or indirect means.

A direct means of detection determines the presence of water by physical contact of the water with the detection device.

Indirect means of detection include devices without physical contact with the water.

**1.2.2** The location shall be either as close to the centre line as practicable, or located at both the port and starboard sides, if practicable.

For bulk carrier, the detectors are also to be located in the aft part of each cargo hold or in the lowest part of the spaces other than cargo holds to which these Rules apply.

For single hold cargo ships other than bulk carrier the detectors are also to be located in the aft part of the hold or above its lowest point in such ships having an inner bottom not parallel to the designed waterline. Where webs or partial watertight bulkheads are fitted above the inner bottom, Administrations may require the fitting of additional detectors.

**1.2.3** The systems of detecting water level shall be capable of continuous operation while the ship is at sea.

**1.2.4** Cargo holds shall be monitored for a pre-alarm and a main-alarm water level. Compartments other than cargo holds shall be monitored for the presence of water.

Pre-alarm level means the lower level at which the sensor(s) in the cargo hold space will operate. The pre-alarm is to indicate a condition that requires prompt attention to prevent an emergency condition.

Main alarm level means the higher level at which the sensor(s) in the cargo hold space will operate or the sole level in spaces other than cargo holds. The main alarm is to indicate that immediate action is to be taken to prevent danger to human life or to the ship.

#### **1.2.5 Documents for submission**

Documents for submission shall contain the following information and operational instructions:

- Line diagrams of the detection and alarm system showing the positions of equipment
- list of cargoes for which the performance of the detector has been demonstrated and certified, with information and/or evidence of certification for the certified safe type electrical equipment, if fitted
- maintenance requirements for equipment and system
- installation instructions for orientation, setting, securing, protecting and testing
- procedures to be followed in the event equipment not functioning correctly
- a description of the equipment for detection and alarm arrangements together with a listing of procedures for checking that as far as practicable, each item of equipment is working properly during any stage of ship operation
- a test procedure for the tests on board according to [5.2](#)
- type test Certificate(s) for the system

Manuals shall be provided on board.

## **2. Installations**

**2.1** Detectors, electrical cables and any associated equipment installed in cargo holds are to be protected from damage by cargoes or mechanical handling equipment.

**2.2** Any changes/modifications to the ship's structure, electrical systems or piping systems are to be approved by BKI before work is carried out

**2.3** Detectors and equipment are to be installed where they are accessible for survey, maintenance and repair.

### 3. Detector system requirements

#### 3.1 General

**3.1.1** Detector systems are to provide a reliable indication of water reaching a preset level and are to be type tested.

**3.1.2** The detector arrangement in cargo holds shall be capable to detect the water level in two steps, at a pre-and a main-alarm level. In compartments other than cargo holds one detection level is sufficient.

**3.1.3** Detectors shall be capable to operate in cargo/water mixture for the selected range of cargoes such as iron ore dust, coal dust, grains and sand using sea water with a suspension of representative fine material for each cargo.

**3.1.4** The detector shall activate the corresponding alarm within  $\pm 100$  mm of the pre-set level. Water density is to be taken as between 1000 and 1025 kg/m<sup>3</sup>.

**3.1.5** The installation of detectors shall not inhibit the use of any sounding pipe or other water level gauging device for cargo holds or other spaces

**3.1.6** Detectors are to be capable of being functionally tested in fitted condition when the hold is empty using either direct or indirect means.

**3.1.7** Detectors have to be of the fail-safe type such that wire break and short circuit is to be indicated by an alarm. See also [4.1.4](#).

**3.1.8** The maximum surface temperature of equipment installed within cargo spaces is to be appropriate for the combustible dusts and/or explosive gasses likely to be encountered. Where the characteristics of the dust and gases are unknown, the maximum surface temperature of equipment is not to exceed 85°C (T<sub>6</sub>).

#### 3.2 Requirements depending on location

**3.2.1** Protection of the enclosures of electrical components installed in the cargo holds, ballast tanks and dry spaces is to satisfy the requirements of IP 68 in accordance with IEC publication 60529.

**3.2.2** Protection of the enclosures of electrical equipment installed above ballast and cargo spaces is to satisfy the requirements of IP 56 in accordance with IEC publication 60529.

**3.2.3** Detection equipment is to be corrosion resistant for all environments that may be experienced in cargo holds and dry/ballast spaces. The manufacturer is to declare a list of environments for which the detection equipment is suitable for use.

**3.2.4** Detectors and electrical cables to be installed in holds intended for use with cargoes that require protection against ignition caused by electrical installations are to be of a certified safe type (Ex ia).

**3.2.5** Detectors are to be suitable for the cargo intended to be transported, including exposure to dust environments associated with bulk cargoes.

### 4. Alarm system requirements

#### 4.1 General

Visual and audible alarms are to be in accordance with IMO-Resolution A.1021 (26) "Code on Alerts and Indicators, 2009" as applicable to a Primary Alarm for the preservation or safety of the vessel.

Requirements stated in [Rules for Automations \(Pt.1, Vol.VII\)](#), for alarm and monitoring systems shall be observed.

**4.1.1** The alarms shall be located on the navigation bridge. The signalisation shall be suitable for this environment and shall not seriously interfere with other activities necessary for the safe operation of the ship.

**4.1.2** Alarm systems are to be type tested.

**4.1.3** A switch for testing audible and visual alarms is to be provided at the alarm panel and the switch shall return to the off position when not operated.

**4.1.4** The complete system including the detectors is to be of the self-monitoring type and any failure of the detectors or in the connecting cables is to be recognised by the system and alarmed.

**4.1.5** The detection of a pre-set level of water in any space shall activate an alarm indicating the space affected and the pre-set level of water that has been detected.

**4.1.6** The audible alarm signalisation shall distinguish between pre- and main-alarm level.

**4.1.7** Time delays may be incorporated into the alarm system to prevent spurious alarms due to sloshing effects associated with ship motions.

**4.1.8** For cargo holds the system shall be capable of the following:

**.1** An alarm, both visual and audible, activated when the depth of water at the sensor reaches the pre-alarm level in the space being monitored. The indication shall identify the space.

For bulk carrier, the pre-alarm level is 0,5 metre above the inner bottom.

For single hold cargo ships other than bulk carriers the pre-alarm level is not less than 0,3 metre above the inner bottom.

**.2** An alarm, both visual and audible, activated when the level of water at the sensor reaches the main alarm level, indicating increasing water level in a cargo hold. The indication shall identify the space and the audible alarm shall not be the same as that for the pre-alarm level.

For bulk carrier, the alarm level is at a height not less than 15 % of the depth of the cargo hold but not more than 2 metres.

For single hold cargo ships other than bulk carriers the water level detectors shall give an audible and visual alarm at the navigation bridge when the water level above the inner bottom in the cargo hold reaches a height of not less than 0,3 metre, and another when such level reaches not more than 15 % of the mean depth of the cargo hold.

**4.1.9** For compartments other than cargo holds the system shall be capable of the following:

**.1** An alarm, both visual and audible, indicating the presence of water in a compartment other than a cargo hold when the level of water in the space being monitored reaches the sensor. The visual and audible characteristics of the alarm indication shall be the same as those for the main alarm level in a hold space.

For bulk carrier the water level detectors in any ballast tank forward of the collision bulkhead required by SOLAS Regulation II-1/11, giving an audible and visual alarm when the liquid in the tank reaches a level not exceeding 10 % of the tank capacity. An alarm overriding device may be installed to be activated when the tank is in use. Also, for bulk carrier the water level detectors in any dry or void space other than a chain cable locker, any part of which extends forward of the foremost cargo hold, giving an audible and visual alarm at a water level of 0,1 metre above the deck. Such alarms need not be provided in enclosed spaces the volume of which does not exceed 0,1 % of the ship's maximum displacement volume.

## **4.2 Override**

**4.2.1** The system may be provided with a capability of overriding indication and alarms for the detection system installed only in tanks and holds that have been designed for carriage of water ballast.

**4.2.2** Where such an override capability is provided, cancellation of the override condition and reactivation of the alarm shall automatically occur after the hold or tank has been deballasted to a level below the lowest alarm indicator level.



### 4.3 Power supply

**4.3.1** The alarm system is to be supplied from two separate sources. One is to be the main source of electrical power and the other is to be the emergency source of electrical power.

**4.3.2** Failure of the primary electrical power supply is to be indicated by an alarm.

**4.3.3** The secondary power supply may be a continuously charged dedicated accumulator battery, having arrangement, location and endurance equivalent to that of the emergency source, see [Section 20.D](#). The battery may be an internal battery in the water level detector system.

**4.3.4** Where an accumulator battery is used for the secondary power supply, failure of both power supplies is to be indicated by dedicated alarms.

## 5. Tests

### 5.1 Type test

**5.1.1** The Detectors and the Alarm System is subject to mandatory type testing. Basis are the [Guidance for The Approval and Type Approval of Materials and Equipment for Marine Use \(Pt.1, Vol.W\) Sec.3.V](#).

**5.1.2** For type test purposes an agitated suspension of representative fine materials in seawater, with a concentration of 50 % by weight, is to be used with the complete detector installation including any filtration devices fitted.

The functioning of the detection system with any filtration arrangements is to be verified in the cargo/water mixture repeated ten times without cleaning.

**5.1.3** The water pressure testing of the enclosure is to be based on a pressure head held for a period depending on the application:

For detectors to be fitted in holds intended for the carriage of water ballast or ballast tanks the application head is to be the hold or tank depth and the hold period is to be 20 days.

For detectors to be fitted in spaces intended to be dry the application head is to be the depth of the space and the hold period is to be 24 hours.

**5.1.4** The equipment manufacturer is to demonstrate the effectiveness and cleaning of any filters/strainers that are fitted to the detector units.

### 5.2 Tests on board

After installation, a functionality test for each water ingress detection system is to be carried out.

**5.2.1** The test shall represent the presence of water at the detectors for every level monitored. Simulation methods may be used where the direct use of water is impracticable.

**5.2.2** Each detector alarm shall be tested to verify that the pre-alarm and main alarm levels operate for every space where they are installed and indicate correctly.

**5.2.3** The fault monitoring arrangements shall be tested as far as practicable.

**5.2.4** Records of testing of the system shall be retained on board.

*This page intentionally left blank*

## Section 19 Additional Rules for Ships with Ice Class

A. Ships with Ice Class . . . . . 19-1

### A. Ships with Ice Class

#### 1. Electrical installations

**1.1** The selection, layout and arrangement of all shipboard machinery, equipment and appliances shall be such as to ensure faultless continuous operation in arctic ice-covered waters. The provision may not be affected of emergency heat and power by interference in the electrical system.

**1.2** Precautions shall be taken to minimize risk of supplies to essential and emergency services being interrupted by the inadvertent or accidental opening of switches or circuit breakers due to vibrations or accelerations during icebreaking operations.

**1.3** Emergency power supply for communications equipment provided by battery shall be provided with a means whereby the batteries are protected from extreme low temperatures.

**1.4** Emergency power batteries, including those stored in deck boxes shall be secured in a position where excessive movement is prevented during ice-transiting operations and explosive gas ventilation is not restricted by the accumulation of ice or snow.

**1.5** Control systems based on computers and other electronic hardware installations necessary for the proper functioning of essential equipment should be designed for redundancy and resistance to vibration, dampness and low humidity.

*This page intentionally left blank*

## Section 20 Electrical Equipment

A.	Electrical Machinery . . . . .	20-1
B.	Transformers and Reactance Coils . . . . .	20-5
C.	Capacitors . . . . .	20-7
D.	Storage Batteries, Chargers and Uninterruptible Power Supplies (UPS) . . . . .	20-7
E.	Switchgear and Protection Devices . . . . .	20-10
F.	Cables and Insulated Wires . . . . .	20-12
G.	Cable Penetrations and Fire Stops . . . . .	20-14
H.	Installation Material . . . . .	20-14
I.	Lighting Fixtures . . . . .	20-14
J.	Electrical Heating Equipment . . . . .	20-15

### A. Electrical Machinery

#### 1. Generators and motors

Electrical machines shall conform to IEC publication 60034 or an equivalent standard.

For medium-voltage machines, see also [Section 8](#).

##### 1.1 Materials

Materials for the construction of electrical machines shall conform to the requirements set out in [Section 1, J](#).

For shaft materials, see [1.4](#).

##### 1.2 Degree of protection

Protection against electric shock, accidental contacts and the entry of foreign bodies and water shall conform to [Section 1, K](#). The degree of required protection shall be assured when the equipment is installed and in operation.

##### 1.3 Ventilation and cooling

**1.3.1** The construction of machines with coolants other than air shall be agreed with BKI considering the operating conditions.

##### 1.3.2 Heat exchanger/cooler

Cooling units shall comply with the [Rules for Machinery Installations \(Pt.1, Vol. III\) Sec.8](#). Cooling units with the operating medium water, a design pressure  $p_c \leq 16$  bar and a design temperature  $t \leq 200$  °C correspond to pressure vessel class III.

##### 1.3.3 Draught ventilation

The supply air to draught-ventilated machines shall be as far as practicable free of moisture, oil vapours and dust. If required filters shall be provided.

### 1.3.4 Enclosed air cooling circuit

Where heat-exchangers are used in the air circuit, they shall be designed and mounted in such a way that condensation or leakage water from the exchanger system is kept away from the machine windings.

Leakage monitoring is required. The water supply-lines and recirculating lines of each heat-exchanger shall be fitted with shut-off valves. The air ducts shall be provided with inspection holes for visual observation of the heat-exchanger.

A failure of cooling (air filters, fan flaps, forced ventilation, re-cooling) shall be alarmed, e.g. by monitoring of the cooling air temperature.

Machines for electric propulsion plants shall be equipped with monitoring devices in accordance with [Section 13, H](#).

Machines fitted with brushes shall be ventilated in such direction that fines from the brushes does not enter the inside of the machine.

### 1.3.5 Surface cooling

Surface-cooled machines on the open deck shall have external fans only if they are fully protected against icing.

## 1.4 Construction of shafts

The materials for the shafts of

- motors of electric propulsion plants
- main generators supplying the motors of electric propulsion plants
- shaft generators or supplementary electrical drives if their shafts form part of the ship's main shafting

shall conform to the [Guidance for the Approval and Type Approval of Materials and Equipment for Marine Use \(Pt.1, Vol.W\) Sec.2.D](#), and [Rules for Machinery Installations \(Pt.1, Vol. III\) Sec.4](#).

Shaft material for electric propulsion motors and for main engine driven generators where the shaft is part of the propulsion shafting is to be certified by BKI.

Shaft material for other machines is to be in accordance with recognised international or national standard.

Proof shall take the form of a BKI acceptance test Certificate, similar as for propeller shafts.

Welds on shafts and rotors shall comply with [Rules for Materials \(Pt.1, Vol. V\)](#) and [Rules for Welding \(Pt.1, Vol. VI\)](#).

## 1.5 Bearings and bearing lubrication

### 1.5.1 Plain bearings

Bearing shells shall be easily replaceable. Provision shall be made for checking the bearing lubrication. Adequate lubrication shall be assured even in inclined positions in accordance with [Section 1, Table 1.2](#). No oil shall flow out and penetrate into the machine.

In the case of bearings with forced lubrication, failure of the oil supply and the attainment of excessive bearing temperatures shall cause an alarm.

Two-part bearings shall be fitted with thermometers indicating, wherever possible, the temperature of the lower bearing shell.

Turbogenerators and propulsion motors shall be equipped with devices which, in the event of a failure of the normal lubricating oil supply, provide adequate lubrication until the machine has come to standstill.

### 1.5.2 Prevention of bearing currents

To avoid damage to bearings, it is essential to ensure that no harmful currents can flow between bearing and shaft.

### 1.6 Standstill heating system

Generators and main propulsion motors with an output  $\geq 500$  kW and all transverse-thruster motors shall be equipped with an electric heating designed to maintain the temperature inside the machine at about 3 K above ambient temperature.

An indicator shall show when the standstill heating system is in operation.

### 1.7 Accessibility for inspection, repairs and maintenance

Components like commutators, sliprings, carbon brushes and regulators for example shall be accessible for inspection, repairs and maintenance.

For larger machines with plain bearings, provision shall be made for the direct or indirect measurement of the air gap.

### 1.8 Windings

In interaction with the specified protection devices, machines shall be able to withstand the dynamic and thermal stresses likely to result from a short circuit.

Machines shall be designed and rated in such a way that the permissible temperature rises listed in [Guidance for The Approval and Type Approval of Materials and Equipment for Marine Use \(Pt.1, Vol.W\) Section.3.T Table 3.30](#) are not exceeded.

All windings shall be effectively protected against the effects of oil vapours and air laden with moisture or salt.

### 1.9 Air gaps

Machines with only one internal bearing shall have a minimum air gap of 1,5 mm.

Where generators are intended for incorporation in the line shafting, the design of the generator and its foundations shall ensure faultless operation of the propulsion plant even in heavy seas, and regardless of the loading condition of the ship. In consideration of the special service conditions, the generator air gap shall not be less than 6 mm.

### 1.10 Brush rocker

The operation position of the brush rocker shall be clearly marked.

### 1.11 Terminal boxes

Terminal boxes shall be located in accessible positions.

Separate terminal boxes are required for terminals with service voltages above 1000 V AC or 1500 V DC.

Terminals shall be clearly marked.

The degree of protection of terminal boxes shall correspond to that of the machine but shall in no case be less than IP 44 (see [Section 1.K](#)).

### 1.12 Voltage regulators

Regulators shall withstand the loads expected at the place of installation (see [Section 1](#)).

The installation of regulators in terminal boxes is only permitted if the regulator units are mechanically separated so that they cannot be damaged during the mounting of the main cables.

Set point adjusters shall be so designed that shifting of themselves is impossible, and they shall be adjustable from outside by use of a tool only.

### 1.13 Operation in network with semiconductor converters

Electric machines operating in networks containing semiconductor converters shall be designed for the expected harmonics of the system. A sufficient reserve shall be considered for the temperature rise, compared with a sinoidal load.

### 1.14 Rating plate

Machines shall be fitted with durable corrosion- resistant rating plates.

## 2. Magnetic brakes

The requirements stated in [1](#). shall be applied correspondingly.

The temperature rise of the windings shall not exceed the permitted values shown in [Guidance for The Approval and Type Approval of Materials and Equipment for Marine Use \(Pt.1, Vol.W\) Section.3.T Table 3.30](#).

Where windings are located in the immediate vicinity of the brake linings, the heat generated during braking shall be considered.

## 3. Magnetic clutches

The requirements stated in [1](#). shall be applied correspondingly.

When engaged, the clutch shall take over the drive smoothly and reliably. The clutch shall exert no axial thrust.

## 4. Testing of electrical machinery

All electric machines shall be tested at the manufacturer's works.

Manufacturer's test records are to be provided for machines for essential services, for other machines they are to be available upon request.

The tests shall be performed in accordance with IEC 60034-1:2017 and 60092-301:1980/AMD2:1995. BKI reserve the right to stipulate additional tests in the case of new types of machines or where it is required for another particular reason

### 4.1 Tests in the presence of the surveyor

The machines listed below are subject to testing in the manufacturer's works in the presence of the Surveyor during test and, if appropriate, during manufacturing.

- 1) Generators and motors for essential equipment with outputs of 100 kW and over, intended for essential services;
- 2) Motors for installations with a Class Notation such as e.g. **SMP** with an output of 100 kW or more;
- 3) Material test for shafts of:



- motors of electric propulsion plants
- main generators supplying the motors of electric propulsion plants and
- shaft generators or supplementary electrical drives if their shafts form part of the ship's main shafting (see 1.4 and Section 13.K)

**Note:**

*An alternative survey scheme may be agreed by the BKI with the manufacturer whereby attendance of the Surveyor will not be required as required above. See [Guidance for Approval and Type Approval of Materials and Equipment for Marine Use \(Pt.1, Vol.W\) Sec.5.](#)*

#### 4.2 Works test reports

On request, works test reports shall be presented for machines not tested in the presence of the Surveyor.

#### 4.3 Extent of tests

Type tests are to be carried out on a prototype machine or on the first of a batch of machines, and routine tests carried out on subsequent machines in accordance with [Table 20.1](#).

Detail of the test are in accordance with requirements in [Guidance for Approval and Type Approval of Materials and Equipment for Marine Use \(Pt.1, Vol.W\) Sec.3.T](#).

**Note:**

*Test requirements may differ for shaft generators, special purpose machines and machines of novel construction.*

## B. Transformers and Reactance Coils

### 1. General

Transformers and Reactance Coils shall conform to IEC publication 60076, Power transformers or an equivalent standard.

For medium-voltage machines, see also [Section 8](#).

#### 1.1 Coolant

Preferably dry type transformers shall be used on board of ships.

For separately cooled transformers the cooling air shall be monitored

#### 1.2 Windings

All transformers shall have separate windings for primary and secondary coils, except for starting and ignition transformers, which may be of the autotransformer type.

**Table 20.1: Summary of tests to be carried out**

No.	Tests	AC generators		Motors	
		Type test 1	Routine test 2	Type test 1	Routine test 2
1	Technical documentation check and visual inspection	x	x	x	x
2	Winding resistance measurement	x	x	x	x
3	No load test	x	x	x	x
4	Load test and heat run test	x		x	
5	Overload, overcurrent test	x	x <sup>4</sup>	x	x <sup>4</sup>
6	Short-circuit test 5	x			
7	Overspeed test	x	x	x <sup>6</sup>	x <sup>6</sup>
8	Winding test (High voltage test)	x	x	x	x
9	Insulation resistance measurement	x	x	x	x
10	Degree of protection check	x		x	
11	Bearing check	x	x	x	x
12	Test of voltage regulator, see <a href="#">Section 3.B.2</a> <sup>3</sup>	x	x		

<sup>1</sup> test of the first machine of a series  
<sup>2</sup> test of all other machines of the series  
<sup>3</sup> test together with 5.  
<sup>4</sup> only applicable for machine of essential services rated above 100 kW  
<sup>5</sup> applies to synchronous generator only  
<sup>6</sup> not applicable for squirrel cage motors

## 2. Rating

### 2.1 Voltage variation during loading

Under resistive load, the voltage variation between no-load and full-load shall not exceed 5 %.

This requirement does not apply to short-circuit-proof transformers

### 2.2 Temperature rise

The temperature rise of windings shall not exceed the values listed in [Guidance for The Approval and Type Approval of Materials and Equipment for Marine Use \(Pt.1, Vol.W\) Section.3.T Table 3.27](#).

Parts of casings with surface temperatures over 800°C shall be protected against unintentionally contact.

### 2.3 Short-circuit resistance

Transformers, in co-operation with their protection devices, shall be able to withstand without damage the effects of external short-circuits.

## 3. Rating plate

Transformers shall be provided with a durable corrosion-resistant rating plate.

## 4. Tests

Transformers shall be tested in the manufacturer's works. Transformers rated with 100 kVA and above shall be tested in the presence of the Surveyor. A works test report covering the tests carried out shall be prepared.

The works test reports shall be presented on request. Scope of the tests are in accordance with the Requirements in [Guidance for Approval and Type Approval of Materials and Equipment for Marine Use \(Pt.1, Vol.W\) Sec. 3.T.](#)

## C. Capacitors

### 1. General

The requirements of this Section apply to power capacitors with a reactive power of 0,5 kVA and above.

### 2. Construction

#### 2.1 Capacitors shall have gastight steel casings.

The metal casings shall have means for the connection of earthing conductors.

The dimensional design of capacitors shall be such that, if a casing is damaged, not more than 10 litres of impregnating agent can leak out.

#### 2.2 Internal faults shall be limited by element fuses.

#### 2.3 Discharge resistors shall ensure the discharge of the capacitor down to a terminal voltage below 50 V within 1 minute after disconnection.

### 3. Testing

A type-test report shall be submitted for capacitors on request

### 4. Selection and operation

#### 4.1 The dissipation of heat by convection and radiation shall be ensured. In locations with a high ambient temperature, capacitors of a higher temperature class shall be used.

#### 4.2 The capacitor voltage rating shall be selected in accordance with the operating voltage of the power system, with due regard to a possible voltage increase caused by the capacitor and any inductances in series.

#### 4.3 In systems with high levels of harmonics, capacitors shall be protected against overloading by the use of series inductors and/or the selection of a higher capacitor voltage rating.

#### 4.4 To avoid self-excitation of individually compensated motors, the compensation power shall not exceed 90 % of the no-load reactive power of the motor.

#### 4.5 Reactive power controllers or electrical interlocks are required to avoid overcompensation of the ship's mains.

## D. Storage Batteries, Chargers and Uninterruptible Power Supplies (UPS)

### 1. General

#### 1.1 These Rules apply to stationary storage batteries and chargers.

#### 1.2 Rating of batteries

Storage batteries shall be so rated that they can supply the consumers for the required period, in accordance with the energy balance, when charged to 80 % of their rated capacity.

At the end of the supply period, the voltage at the battery or at the consumers shall conform as a minimum requirement to the values indicated in [Section 1, F.](#) and [3, C.](#)

#### 1.3 References to other rules

See [Section 2, C.](#) and [Section 3.C](#)

## 2. Storage batteries

- 2.1 Permitted are lead-acid storage batteries with diluted sulphuric acid as electrolyte and steel batteries with nickel-cadmium cells and diluted potassium hydroxide as electrolyte.
- 2.2 Other types of storage batteries such as silver/zinc batteries or sealed lead-acid batteries may be permitted, if their suitability for shipboard use is proven.
- 2.3 Storage batteries shall be so designed that they retain their rated capacity at inclinations of up to 22,5°, and no electrolyte leaks out at inclinations of up to 400. Cells without covers are not allowed.
- 2.4 The casing shall be resistant to electrolytes, mineral oils, cleaning agents and to corrosion by saline mist. Glass and readily flammable materials shall not be used for battery casings.
- 2.5 For storage batteries containing liquid electrolyte it shall be possible to check the electrolyte level. The maximum permissible electrolyte level shall be marked.
- 2.6 The weight of the greatest transportable unit shall not exceed 100 kg.
- 2.7 The nominal operating data of storage batteries shall be indicated on rating plates.
- 2.8 Storage batteries shall be maintained and operated in accordance with the manufacturer's instructions.

## 3. Chargers

- 3.1 Charger equipment shall be suitable for the type of storage batteries, the required charging characteristic and the selected connection.
- 3.2 Charging equipment shall be so rated that discharged storage batteries can be charged to 80 % of their rated capacity within a period not greater than 10 hours without exceeding the maximum permissible charging currents.
- Only automatic chargers shall be used with charging characteristics adapted to the type of batteries.
- 3.3 If consumers are simultaneously supplied during charging, the maximum charging voltage shall not exceed the rated voltage described in [Section 1, Table 1.7](#).
- The power demand of the consumers shall be considered for the selection of the chargers.
- 3.4 Chargers with a charging power above 2 kW shall be tested in presence of the Surveyor.
- 3.5 Refer to [Section 21.C.2.2 c\)](#) regarding tests in the manufacturer's works of battery chargers.

## 4. Uninterruptible power supplies (UPS)

### 4.1 General

4.1.1 These requirements to UPS units, as defined in IEC 62040-3:2011, apply when providing an alternative power supply or transitional power supply to services as defined in [Section 3.C](#). A UPS unit complying with these requirements may provide an alternative power supply as an accumulator battery in terms of being an independent power supply for services defined in [Section 3.C.3.2.4](#) or [Section 14. C.1.2.3](#).

### 4.1.2 Definitions

#### .1 Uninterruptible Power System (UPS)

Combination of converter, inverter, switches and energy storage means, for example batteries, constituting a power supply system for maintaining continuity of load power in case of input power failure (IEC 62040-3:2011).

#### .2 Off-line UPS unit

A UPS unit where under normal operation the output load is powered from the input power supply (via bypass) and only transferred to the inverter if the input power supply fails or goes outside preset limits. This transition will invariably result in a brief (typically 2 to 10 ms) break in the load supply.

### .3 Line interactive UPS unit

An off-line UPS unit where the bypass line switch to stored energy power when the input power goes outside the preset voltage and frequency limits.

### .4 On-line UPS unit

A UPS unit where under normal operation the output load is powered from the inverter and will therefore continue to operate without break in the event of the power supply input failing or going outside preset limits.

## 4.2 Design and construction

**4.2.1** UPS units are to be constructed in accordance with IEC 62040-1:2017, IEC 62040-2:2016, IEC 62040-3:2011, IEC 62040-4:2013 and/or IEC 62040-5-3:2016 as applicable or an acceptable and relevant National or International Standard. Battery ventilation shall be designed in accordance with [Section 2.C](#).

**4.2.2** The operation of the UPS is not to depend upon external services.

**4.2.3** The type of UPS unit employed, whether off-line, line-interactive or on-line, is to be appropriate to the power supply requirements of the connected load equipment.

**4.2.4** An external bypass is to be provided.

**4.2.5** The UPS unit is to be monitored. An audible and visual alarm is to be given on the ship's alarm system for:

- power supply failure (voltage and frequency) to the connected load,
- earth fault, if applicable,
- operation of battery protective device,
- when the battery is being discharged, and
- when the bypass is in operation for on-line UPS units.

## 4.3 Location

**4.3.1** The UPS unit is to be suitably located for use in an emergency.

**4.3.2** UPS units utilising valve regulated sealed batteries may be located in compartments with normal electrical equipment, provided the ventilation arrangements are in accordance with the requirements of IEC 62040-1:2017, IEC 62040-2:2016, IEC 62040-3:2011, IEC 62040-4:2013 and/or IEC 62040-5-3:2016 or an acceptable and relevant national or international standard.

## 4.4 Performance

**4.4.1** The output power is to be maintained for the duration required for the connected equipment as stated in [Section 3.C](#).

**4.4.2** No additional circuits are to be connected to the UPS unit without verification that the UPS unit has adequate capacity. The UPS battery capacity is, at all times, to be capable of supplying the designated loads for the time specified in [Section 3.C](#).

**4.4.3** On restoration of the input power supply, the rating of the charge unit shall be sufficient to recharge the batteries while maintaining the output supply to the load equipment.

## 4.5 Testing and survey

**4.5.1** UPS units of 50 kVA and over are to be surveyed by the BKI during manufacturing and testing.

**4.5.2** Appropriate testing is to be carried out to demonstrate that the UPS unit is suitable for its intended environment. This is expected to include as a minimum the following tests:

- Functionality, including operation of alarms;
- Temperature rise;
- Ventilation rate;
- Battery capacity.

For details of the tests see [Guidance for The Approval and Type Approval of Materials and Equipment for Marine Use \(Pt.1,Vol.W\)](#).

**4.5.3** Where the supply is to be maintained without a break following a power input failure, this is to be verified after installation by practical test.

## **E. Switchgear and Protection Devices**

### **1. General**

**1.1** Switchgear and protection devices shall be conformed to IEC Publications or to another standard recognized by BKI.

**1.2** For materials and insulation, see [Section 1.J](#).

**1.3** For equipment and components subject to mandatory type-approval, see [Section 5.H](#) and [Section 21.D](#) and [Section 21.E](#).

### **2. Medium-voltage switchgear**

For details of medium-voltage switchgear, see [Section 8](#).

### **3. Low-voltage switchgear**

#### **3.1 Circuit breakers**

##### **3.1.1 Drives**

- 1) Power-driven circuit-breakers shall be equipped with an additional emergency drive for hand operation.
- 2) Mechanical actuating elements on circuit-breakers for generators and essential circuits shall be so connected to the circuit-breakers that they cannot be lost.
- 3) Circuit-breakers with a making capacity exceeding 10 kA shall be equipped with a drive which performs the closing operation independently of the actuating force and speed (by snap action).
- 4) If the conditions for the closing operation are not fulfilled (e.g. under voltage release not energized), switching-on shall not cause the contact pieces to come into contact.

##### **3.1.2 Making and breaking capacity**

The making and breaking capacity shall be tested in accordance with IEC publication 60947-2. Other standards may be recognized.

#### **4. Protection devices**

##### **4.1 Short-circuit protection**

Short-circuit protection devices shall be independent of energy supplied from other circuits than those to be protected. In the event of a short circuit, the total break-down of the supply voltage shall be expected.

Short-circuit protection devices for generators shall be equipped with reclosing inhibitors, and shall be delayed for selective disconnection.

##### **4.2 Overcurrent protection**

The operation of overcurrent relays shall not be influenced by the ambient temperature. Thermal bimetallic relays shall be temperature compensated.

Overcurrent relays for motor protection shall be adjustable and provided with a reclosing inhibitor.

##### **4.3 Undervoltage protection**

Undervoltage relays shall cause the circuit-breaker to open if the voltage drops to 70 % - 35 % of the rated voltage. Undervoltage relays of generator circuit- breakers shall have a delay up to 500 ms.

##### **4.4 Shunt trips**

Shunt trips shall ensure the disconnection of the circuit-breakers even if the voltage drops to 85 % of the rated voltage.

##### **4.5 Electronic protection devices**

Electronic protection devices shall remain operative at their maximum permissible load at an ambient temperature of 55°C.

##### **4.6 Reverse power protection**

The reverse power protection device shall respond to the active power regardless of the power factor and shall operate only in the event of reverse power.

The response value and pick up time shall be adjustable.

The reverse power protection device shall remain operative despite a voltage drop to 60 % of the rated value.

##### **4.7 Phase failure protection**

Protection devices for detection of a single-phase failure in three-phase circuits shall operate instantaneously. Bimetallic relays with differential release do not constitute phase failure protection devices in the opinion of these Rules.

##### **4.8 Check synchronizers**

Check synchronizers for the protection of an alternator against parallel connection at an unacceptable phase angle shall allow parallel switching only up to an angular deviation (electrical) of 45° and up to a frequency difference of 1 Hz.

The check synchronizer shall ensure that parallel switching is impossible if the supply or measuring voltage fails or in the event of failure of any component.

#### 4.9 Insulation monitoring equipment

Devices for insulation monitoring of ships mains shall continuously monitor the insulation resistance of the network and shall release an alarm should the insulation resistance of the system fall below 50 Ω per volt of the operating voltage.

The measuring current shall not exceed 30 mA in the event of a dead short circuit to earth.

### F. Cables and Insulated Wires

#### 1. General

1.1 Cables and wires shall be flame-retardant and self-extinguishing.

1.2 If cable and wire types have passed a bundle fire test to IEC publication 60332-3, category A/F or IEEE 45-18.13.5, the installation of fire stops is dispensed with when laying in bundles (see also [Section 12.D.14](#), and SOLAS, Chapter II-1, Part D, Regulation 45.5.2).

1.3 Where fireproof cables shall be used, it is permitted to use cables with retention of insulating capability in accordance with IEC publication 60331 (see also [Section 12.D. 15](#)).

1.4 Cables manufactured in accordance with the relevant recommendations of IEC 60092-350:2020, 60092-352:2005, 60092-353:2016, 60092-354:2020, 60092-360:2014, 60092-370:2019 and 60092-376:2017 will be accepted by BKI provided that they are tested to its satisfaction.

Cables manufactured and tested to standards other than those specified like above mentioned will be accepted provided they are in accordance with an acceptable and relevant International or National Standard and are of an equivalent or higher safety level than those listed in [1.4](#). However, cables such as flexible cable, fibre-optic cable, etc. used for special purposes may be accepted provided they are manufactured and tested in accordance with the relevant standards accepted by BKI.

#### 2. Conductor material and structure

2.1 Electrolytic copper with a resistivity not exceeding 17,241 Ω mm<sup>2</sup>/km at 20 °C shall be used as the material for the conductors of cables and wires.

2.2 If the insulation consists of natural or synthetic rubber vulcanized with sulphur, the individual conductor wires shall be tinned.

2.3 The conductors of movable wires shall be finely stranded.

The conductors of permanently laid cables and wires shall be made of stranded copper conductors (class 2) or flexible stranded copper conductors (class 5).

Solid conductors up to 4 mm<sup>2</sup> in cross-section are permitted for final sub circuits of room lighting and space heating systems in the accommodation and for special cables of TV and multimedia applications.

#### 3. Materials and wall thickness of insulating covers

3.1 The materials used for insulation shall be of standardized types for which the maximum permissible temperatures at the conductors during undisturbed operation are specified.

#### 4. Protective coverings, sheaths and braids

4.1 Single-core cables shall have a suitable separating layer of filler material or foil over the core insulation.

4.2 Multicore cables shall have a common core covering made of filler material or shall have a wrapping and sheath.

4.3 Only materials of a standardized type shall be used for non-metallic sheaths. In all cases the thermal stability of the compounds used shall correspond to that of the insulating material.



4.4 Braids shall be made of corrosion-resistant material such as copper or copper alloy or of material treated to prevent corrosion, e.g. galvanized steel.

4.5 Outer metallic wire braids shall have a coating of protective paint, which shall be lead-free and flame-retardant. The paint shall be of sufficiently low viscosity when applied to enable it to penetrate readily into the wire braid. When dry, it shall not flake off when the cable is bent around a mandrel with a diameter of 15 times that of the cable.

## 5. Identification

5.1 Each cable shall be marked for type and for name of the manufacturer.

5.2 The cores of multicore cables and wires shall have a permanent marking. In multicore cables and wires where the cores are arranged in a number of concentric layers, two adjacent cores in each layer shall be coloured differently from each other and from all other cores, unless the individual cores are otherwise unambiguously identified, e.g. by printed numbers.

5.3 Protective earth conductors shall have green/ yellow colour coding.

## 6. Approvals

6.1 Cables and wires are subject to mandatory type approval by BKI.

6.2 Proof is required by the manufacturer by issue of workshop test reports stating that the continuous production is made in conformity to relevant standards and is verified by individual and sample tests for each production length of cables. These reports shall record any deviations from the standards.

6.3 The application of cables and wires without type-test is subject to an agreement with BKI in every case. Individual and sample tests performed at the manufacturer's works on each length delivered are required for these cables (see 7.3).

## 7. Tests

7.1 Type tests shall be carried out in accordance with the relevant standards in the manufacturer's works and in the presence of the Surveyor of the Head Office. The scope of the tests shall be agreed with BKI.

7.2 If not specified in the standards, the tests according to [Guidance for Approval and Type Approval of Materials and Equipment for Marine Use \(Pt.1, Vol.W\) Sec.3.T](#) shall be performed as an additional requirement.

Other equivalent test methods may be agreed with BKI.

The test is passed satisfactory if no cracks will be discovered visible to the naked eye.

7.3 Individual tests on non-type-tested cables and wires shall be performed in the manufacturer's works in the presence of the Surveyor.

The scope of the tests shall be agreed with BKI in advance.

The following tests shall be carried out at least:

- conductor resistance
- dielectric strength
- insulation resistance
- dimensions and construction of samples
- mechanical strength characteristics of samples

## G. Cable Penetrations and Fire Stops

### 1. Bulkhead and deck penetrations

- 1.1 The sealing compounds and packing systems shall be type-tested by BKI.
- 1.2 The requirements for bulkhead and deck penetrations are stated in [Section 12.D.8](#).
- 1.3 The type test shall be performed in the presence of the Surveyor to the Head Office in the manufacturer's works or in independent institutions, according to the [Guidance for Approval and Type Approval of Materials and Equipment for Marine Use \(Pt.1, Vol.W\) Sec. 3.K](#).

### 2. Fire stops

- 2.1 The requirements for fire stops using partitions or coatings are listed in [Section 12.D.14](#).
- 2.2 The construction of fire stops using coatings is subject to a type test in the presence of the Surveyor to the Head Office in the manufacturer's works or in independent institutions.

The test requirements shall be agreed with BKI.

## H. Installation Material

### 1. General

- 1.1 The installation material shall conform to IEC publications. Other standards may be recognized by BKI.
- 1.2 It is necessary to ensure that terminals are suitable for the connection of stranded conductors. Exceptions are permitted for systems with solid conductors (e.g. lighting, socket-outlets and heating appliances in the accommodation area).
- 1.3 For materials, see [Section 1. J](#).

### 2. Plug-and-socket connections

- 2.1 Depending on their application, the design of plug-and-socket connections shall conform to the following regulations:
  - in the accommodation area, day rooms and service rooms (up to 16 A, 250 V AC) - IEC publication 60083 or 60320
  - power circuits (up to 250 A, 690 V AC) - IEC publication 60309-1 and 60309-2
  - electronic switchgear - IEC publications, e.g. 60130 and 60603
  - refrigerated containers - ISO 1496-2

## I. Lighting Fixtures

### 1. General

Luminaires, floodlights and searchlights shall conform to IEC publications 60598 and 60092-306. Other standards may be recognized by BKI.

The requirements stated in [H.1](#) shall be observed.

### 2. Design

- 2.1 The surface temperature of easily touchable parts of lighting fixtures shall not exceed 60 °C.
- 2.2 High-power lights with higher surface temperatures shall be protected against unintentional contact by additional means.

2.3 Lighting fittings shall be so arranged as to prevent temperature rises which could damage the cables and wiring, and to prevent surrounding material from becoming excessively hot.

2.4 The terminals and spaces for the connection of cables shall not reach a higher temperature permissible for the insulation of the wires or cables used. The temperature rise in the terminal box shall not exceed 40 K.

2.5 All metal parts of a lighting fixture shall be bounded together.

2.6 Wiring inside lighting fixtures shall have a minimum cross-section of 0,75 mm<sup>2</sup>. A cross-section of at least 1,5 mm<sup>2</sup> shall be used for through wiring.

Heat-resistant wires shall be used for internal wiring.

2.7 Each lighting fixture shall be durably marked with the following details:

- maximum permitted lamp wattage
- minimum mounting distance

## J. Electrical Heating Equipment

### 1. General

1.1 Electrical heating equipment and boilers shall conform to IEC publications, e.g. 60335, with particular attention to IEC publication 60092-307. In addition, the general assignments in H.1. shall be observed.

1.2 The connections of power supply cables shall be so arranged that temperatures higher than permitted for the terminals and supply cables do not arise.

1.3 Controls in operation such as switch knobs and handles shall not attain temperatures higher than

- 55 °C for metal parts or
- 65 °C for parts made of porcelain, glass, moulded plastics or wood.

A temperature of 5 °C higher is permissible for parts operated by finger tipping only.

1.4 Only heating elements with shrouding or ceramic-embedded heating coils shall be used. Infrared radiators are permitted.

### 2. Design

#### 2.1 Space heaters

2.1.1 The casing or enclosure of each heater shall be so designed that no objects can be placed on it, and the air can circulate freely around the heating elements.

2.1.2 Electrical space heaters shall be so designed that, based at an ambient temperature of 20 °C, the temperature of the casing or enclosure and of the air flow from the heater does not exceed 95 °C under defined test conditions.

2.1.3 To prevent unacceptable temperature rises due to heat accumulation, each heater shall be fitted with a safety temperature limiter. Automatic reconnection is not permitted.

The safety temperature limiter may be dispensed with for watertight heaters in spaces without a substantial fire risk, e.g. in bathrooms and washing rooms.

2.1.4 The operating switches shall disconnect all live conductors. The switch positions shall be clearly marked at the switches.

## 2.2 Passage heaters and boilers

Passage heaters and boilers shall be equipped with two mutually independent thermal protection devices, one of them shall be a permanently set safety temperature limiter, the other may be a thermostatic controller.

Automatic reconnection of the safety temperature limiter is not permitted.

## 2.3 Electric ranges and cooking facilities

**2.3.1** Only enclosed-type hot plates shall be used. It shall not be possible for liquids to penetrate into the electrical equipment.

**2.3.2** The switches for the individual plates and heating elements shall disconnect all live conductors. The switch steps shall be clearly marked.

**2.3.3** Internal connections shall be made of heat-proof terminals and wiring, and shall be corrosionresistant.

## 2.4 Deep-fat cooking equipment

Deep-fat cooking equipment shall be fitted with the following arrangements:

- an automatic or manual fire-extinguishing system tested to an international standard<sup>1)</sup>
- a primary and backup thermostat with an alarm to alert the operator in the event of failure of either thermostat
- arrangements for automatically shutting-off the electrical power upon activation of the fire extinguishing system
- an alarm for indicating operation of the fire-extinguishing system in the galley where the equipment is installed
- controls for manual operation of the fire extinguishing system which are clearly labelled for ready use by the crew

---

<sup>1)</sup>Reference ISO 15371:2000 "Fire-extinguishing systems for protection of galley deep-fat cooking equipment"

## Section 21 Test

A.	General . . . . .	21-1
B.	Examinations of Technical Documentation . . . . .	21-1
C.	Tests in the Manufacturer's Works . . . . .	21-1
D.	Tests on Board . . . . .	21-3
E.	Type Approvals . . . . .	21-5

### A. General

1. The following Rules apply to the testing of electrical and electronic installations, equipment and components.
2. Within the framework conform to the specified requirements of their general quality assurance programme, manufacturers shall ensure that the products they manufacture.

Records shall be made, containing quality-assurance measures and tests and shall be handed over to BKI on request.

3. For certain installations, equipment and components, testing is required in the presence of the Surveyor according to these Rules, see [C](#), [D](#) and [E](#).

The tests and items for testing specified below constitute minimum requirements.

BKI reserve the right to demand that tests also be performed on other items, either on board or in the manufacturer's works.

4. For appliances of a new type or for equipment which is being used for the first time on ships with BKI Class, additional tests and trials are to be agreed between the manufacturer and BKI, if the circumstances this require.
5. It is the aim of the tests to verify conformity with the requirements covered by the Rules for Construction, and to prove the suitability of equipment for its particular application.
6. Tests are divided into:
  - examinations of the technical documentation, see [B](#).
  - tests in the manufacturer's works, see [C](#).
  - tests on board, see [D](#).
  - tests for type approvals, see [E](#).

### B. Examinations of Technical Documentation

1. The list of documents subject to approval is specified in [Section 1, C](#).
2. The documents which have been examined and approved shall be presented to the Surveyor on request.

### C. Tests in the Manufacturer's Works

#### 1. Tests in the presence of the Surveyor

- 1.1 The tests shall be carried out on the basis of the Rules for Construction and the approved documents. They shall be performed in accordance with a recognized standard.

1.2 Machines, appliances and installations subject to testing in accordance with 2 are to be tested in the presence of the Surveyor unless the preconditions for one's own responsibility tests by the manufacturer are fulfilled, see 3.

## 2. Machines, appliances and installations subject to testing

### 2.1 Electrical machines: for scope of tests, see Section 20, A.

- 1) Generators and motors for electric propulsion plants
- 2) Generators and motors for essential equipment, or if they are necessary for the preservation of the cargo/ship's safety, e.g. for Class Notation **RIC**, **RCP x/y**, compressors for gas tanker, circulating pumps for sea operation etc.  $P \geq 100 \text{ kW/ kVA}$
- 3) Transformers  $P \geq 100 \text{ kVA}$
- 4) Autotransformers  $P \geq 100 \text{ kVA}$

### 2.2 Power electronics

For scope of tests, see Section 6, G.

- 1) For electric propulsion plants, see Section 13, K.
- 2) For essential equipment  $P \geq 50 \text{ kW/ kVA}$ .
- 3) For battery charging  $P \geq 2 \text{ kW}$ .

### 2.3 Switchboards

For scope of tests, see Section 5, F and Section 8, E. and check list form F21.8.01.

- 1) Main switchboards
- 2) Emergency switchboards
- 3) Switchboards for electric propulsion plants
- 4) Switchboards for operation of equipment with Class Notation, e.g. cargo-refrigerating systems **RIC**
- 5) Distribution switchboards with connected power  $\geq 500 \text{ kW}$
- 6) Starters for motors in accordance with 2.1 b)

### 2.4 Steam boilers and thermal oil systems

Scope of tests, see Section 5, H.

### 2.5 Electrical propulsion plants

Scope of tests, see Section 13.

### 2.6 Computer systems

Scope of tests, see Section 10.

### 3. One's own-responsibility tests made by the manufacturers

3.1 The products under 2.1 2), 3), 4), 2.2 2), 2), 3) and 2.3.4), 5), 6) may be tested on the manufacturer's own responsibility if the following preconditions are fulfilled:

- A QM system recognized by BKI is available.
- BKI has carried out type tests of the products.
- The one's-own responsibility tests have been agreed with BKI.

3.2 Reference is made to the [Guidance for The Approval and Type Approval of Materials and Equipment for Marine Use \(Pt.1, Vol.W\)](#).

## D. Tests on Board

### 1. General

The tests are divided into:

- tests during construction/installation
- tests during dock trials
- tests during dock trials

### 2. Tests during construction

2.1 During the period of construction of the ship, the installations shall be checked for conformity with the documents approved by BKI and with the Rules for Construction.

2.2 Test certificates for tests which have already been performed shall be presented to the Surveyor on request

2.3 Protective measures shall be checked:

- 1) protection against foreign bodies and water.
- 2) protection against electric shock, such as protective earthing, protective separation or other measures as listed in [Section 1](#).
- 3) measures of explosion protection. The design shall conform to the details on form "Details about the construction of electrical equipment in hazardous areas", submitted by the shipyard for approval.

### 2.4 Testing of the cable network

Inspection and testing of cable installation and cable routing with regard to

- 1) acceptability of cable routing with regard to
  - separation of cable routes
  - fire safety
  - the reliable supply of emergency consumers
- 2) selection and fixation of cables
- 3) construction of watertight and fireproof bulkhead and deck penetrations
- 4) insulation resistance measurement.
- 5) For medium-voltage installations, see [Section 8](#).

### 3. Tests during dock trials

#### 3.1 General

Proofs are required of the satisfactory condition and proper operation of the main and emergency power supply systems, the steering gear and the aids of manoeuvring, as well as of all the other installations specified in the Rules for Construction.

Unless already required in the Rules for Construction, the tests to be performed shall be agreed with the Surveyor in accordance with the specific characteristics of the subject equipment.

#### 3.2 Generators

**3.2.1** A test run of the generator sets and as far as possible of the shaft generators shall be conducted under normal operating conditions and shall be reported on form.

**3.2.2** For ships, where electrical power is necessary to restore propulsion, it shall be proved that after black-out and dead ship condition (see [Section 3, B.1.7](#) and [1.8](#) together with [C.1.4](#)) the propulsion to the ship in conjunction with required machinery can be restored within 30 minutes after black-out.

#### 3.3 Storage batteries

The following shall be tested:

- 1) installation of storage batteries
- 2) ventilation of battery rooms and boxes, and cross-sections of ventilation ducts
- 3) storage-battery charging equipment
- 4) the required caution labels and information plates

#### 3.4 Switchgear

The following items shall be tested.

- 1) accessibility for operation and maintenance
- 2) protection against the ingress of water and oil from ducts and pipes in the vicinity of the switchboards, and sufficient ventilation
- 3) equipment of main and emergency switchboards with insulated handrails, gratings and insulating floor coverings
- 4) correct settings and operation of protection devices and interlocks
- 5) independent manual operation of generating sets from common external voltage and automation systems (manual operation means local start/ stop and speed setting as well as voltage control, protection devices and synchronizing from switchboard)

BKI reserves the right to demand the proof of selective arrangement of the ship supply system.

#### 3.5 Power electronics

The following items shall be tested:

- 1) ventilation of the place of installation
- 2) function of the equipment and protection devices



### 3.6 Power plants

The following items shall be tested:

- 1) Motor drives together with the driven machines, which shall, wherever possible, be subjected to the most severe anticipated operating conditions. This test shall include a check of the settings of the motors short-circuit and overcurrent protection devices.
- 2) the emergency remote shut-downs (see [Section 4, I. 8](#)) of equipment such as
  - engine room fans
  - fuel pumps
  - separators
  - boiler blowers, etc.
- 3) closed loop controls, open loop controls and all electric safety devices

### 3.7 Control, monitoring and ship's safety systems

For these systems, operational tests shall be performed

### 3.8 Electrical propulsion plants

Regarding scope of tests, see [Section 13](#).

### 3.9 Computer systems

Regarding scope of tests, see Section 10.

## 4. Tests during the sea trial

### 4.1 Rating of the main and emergency electrical power supplies

During the sea trial, it shall be proved that the main and emergency electrical power supplies are adequately rated and conform to [Section 3](#) and all control and monitoring devices are functioning according to their assignments.

### 4.2 Operating reliability during navigation

**4.2.1** Tests shall be carried out to determine whether all the machines, equipment etc. constituting the electrical installation operate satisfactorily at all revolutions of the main engine, particularly during engine and steering gear manoeuvres.

**4.2.2** Tests shall be carried out on the restoration of the main and emergency electrical power supplies following a black-out during navigation.

**4.2.3** Tests shall be made of network quality in distribution systems supplied by semiconductor converters and in distribution systems with prevailing load consumption by semiconductor converters.

### 4.2.4 Electrical propulsion plants

Regarding scope of tests, see [Section 13](#).

## E. Type Approvals

1. The installations, equipment and assemblies mentioned in 5 are subject to mandatory type approval.
2. Type approvals shall be coordinated by Head Office and executed either in the manufacturer's works or, by agreement, in suitable institutes.

3. Type approvals are carried out according to the [Guidance for The Approval and Type Approval of Materials and Equipment for Marine Use \(Pt.1, Vol.W\)](#) and defined standards.

4. Type tested installations, apparatuses and assemblies shall be used within the scope of valid Construction Rules only. The suitability for the subject application shall be ensured.

### 5. Installations, apparatuses and assemblies subject to type testing

#### 5.1 Electrical installations

##### 5.1.1 Cables and accessories

- 1) Cables and insulated wires
- 2) Sealing compound and packing systems for bulkhead and deck penetrations
- 3) Busbar trunking systems for the installation
- 4) Cable trays/protective casings made of plastic materials are to be type tested in accordance with IACS UR E 16; see [Section 12, D.6](#).

For guidance on testing, refer to [Guidance for Marine Industry \(Pt.1, Vol.AC\) Sec.4 R-73](#)

##### 5.1.2 Switchgear, see [Section 5, H](#).

- 1) Circuit-breakers, load switches, disconnect switches and fuses for direct connection to the main busbars or non-protected distribution busbars of main, emergency and propulsion switchboards
- 2) Standardized switchgear units manufactured in series with reduced clearance and creepage distances, see [Section 5, F.3.2](#)

##### 5.1.3 Generator / mains supply protection devices, see [Section 4, A](#).

- 1) Short-circuit protection
- 2) Overcurrent protection
- 3) Reverse-power protection
- 4) Automatically synchronizing device
- 5) Under frequency protection
- 6) Over- and under voltage protection
- 7) Differential protection
- 8) Earth fault monitoring

#### 5.2 For steering gear and rudder-propeller systems, see [Section 7, A](#).

##### 5.2.1 Input devices such as

- 1) Phase failure relays
- 2) Level sensors

##### 5.2.2 Steering gear control systems with all components important for the function, e.g.

- 1) Steering mode selector switch
- 2) Follow up/ non-follow up control devices

#### 5.3 Variable pitch propeller controls with all components important for the functioning.

**5.4** Machinery control systems, see [Section 9](#)

- 1) Open and closed loop control for speed and power of internal combustion engines (main and auxiliary engines) and electrical actuators, see also [Section 9, B.8](#).
- 2) Safety devices
- 3) Safety systems

**5.5** Ship's control and safety systems, see [Section 9, C](#) and [Section 9, D](#) and [Section 7, G](#).

- 1) Fire detection and alarm systems
- 2) Suction-type smoke-detection systems
- 3) Loading instrument (loading computer), see [Rules for Hull \(Pt.1, Vol. II\), Sec. 5, A.4.1.3](#)
- 4) Automatic stop devices and control units for heel compensation systems, see [Section 7, G](#).
- 5) Flame detectors, remotely controlled valves, control electronics and fire detection systems for fixed water-based local application fire-fighting systems (FWBLAFFS, see [Section 9, D](#))
- 6) Combustion engine crankcase oil mist detection monitoring device/system

**5.6** For tankers, see [Section 15](#).

- 1) Tank level gauging equipment
- 2) Tank level alarm equipment
- 3) Overfill protection devices
- 4) Tank pressure monitoring systems
- 5) Required gas detectors and systems

**5.7** Water ingress detection system for bulk carriers, see [Section 18](#).

**5.8** For ships with RIC Class Notation, see [Rules for Refrigerating Installations \(Pt.1, Vol. VIII\)](#).

Input devices and actuators

**5.9** Electrically supplied LLL-systems.

**5.10** Computer systems, see [Section 10](#).

**5.11** Installations, applied by the rules for construction for automated and/or remotely controlled systems, see [Rules for Automations \(Pt.1, Vol. VII\), Sec. 7, E](#).

**5.12** Monitoring, protection and management systems of battery systems, according to [Section 2.C.2](#).

**6. Exceptions**

**6.1** Instead of the stipulated type approvals in well-founded cases routine tests in the presence of the Surveyor may be carried out. An agreement with BKI prior to testing is required.

**6.2** Individual tests for cables and wires are specified in [Section 20, F](#).

*This page intentionally left blank*

## Section 22 Spare Part

1. In order to be able to restore machinery operation and manoeuvring capability of the ship in the event of a damage at sea, spare parts for the main propulsion plant and the essential equipment shall be available aboard of each ship together with the necessary tools.
2. The amount of spare parts shall be documented, and a corresponding list shall be carried aboard.

*This page intentionally left blank*

## Section 23 Additional Rules for Storage of Electrical Power

A.	General . . . . .	23-1
B.	Definitions . . . . .	23-1
C.	Further rules and standards to be considered . . . . .	23-1
D.	Documents to be submitted . . . . .	23-2
E.	Battery system . . . . .	23-5
F.	Class Notation SEP (Power) . . . . .	23-10
G.	Class notation SEP(Propulsion) . . . . .	23-17

### A. General

#### 1. Scope and Application

1.1 This Section facilitates the use of the storage of electrical power (SEP) installations onboard electric and hybrid ships.

1.2 The rules in this section cover design, installation and certification requirements for lithium-ion battery systems.

1.3 Since commercial SEP technologies are continuously evolving, the additional requirements for the battery may be required by BKI on a case-by-case basis. Deviation from the rules may be approved, provided that it can be demonstrated that the design represents an equal or better level of safety.

1.4 The additional class notation SEP sets the requirement for the safety and availability of SEP installations onboard vessels.

1.5 Where the ships complying with the requirements in this section, the additional class notation SEP(Propulsion) for ships where SEP is used for electrical propulsion or SEP(Power) for SEP used as electric power supply purpose used when the ship in service will be assigned.

### B. Definitions

For the purpose of these Rules the definitions in [Table 23.1](#) are applied.

### C. Further rules and standards to be considered

#### 1. Rules and Guidelines

Further Rules and Guidelines of BKI mentioned in this Section are to be observed.

#### 2. National and International Codes

The test requirements for SEP systems is partly based on the following standards:

- IEC 60092-101 Electrical installations in ships - Definitions and general requirements.
- IEC 62619 Secondary cells and batteries containing alkaline or other non-acid electrolytes - Safety requirements for secondary lithium cells and batteries, for use in industrial applications.

- IEC 62620 Secondary cells and batteries containing alkaline or other non-acid electrolytes - Secondary lithium cells and batteries for use in industrial applications.

**Table 23.1: Definition**

Item	Description
Battery cell	smallest building block in a battery containing electrochemical device composed of positive and negative plates, separator, and electrolyte which is capable of storing electrical energy.
Battery module	of battery cells that are connected together including electronic control
Battery pack	any sets of modules including complete BMS and can be used as a standalone unit
Battery system	complete battery installation including battery modules, battery management system, monitoring and sensing, electrical interconnections, and other safety features
Battery management system	an electronic system associated with a battery pack which controls, monitors and manages the state of the battery by protecting the battery from operating outside its safe operating limits.
SEP Converter	equipment controlling the charging and discharging of the SEP system
State of Charge (SOC)	the remaining electricity available in the cell expressed in percentage
State of Health (SOH)	indication of level of degradation and remaining capacity of the battery relative to a fresh battery
SEP space	storage space for lithium-ion batteries
SEP system	whole SEP installation including modules, electrical interconnections, control management system and other safety features
Off-gas	gasses released from SEP cell(s) during an abnormal incident (vaporised electrolyte, thermal runaway exhaust gas)
Sealed battery	battery that remains closed and does not release either gas or liquid when operated within the limits specified by the manufacturer
Thermal runaway	accelerating self sustained temperature increase

#### D. Documents to be submitted

1. The drawings and documents listed in [Table 23.2](#) for the SEP(Power) notation and with additional documentation in [Table 23.3](#) for the SEP(Propulsion) notation are to be submitted for examination.
2. When the risk assessment is carried out for the installations of the battery, the following documents are to be submitted to BKI for approval:
  - Structural fire protection
  - Ventilation/exhaust systems
  - Fire detection arrangement
  - Gas detection system
  - Fixed fire extinguishing system



3. BKI reserve the right to demand additional documentation if that submitted is insufficient for an assessment of the installation.

**Table 23.2: Documentation for approval and information for notation SEP(Power)**

No.	Documents	Description	Info
<b>1</b>	<b>Battery spaces</b>		
1.1	Arrangement plan	Arrangement of battery system and other equipment inside the battery space(s) including ventilation and possible gas detection.	FI
1.2	Safety philosophy	Safety philosophy for the battery space(s), see <a href="#">F.6</a> .	FI
1.3	Structural fire protection drawing		AP
1.4	Fire control plan	Plan for firefighting appliances and escape	AP
1.5	Fixed fire extinguishing system	Fixed total flooding fire-extinguishing system for the battery space(s).	AP
1.6	Arrangement plan	Arrangement of the fire detection in the battery space(s).	AP
1.7	System block diagram	Fire detection system, if applicable, gas detection system, see <a href="#">F.4.3</a>	AP
1.8	Ducting diagram for the ventilation system	Detailed arrangements of the ventilation ducts and openings serving the battery space(s).	AP
1.9	Operation manual	See <a href="#">F.8.1</a> and for vessels with SEP(Propulsion) notation <a href="#">G.4.1</a> .	FI, L
1.10	Maintenance manual	See <a href="#">F.8.2</a> and for vessels with SEP(Propulsion) notation <a href="#">G.4.2</a> .	FI, L
<b>2</b>	<b>Battery systems</b>		
2.1	System block diagram	Block diagram of battery system and interface with: converters power management system battery management system (BMS) alarm system emergency shutdown other systems	AP
2.2	Functional description	Description of function of control and safety system of the battery, as instance battery management system, power management system, protective system, shutdown arrangement, etc.	AP
2.3	Risk assessment	Risk analysis consisting of identification of all potential hazard, of the battery risk evaluation, risk treatment to control and minimize the identified risk.	AP
2.4	Test program	Test programs for manufacturer test, onboard and sea trial test.	AP
<b>3</b>	<b>Main power system</b>		
3.1	Electrical load balance	Calculation of electrical load balance, size of the battery, size and capacity of converter, and charge/discharge capacity.	AP

AP = For Approval; FI = For Information; L = Local Handling

**Table 23.3: Documentation for approval and information for notation SEP(Propulsion)**

No.	Documents	Description	Info
<b>1</b>	<b>Main power system</b>		
1.1	Electrical load balance	Calculation of the available power for the propulsion after worst case failure, see <a href="#">G.2.2.2</a> .	AP

AP = For Approval; FI = For Information;

#### 4. Onboard documentation

The builder shall provide the documentation required by [Table 23.4](#) for use onboard the vessel.

**Table 23.4: Onboard documentation**

Object	Documentation type	Additional description
SEP spaces	Operation manual	See <a href="#">F.8.1</a> and for ship with SEP(Power) notation <a href="#">G.4.1</a> .
	Maintenance manual	See <a href="#">F.8.2</a> and for ship with SEP(Propulsion) notation <a href="#">G.4.2</a> .

**5. Component certification**

Components required to be delivered with the BKI’s product certificate shall be documented as described in [Table 23.5](#)

**Table 23.5: Component certification, documentation requirements**

Object	Documentation type	Additional description	Info
Lithium-ion battery system	Safety description	See <a href="#">E.1.2.1</a>	AP
	Specification	Including ratings and environmental data. Short circuit current capacity shall be stated for both maximum (fully charged new battery) and minimum (discharged battery at estimated end of lifetime) capacity.	AP
	Electrical schematic drawing	Schematic drawing of the battery system showing the battery packs, strings and modules, including switchgear and control gear.	AP
	Test procedure at manufacturer	See <a href="#">E.2</a> .	AP
	Test report	Type test report from testing of battery cells, if the battery system is not type approved, see <a href="#">Table 23.6</a> .	FI
	Report from test at manufacturer	Type test report from testing of the battery system, if the battery system is not type approved <a href="#">Table 23.7</a> .	FI
	Control system functional description	Battery management system (BMS)	AP
	System block diagram (topology)	Battery management system (BMS)	AP
	Power supply arrangement	Battery management system (BMS)	AP
	Datasheet with environmental specifications	Battery management system (BMS)	AP
	List of controlled and monitored points	Battery management system (BMS)	AP
	Circuit diagram	Battery management system (BMS)	AP
	Software change handling procedure	Battery management system (BMS)	AP
	Calculation report	Documentation of the SOH and SOC calculation	FI

**Table 23.5: Component certification, documentation requirements (continued)**

Object	Documentation type	Additional description	Info
Energy management system	Control and monitoring system documentation	See <a href="#">E.1.5</a>	AP
SEP converter	References in <a href="#">C.</a> is to be observed		
AP = For Approval; FI = For Information			

## 6. Survey and testing requirements

6.1 Requirements for newbuilding survey are found in [F.7](#) and [G.3](#).

6.2 Requirements for survey of the lithium-ion batteries at manufacturers are found in [E](#).

## E. Battery system

### 1. Battery system design

#### 1.1 General

The requirements in this sub-section are applied to lithium-ion battery systems. Battery with other chemistry compositions will be considered on a case-by-case basis. The main principles in this section will be applied.

#### 1.2 Battery safety

1.2.1 All hazards shall be described in a battery system safety description. Safety precautions mitigating the identified risks shall be included. The safety description shall cover all potential hazards represented by the type (chemistry) of battery including:

- safety philosophy
- potential gas development (toxic, flammable, corrosive)
- fire risk
- explosion risk, including a description of the gas that can be released from the cell(s) during venting and thermal runaway (gas volume, release rate and gas composition)
- necessary detection, monitoring and alarm systems (gas detection, fire detection etc.) and ventilation rates for the battery space
- a suitable fire extinguish method shall be given
- internal cell failure/thermal runaway
- internal and external short circuit and earth faults
- electrical protections (over current, over voltage and under voltage)
- protection against creeping current, electrical arcing and electrolysis due to external leakage or pollution
- flooding of battery modules due to cooling liquid leakage

- external heating/fire
- safe charging/discharging characteristics.

**1.2.2** The battery system shall have an integrated battery management system (BMS). See [E.1.4](#) for details.

**1.2.3** The BMS shall communicate the voltage and current limits to the battery converter.

**1.2.4** The battery system's main power contactors or circuit-breakers shall disconnect both poles.

**1.2.5** The battery system shall be equipped with an independent emergency shutdown for disconnection of the battery system.

**1.2.6** For sealed batteries, a safety pressure valve or other means of explosion protection (weak point) shall be included in the battery design.

**1.2.7** The design of a module should prevent propagation of a thermal event from the first cell to another cell. Alternatively, as a minimum, a system shall be designed such that a fire in one cell may spread within that module but will not propagate to another module. The amount of off-gas considered in analysis shall be dependent on the number of cells which release off-gas. Demonstration of system capability with respect to either approach shall be verified by testing as defined in [E.2.2](#) in accordance with one of these two options:

- 1) No propagation between cells within a module.
- 2) No propagation between modules - with or without an extinguishing agent.

Design option 2 is only accepted where the sum of the cells that propagate in the module is limited to 11 kWh. Modules that are designed to limit propagation of a thermal event within a cell block or a sub-unit of cells shall be assessed on a case by case basis.

**1.2.8** The main power connectors shall have an integrated safety interlock (HVIL), securing that connection/disconnection only can be performed when the battery contactor is open.

**Note**

*HVIL is not required for fixed (bolted) connections.*

**1.2.9** The clearance and creepage distances as given in [Section 1.J.2](#) shall be met based on the end of charge voltage for the battery system.

**1.2.10** Battery modules shall be designed such that the risk of a cooling liquid leakage inside the module is minimized and do not lead to hazardous creepage currents, electrolysis, short circuit, electric arcing, earth faults or other hazards. Leakage detection inside the module shall be arranged if there is liquid cooling inside the module.

**1.2.11** Battery systems shall be designed such that the risk of cooling liquid leakage in the battery system is minimized and do not lead to hazardous creeping currents, electrolysis, short circuit, electric arcing, earth faults or other hazards. Leakage detection shall be arranged.

**Note**

*All main electrical connections should be located at the top of the system as far as possible.*

### **1.3 Safety functions**

**1.3.1** Activation of protective safety functions shall give alarm. Failures in the protective safety system rendering the safety function out of operation shall be detected and give alarm in accordance with [Section 9.A](#).

**1.3.2** The battery modules shall be equipped with an overcharge protection independent of the BMS. This independent protection shall be arranged either by:

- temperature monitoring
- voltage monitoring.

This protection shall be arranged with components independent from those used for the indication, alarm, control functions and protection functions required by 1.4 and 1.5. For systems with cells provided with CID or similarly functioning devices, the requirement for independent overcharge protection is considered met. If temperature sensors are arranged in close vicinity in the battery module so that loss of functionality of a broken sensor element or circuitry will be mitigated by a neighbouring sensor, the sensor element/circuitry may be common for the indication, alarm, control and protection functions required under 1.4 and 1.5 and independent overcharge protection. Such arrangements shall still be designed with independency for CPUs and other electronic parts of the independent overcharge protection, i.e. no single failure shall affect both functions.

**1.3.3** Other fail-safe and independent protective functions shall be implemented if the battery type or design used comprises additional hazards.

#### **1.4 Battery management system**

**1.4.1** The battery management system (BMS) shall:

- provide limits for charging and discharging to the battery converter
- protect against over-current, over-voltage and under-voltage by disconnection of the battery system
- protect against over-temperature by disconnection of the battery system
- provide cell and module balancing

**Note**

*Protection of over current may also be done by limiting the current from the battery converter.*

**1.4.2** The following parameters shall be measured:

- cell voltage
- cell or module temperature
- battery string current.

**1.4.3** The following parameters shall be indicated at local control panels or in remote workstations:

- system voltage
- max, min and average cell voltage
- max, min and average cell or module temperature
- battery string current.

**Note**

*The values may be calculated in an external system.*

**1.4.4** The following parameters shall be calculated and be available for the energy management system (EMS):

- state of charge of the batteries (SOC)
- state of health of the batteries (SOH).

## 1.5 Battery alarms

**1.5.1** Any abnormal condition in the battery system shall initiate an alarm in the vessel's main alarm system with individual or group-wise indication in accordance with [Section 9.D](#). For vessels without a centralized main alarm system, battery alarms shall be presented at the bridge. This shall include at a minimum:

- high cell or module temperature
- over and under voltage
- battery disconnection
- tripping of battery breakers/contactors
- communication alarm
- liquid cooling leakage
- other safety protection functions.

For battery systems that are designed with independent overcharge protection based on voltage monitoring of the modules (see [1.3.2](#)) unbalanced cell voltage is also required. Abnormal conditions that can develop into safety hazards shall be alarmed before reaching the hazardous level. Sensors and other components used for such alarms shall be separate from emergency shutdown or other protective safety functions.

### Note

*General requirements for protective safety action, automatic or manual shutdown can be found in [Section 9.D](#).*

## 1.6 Materials

The battery system shall be made of a flame-retardant material according to IEC 60092-101.

## 1.7 Ingress protection

The requirements for IP rating of the battery systems depends on the location. As a minimum, IP 44 is required. IP rating below IP 44 may be accepted based on a risk evaluation of the battery installation. The risk evaluation should particularly consider intrusion of salt water, as salt water is the last resort of fire extinguishing on board a sea going vessel.

## 2. Testing

### 2.1 General

A test program for functional and safety tests at manufacturer shall be submitted for approval before testing.

### 2.2 Propagation testing

Propagation requirements are taken as defined in IEC 62619 (§7.3.3 and Appendix B) modified to one of the following two design options:

- 1) The battery system is designed for no propagation between cells within a module.
  - The test shall be repeated 3 times and successful each time.
  - The test shall be performed within an ambient temperature of the maximum operating temperature (+/-5°C) for the battery system.

- All cells within the module must be electrically connected, except if overcharge method is used for initiate the thermal runaway, then the cell being overcharged can be electrical disconnected.
  - The module shall be considered under test for 24 hours after thermal runaway.
  - If a coolant media is used to prevent propagation it shall be automatically released. It shall be tested in the same configuration with which it will be installed.
  - If a coolant media is used to prevent propagation it shall be automatically released. It shall be tested in Acceptance criteria is defined as only the cell which is directly caused to fail by testing show fire or off gassing and that all other cells in module show no external signs of thermal runaway and still produce a measurable voltage within normal operating range. Neighbouring cells equipped with CID may have no measurable voltage if the cells' CID is activated due to high temperature. For such cells, it is acceptable that the voltage is not measurable.
- 2) The battery system is designed for no propagation between modules with or without an extinguishing agent.
- The test shall be repeated 3 times and successful each time.
  - The test shall be performed within an ambient temperature of the maximum operating temperature (+/-5°C) for the battery system.
  - All cells within the module must be electrically connected, except if overcharge method is used for initiate the thermal runaway, then the cell being overcharged can be electrical disconnected.
  - The module shall be considered under test for 24 hours after thermal runaway.
  - Neighbouring modules should be located at the least favourable positions. The test plan shall include justification of why the chosen positions are considered least favourable.
  - Neighbouring modules shall contain live cells in standard configuration; alternatively modules can be configured with dummy cells of similar thermal characteristics, in which case the passing criteria is that a temperature of 85°C is not reached anywhere in the module, as detected at the least favourable locations. The test plan shall include justification of why the chosen positions are considered least favourable.
  - If an extinguishing or coolant media is used to prevent propagation it shall be automatically released. It shall be tested in the same configuration with which it will be installed.
  - Acceptance criteria is defined as only cells within the module which is directly caused to fail by testing show fire or off-gassing and that all cells in neighbour modules show no external signs of thermal runaway and still produce a measurable voltage within normal operating range.

### 2.3 Lithium-ion cell tests

The cells shall be type tested (TT) accordingly to [Table 23.6](#). All the cell tests shall be performed at a recognized laboratory.

**Table 23.6: Type tests of battery cells**

Item	Test	Comments	Test Type
1	external short circuit	IEC 62619 7.2.1	TT
2	impact	IEC 62619 7.2.2	TT
3	thermal abuse	IEC 62619 7.2.4	TT
4	forced discharge	IEC 62619 7.2.6	TT

## 2.4 Lithium-ion battery system tests

The battery system shall be tested in accordance with [Table 23.7](#). The type tests (TT) shall be carried out and witnessed by BKI surveyor at the first certification. The routine tests (RT) shall be performed and witnessed by a BKI surveyor for each product certification.

**Table 23.7: Tests of battery systems**

Item	Test	Comments	Test Type
1	propagation/internal thermal event	IEC 62619 7.3.3 - with amendments given in 4.2.2	TT
2	overcharge with voltage	IEC 62619 8.2.2	TT
3	overcharge with current	IEC 62619 8.2.3	TT
4	overheating control	IEC 62619 8.2.4	TT
5	sensor failures	detection of all failure modes of the sensors	TT
6	cell balancing	according to specification	TT
7	SOC validation	according to specification	TT
8	capacity validation	IEC 62620 6.3.1	TT
9	function and failure response testing	normal operation and failure response of the BMS	TT
10	independent safety function test	emergency disconnection function, independent overcharge protection (not required for cells with CID), HVIL	TT/RT
11	dielectrical strength (high voltage test)	Battery cells that might be damaged by the test can be disconnected to ensure that the test voltage can be applied without damaging the battery cells.	TT/RT
12	insulation resistance	Pt.4 Ch.8 Sec.10 Table 5.	TT/RT
13	cooling failure test	Failures of fans, loss of coolant and leakage detection tested according to specification.	TT
14	pressure test of coolant piping/ hoses	Pt.4 Ch.6 Sec.10 4	TT/RT
15	Visual inspection	Verification of clearances and creepages, short circuit proof installation, possible off-gas ducting etc.	TT

## F. Class Notation SEP (Power)

### 1. General

**1.1** The design shall ensure that any single failure in the SEP system shall not render any main functions unavailable for more than the maximum restoration time specified in [Rules for Machinery Installations \(Pt.1, Vol.III\) Section 1.D](#).

**Note**



Main functions are defined as scope in [Rules for Classification and Surveys \(Pt.1 Vol.I\) Section 2.A.](#)

## 2. Arrangement

2.1 SEP spaces shall be positioned aft of collision bulkhead. Boundaries of SEP spaces shall be part of vessels structure or enclosures with equivalent structural integrity.

2.2 Only equipment associated with the SEP system shall be placed within the SEP space.

2.3 All equipment located at ceiling level in the SEP space shall be suitable for zone 2 installation. The temperature class and gas group for the ex rated zone 2 equipment shall as minimum be T2 and IIC.

2.4 Pipes shall not be installed in the SEP space so that SEP system may be endangered in the event of leaks. If installation of pipes close to the SEP system is unavoidable, the pipes should not have any flanged or screwed connections in this area.

2.5 Fire hydrants shall not be located inside the SEP space.

## 3. Ventilation

### 3.1 General

3.1.1 A mechanical ventilation system is required for the SEP space.

3.1.2 The SEP space ventilation system shall be activated upon off-gas incidents from the SEP system.

#### Note

*It is recommended that the ventilation system is continuously running. See also [Guidance for Ventilation Systems on Board Seagoing Ships \(Pt.1, Vol.A\)](#).*

3.1.3 The ventilation system for SEP spaces shall be an independent ducting system of any other ventilation systems serving other spaces unless the SEP system is designed according to design option 1 as given by [E.1.2.7](#) or designed to ventilate possible off-gas into an integrated off-gas ventilation duct, in which case supply may be taken from ventilation systems serving other spaces and with exhaust directly to open air.

3.1.4 The ventilation ducting system shall be reasonable gas tight and able to withstand the off-gas temperature. For vessels built according to SOLAS Ch.II-2, the pipes to and from the SEP space shall be made of steel.

#### Note

*For vessels built according to other standards than SOLAS Ch. II-2 the pipes to and from the SEP space should be made of steel.*

3.1.5 SEP space ventilators shall be fitted with means of closing whenever:

- the SEP space does not open directly onto an exposed deck
- the ventilation opening for the SEP space is required to be fitted with a closing device according to the Load Line Convention, or
- the SEP space is fitted with a fixed gas fire-extinguishing system.

When a SEP space ventilator is fitted with a closing device, then a warning notice shall be provided at the closing device to mitigate the possibility of inadvertent closing.

#### Note

- *This requirement is based on IMO MSC.1/Circ.1434.*
- *The warning notice could state, for example 'This closing device is to be kept open and only closed in the event of fire or other emergency - Explosive gas'.*

**3.1.6** All ventilation inlet and exhaust evacuated directly to open air shall be to suitable areas to make sure possible toxic gases will not endanger crew or passengers. Areas on open deck within 1.5 m of inlet or exhaust openings of SEP spaces and cabinets are classified as extended hazardous area zone 2.

**3.1.7** Inside the SEP space, the ventilation exhaust suction shall be located 0.4 metre, or closer, to the ceiling. The inlet shall be located as close to the flooring as practical, such that the air is well circulated inside the SEP space.

## 4. System design

### 4.1 General

**4.1.1** The outgoing circuits on a SEP system shall, in addition to short circuit and over current protection, be provided with switchgear for isolating purposes so that isolating for maintenance is possible.

**4.1.2** Electrical insulation to earth of each SEP system shall be monitored and low level shall give alarm.

**4.1.3** Emergency disconnection of the SEP system (as required in [E.1.2.5](#)) shall be arranged at the following locations:

- adjacent to (outside of) the SEP space
- navigation bridge (for Battery(Power) class notation).

**4.1.4** Emergency disconnection shall be arranged as hardwired circuit and separated from components and cables used for control, monitoring and alarm functions.

#### Note

- Requirements in [Section 3](#) are applicable.
- It is accepted that the emergency disconnection is delayed in order to give time for 'soft' shutdown by the control system.

### 4.2 SEP converters

**4.2.1** The converters shall communicate with and operate within the limits given by the battery management system.

**4.2.2** The converters shall be designed with the needed capacity specified by the SEP application.

**4.2.3** The converters shall protect the SEP system against overvoltage and undervoltage. The voltage protection shall be independent of the SEP system, i.e. utilize independent voltage sensors and be independent of the battery management system. The protection levels shall be within the allowable operating values of the SEP system.

#### Note

*Alternatively when the vessel has several SEP converters and/or a SEP converter located on shore then the independent voltage protection could be implemented in the DC switchboard where the SEP system is connected.*

**4.2.4** Charging and discharging failure shall give alarm at a manned control station.

**4.2.5** When an SEP converter is located onshore then the requirements given in [4.2.1](#) and [4.2.3](#) shall be fulfilled.

#### 4.2.6 SEP spaces with SEP system that ventilate possible off-gas directly into the SEP space.

For SEP systems designed to ventilate possible off-gas directly into the SEP space during a failure incident, then:

- An exhaust fan of ex proof non-sparking type shall be provided in the SEP space, delivering under pressure in the SEP space. Fan motors installed within the duct shall be suitable for zone 2 installation.
- The exhaust fan shall be continuously running or start automatically upon detection of off-gas from the SEP system.
- The exhaust fan shall have a capacity:
  - not less than six air changes per hour (ACH), when the SEP system are designed according to design option 1 as given by E.1.2.7.
  - as determined by analysis but not less than six ACH, when the SEP system is designed according to design option 2 given by E.1.2.7.

#### 4.2.7 SEP spaces with SEP system with an integrated off-gas ventilation duct

For SEP systems designed to ventilate possible off-gas into an integrated off-gas ventilation duct, then:

- an inlet fan shall be provided in the SEP space, delivering over-pressure in the SEP space
- The inlet fan in the SEP space shall either be running continuously or start automatically upon detection of off-gas from the SEP system.
- The inlet fan in the SEP space shall have a minimum capacity of six air changes per hour (ACH).
- SEP systems designed according to design option 1 as given by E.1.2.7 are not required to incorporate an off-gas exhaust fan in the duct.
- SEP systems designed according to design option 2 as given by E.1.2.7 shall incorporate an off-gas exhaust fan of ex proof non-sparking type in the duct. Fan motors installed within the duct shall be suitable for zone 2 installation.
- The integrated off-gas duct fan shall be running continuously or start automatically upon detection of off-gas from the SEP system.
- The integrated off-gas ventilation duct inlets shall be provided with non-return valves/flaps where provided.
- The integrated off-gas ventilation shall not be fitted with fire dampers.

**4.2.8** Local start/stop of off-gas ventilation shall be possible upon any failure in the remote or automatic control system without entering the SEP space(s).

**4.2.9** The SEP space ventilation fan(s) shall have power supply from two alternative circuits. One from main source of power and one from the emergency source of power. A change over switch shall be arranged for the two supply circuits.

**4.2.10** The following shall be monitored at a manned control station:

- ambient temperature in SEP space
- indication of ventilation running in the SEP space, and SEP cabinets as applicable.

**4.2.11** The following shall give an alarm at a manned control station:

- high ambient temperature of SEP space
- failure of SEP ventilation and failure of either power supply for SEP ventilator fan.

4.2.12 SEP space temperature alarm and indication shall be independent of the SEP system.

### 4.3 Off-gas detection and monitoring

4.3.1 Gas monitoring shall be arranged in the SEP space. Gas monitoring sensor(s) shall be positioned to provide as early as possible detection.

#### Note

- *The SEP off-gas may be both lighter and heavier than air depending on the temperature of the off-gas, hence two detectors should be used.*
- *A smoke detector may also act as a gas detector.*
- *CO gas detector may be used as an alternative to a purpose-made gas detector.*

4.3.2 Gas detection shall at a level of no more than 30% LEL:

- ensure automatic disconnection of the SEP system
- give alarm at bridge
- be used to start the fan in the SEP space
- failures in the gas detection system shall not lead to disconnection of SEP system.

4.3.3 The gas detection systems shall follow the power supply requirements as given for fire detection systems in Section 9.D.3.

4.3.4 The following shall be monitored and alarmed at a manned control station:

- actual gas concentration in SEP space
- gas level alarm
- failure of the gas detection system.

4.3.5 The gas detection system used for SEP space shall be independent of the SEP system.

## 5. Fire safety for SEP spaces

### 5.1 Fire integrity

5.1.1 An SEP space that contains an SEP system with stored energy of less than 100 kWh shall be defined as:

- areas of moderate fire hazard ('fire category B') on vessel built according to IMO HSC code
- fire category 7 (other machinery space) on a cargo vessel and on a passenger ship carrying not more than 36 passengers built according to SOLAS Ch. II-2
- fire category 11 (other machinery space) on a passenger vessel carrying more than 36 passengers built according to SOLAS Ch. II-2.

An SEP space that contains an SEP system with stored energy of 100 kWh or more shall be defined as:

- areas of major fire hazard ('fire category A') on vessel built according to IMO HSC code
- fire category 6 (machinery space of category A) on a cargo vessel passenger ship carrying not more than 36 passengers built according to SOLAS Ch. II-2
- fire category 12 (machinery space of category A) on a passenger vessel carrying more than 36 passengers built according to SOLAS Ch. II-2.

**5.1.2** For vessels built according to SOLAS Ch. II-2 fire integrity of any SEP spaces (above or below 100kWh) shall in addition to 2.4.1.1 have A-60 fire integrity towards:

- machinery spaces of category A as defined in SOLAS Reg. II-2/3
- enclosed cargo areas for carriage of dangerous goods.

For vessel built according to IMO HSC Code, the note 2 of table 7.4-1 and 7.4-2 shall not be applied (for instance, full structural fire protection is deemed necessary between a machinery space and an SEP space).

**5.1.3** Access to the SEP space shall be through normally closed doors with alarm or self-closing doors.

**5.1.4** For vessels built according to other standards than SOLAS Ch. II-2 and the IMO HSC Code, the fire category and structural fire protection shall provide equivalent protection to the above.

## 5.2 Fire detection

**5.2.1** A fixed fire detection system shall be provided in all SEP spaces. Combined smoke and heat detectors shall be installed. The arrangement shall comply with the international code for fire safety systems (FSS code).

**5.2.2** The components of the fire detection system installed inside the SEP space shall be of a certified safe type for use in explosive atmosphere, see 2.3.

## 5.3 Fire extinguishing

**5.3.1** SEP spaces shall be protected by a fixed fire extinguishing system. Any of the following systems will be accepted:

- water based system according to IMO MSC/Circ.1165, as amended by MSC.1/Circ.1269 and MSC.1/Circ.1386
- a gaseous agent according to FSS Code Ch.5, IMO MSC/Circ.848, as amended by IMO MSC/Circ. 1267 and Pt.1, Vol.Y, FSS Code Ch.5
- a CO<sub>2</sub> system as specified in FSS Code Ch.5 and DNV GL Statutory Interpretations, FSS Code Ch.5.

### Note

*Water based extinguishing system is recommended due to its inherent heat absorbing capabilities.*

### 5.3.2 Water based extinguishing systems

- 1) The water based systems shall be designed to discharge fresh water for 30 minutes operation.
- 2) The system shall be design for switch-over to seawater. At the end of the discharge of freshwater, there shall be an audible and visible alarm on the navigational bridge to notify the crew that fresh-water is no longer available for the fixed fire extinguishing system. Both manual and automatic switch-over arrangements to seawater are permitted.
- 3) The fresh-water specification shall also comply with maker's specification for the water supply (see IMO MSC.1/Circ. 1516 for details).
- 4) The water based system shall be served by dedicated fresh-water tank(s) or from utility service tanks with low-level alarms.

### 5.3.3 Gas based extinguish systems

- 1) For the gaseous agent or CO<sub>2</sub> the design concentration shall be suitable for applicable flammable gases.
- 2) Gaseous agents or CO<sub>2</sub> systems protecting a space that contains a SEP system with stored energy of 100 kWh, or more, shall be provided with a second, independent charge with same capacity as the first charge (a 2 x 100 % system).
- 3) For halocarbon clean agents (chemical gaseous agents required to discharge 95 % within 10 seconds) the following shall be documented:
  - Pressure peaks and under-pressures expected during release of the extinguishing gas.
  - Structural integrity of doors and ventilation dampers in the boundary of the space when exposed to these pressure peaks and under-pressures. Doors and dampers shall remain intact after exposure.

**5.3.4** For SEP systems designed according to option 2 as given by [E.1.2.7](#) with an 'integrated' extinguishing agent for thermal propagation prevention, that extinguishing system shall be provided in addition to the fixed fire extinguishing system required by [F.5.3.1](#). The thermal propagation prevention extinguishing agent required shall be designed to release automatically.

#### Note

- *The extinguishing agent used for thermal propagation prevention can be the same system as the fixed fire extinguishing system as required by [F.5.3.1](#) if redundant capacity is ensured, i.e. minimum two separate releases.*
- *Automatic release of gas extinguishing agents shall be approved by the flag administration on a case-by-case basis.*

## 6. Safety philosophy of the onboard installation

**6.1** The arrangement of the SEP spaces shall be such that the safety of passengers, crew and vessel is ensured. The safety philosophy for the SEP space shall be documented. The safety philosophy should cover all potential hazards represented by the type of SEP system and cover at least:

- gas development hazard (toxic, flammable, corrosive)
- fire hazard
- explosion hazard
- necessary detection, monitoring and alarm systems (off-gas detection, fire detection etc.) and ventilation
- ventilation handling in case of off-gas release and/or fire
- external hazards (fire, water ingress, etc.).

**6.2** The safety philosophy shall be based on the actual vessel and SEP system to be used. The safety description for the SEP system, as required in [E.1.2.1](#), shall be used as basis.

## 7. Testing

After installation, the following tests shall be performed:

- test of correct interface between the SEP converters and the SEP system
- test of SEP converter's independent SEP voltage protection functions
- test of the SEP system and its auxiliaries, including alarms, emergency disconnection and safety functions
- test of functions in the SEP space (e.g. ventilation, liquid cooling, gas detection, fire detection, leakage detection) as installed.

### Note

Requirements for testing of the electrical installation is given in [Section 21](#) and [Guidance for The Approval and Type Approval of Materials and Equipment for Marine Use \(Pt.1, Vol.W\) Sec. 3.T](#). Requirements for testing of the control systems is given in [Guidance for The Approval and Type Approval of Materials and Equipment for Marine Use \(Pt.1, Vol.W\) Sec. 3.V](#).

## 8. Operation and maintenance

### 8.1 Operation

Instructions for emergency operation shall be kept on board.

The emergency operation procedures shall include actions for handling the SEP systems and ventilation in case of an external fire and the event of an internal thermal incident.

### Note

*Additional equipment (e.g. CCTV) giving situational awareness to crew may be beneficial.*

### 8.2 Maintenance

A plan for systematic maintenance and function testing shall be kept on board showing in detail how components and systems shall be tested and what shall be observed during the tests.

## G. Class notation SEP(Propulsion)

### 1. General

The following requirements are to be applied for SEP(Propulsion) notation. In addition, the requirements in F for SEP(Power) shall be fulfilled.

### 2. System design

#### 2.1 Battery system

**2.1.1** Where the entire main power source is supplied by battery only, the main power sources shall consist of at least two independent SEP systems located in two separate SEP spaces.

**2.1.2** The cables from the SEP system to the main switchboard shall follow the routing requirements as given in [Section 12.D](#).

**2.1.3** An SEP system shall be able to supply the short circuit current necessary to obtain selective tripping of downstream circuit breakers and fuses.

**2.1.4** It shall be possible to operate the SEP system locally. This local operation shall be independent from any remote control (e.g. PMS, IAS) systems.

**Note**

*The local operation workstation can be located at the SEP system, the switchboard room or at the SEP converter. Local operation is understood as being able to connect the SEP system to the switchboard. The requirement for local operation applies only for vessels where the SEP is necessary in order to maintain propulsion, i.e. this does not apply to hybrid solutions where the main class propulsion requirement is fulfilled by diesel or gas fuelled propulsion engine(s) or generator(s).*

## 2.2 Battery capacity

**2.2.1** When an SEP system replaces one of the required main sources of power in [Section 3.B](#), the capacity of the SEP system shall be sufficient for the intended operation of the vessel. This applies both to normal operation and after a worst case failure.

Minimum remaining propulsion power after worst case failure ( $P_{prop-wcf}$ ) shall be calculated based on remaining power for the propulsion motors after the worst case single failure have occurred, e.g. loss of a main switchboard or loss of a main power source. Minimum remaining propulsion power after worst case failure ( $P_{prop-wcf}$ ) shall be documented in the electrical load balance.

**Note**

- In addition to  $P_{prop-wcf}$ , the vessels dependency of the SEP will be stated in the appendix to the class certificate as an operational limitation.
- Where the SEP system form a part of the dynamic positioning (DP) system, worst case failure is based on relevant requirements and failure modes for the applicable DP notation.

**2.2.2** When SEP systems are used as redundant power sources for dynamic positioning, the capacity of the SEP systems (available power and available energy) shall be sufficient for the planned operation. See [Rules for Dynamic Positioning System \(Pt.4, Vol.II\)](#).

**2.2.3** The SOC and SOH of the SEP systems shall be monitored and available for the operator.

**2.2.4** In case of over-temperature in a SEP system, a request for manual load reduction shall be issued both visually and acoustically on the bridge. Alternatively an automatic load reduction can be arranged.

**2.2.5** Monitoring of SEP systems supplying propulsion power for dynamic positioning systems, shall follow requirements as given in [Rules for Dynamic Positioning System \(Pt.4, Vol.II\)](#) as applicable.

## 2.3 Energy management system

**2.3.1** Energy management system (EMS) shall be installed.

**Note**

*The EMS functions may be integrated in the vessel's automation system, the power management system or DP control system.*

**2.3.2** For SEP systems providing power to main and/or redundant propulsion or dynamic positioning, the energy management system shall provide a reliable measure of the available energy and power, taking into consideration the SEP systems SOH and SOC.

**Note**

*The calculation of available energy and power should take into account the possible inaccuracy of the SOC and SOH given by the SEP system.*



2.3.3 For a vessel depending on the stored energy in the SEP for seagoing operation, the following shall be calculated:

- 1) Remaining time for seagoing operation ( $T_{op}$ )

**Note**

*The calculation of remaining time for seagoing operation,  $T_{op}$ , should be based on the available energy and the average power consumption for relevant period.*

$$T_{op} = \frac{AE}{P_{avr}}$$

where:

$T_{op}$  = remaining time for seagoing operation (h)

AE = available energy (kWh)

$P_{avr}$  = average power consumption for relevant period (kW).

- 2) Remaining time for seagoing operation after worst case single failure ( $T_{wcf}$ ). Only applicable for vessels depending on the energy stored in SEP for propulsion after worst case failure.
- 3) Remaining time for powering emergency consumers ( $T_{em}$ ). Only applicable for vessels depending on the energy stored in the SEP for supplying emergency consumers.

2.3.4 The following parameters shall be provided with remote monitoring at the navigating bridge:

- available energy (AE) of the SEP systems
- available power (AP) of the SEP systems
- remaining time for seagoing operation ( $T_{op}$ )
- remaining time for seagoing operation after worst case failure ( $T_{wcf}$ ) if the vessel is depending on the energy stored in the SEP for propulsion after worst case failure
- remaining time for powering emergency consumers ( $T_{em}$ ) if the vessel is depending on the energy

2.3.5 The following warning and alarm shall be provided the navigating bridge:

- If the vessel is depending on the energy stored in the SEP for propulsion after worst case failure then an individual warning shall be given at the navigating bridge when the SEP system reaches minimum capacity as required for the intended operation or voyage. This warning shall be based on the remaining time for seagoing operation after worst case single failure ( $T_{wcf}$ ). The warning level will be operator set accordingly to the vessels operation(s).
- If the vessel is depending on the energy stored in the SEP for supplying emergency consumers then an individual alarm shall be given at the navigating bridge when the SEP system reaches minimum capacity as required for powering the emergency consumers.

### 3. Testing

Supplementary to the tests stated in F.7, the following shall be verified by testing:

- verify that the SEP capacity (SOH) is consistent with the SOH value calculated for all the SEP systems. If there is a larger deviation than +/- 5%, then the values in the SEP system shall be adjusted
- charging and discharging capacities to verify maximum C-rates as specified for the intended operation of the vessel.

#### 4. Operation and maintenance

##### 4.1 Operation

Operating instruction shall be kept on board and shall include the following in addition to the emergency procedures stated in [F.8.1](#):

- charging procedure
- normal operation procedures of the SEP system
- local operation procedure
- conditions and procedures to prepare the SEP system for extended period of standby.

##### 4.2 Maintenance

A maintenance plan for the SEP system shall be kept on board and shall include verification procedures for SOH in addition to the elements stated in [F.8.2](#).

## Section 24 Cyber Resilience of Ships

A.	Introduction . . . . .	24-1
B.	Definitions . . . . .	24-4
C.	Goals and organization of requirements . . . . .	24-6
D.	Requirements . . . . .	24-7
E.	<b>Demonstration of compliance</b> . . . . .	24-36
F.	Risk assessment for exclusion of CBS from the application of requirements . . . . .	24-39
G.	Summary of actions and documents . . . . .	24-41
H.	Summary of requirements and documents . . . . .	24-42

### A. Introduction

Interconnection of computer systems on ships, together with the widespread use onboard of commercial-off-the-shelf (COTS) products, open the possibility for attacks to affect personnel data, human safety, the safety of the ship, and threaten the marine environment.

Attackers may target any combination of people and technology to achieve their aim, wherever there is a network connection or any other interface between onboard systems and the external world. Safeguarding ships, and shipping in general, from current and emerging threats involves a range of measures that are continually evolving.

It is then necessary to establish a common set of minimum functional and performance criteria to deliver a ship that can indeed be described as cyber resilient.

BKI considers that minimum requirements applied consistently to the full threat surface using a goal-based approach is necessary to make cyber resilient ships.

#### 1. Structure of this Section

**Table 24.1: Structure of the Section**

Introductory Part	A. Introduction
	B. Definitions
	C. Goals and Organization of Requirements
Main Part	D. Requirements <ol style="list-style-type: none"> <li>1. Identify</li> <li>2. Protect</li> <li>3. Detect</li> <li>4. Respond</li> <li>5. Recover</li> </ol>
	E. Test plan for performance evaluation and testing <ol style="list-style-type: none"> <li>1. During design and construction phases</li> <li>2. Upon ship commissioning</li> <li>3. During the operational life of the ship</li> </ol>
	F. Risk assessment for exclusion of CBS from the application of requirements (required only when systems are excluded from application of this Section)
	G. Summary of Actions and Documents
	H. <b>Summary of requirements and documents</b>
Supplementary Part	

## 2. Aim and purpose

The aim of this Section is to provide a minimum set of requirements for cyber resilience of ships, with the purpose of providing technical means to stakeholders which would lead to cyber resilient ships.

This Section targets the ship as a collective entity for cyber resilience and is intended as a base for the complementary application of other Rules or Guidelines and industry standards addressing cyber resilience of onboard systems, equipment and components.

Minimum requirements for cyber resilience of on-board systems and equipment are given in [Section 25](#).

As long as on-board systems and equipment are part of a computer-based systems in the scope of applicability of this Section and are not considered as individual entities, for such systems and equipment more stringent requirements than those enforced in [Section 25](#) may be required as per [Section 25](#) additional system requirements to support the fulfilment of this Section. Requirements in Guidelines for Maritime Cybersecurity may additionally be applied.

## 3. Scope of applicability

### 3.1 Vessels in scope

This Section is applicable to the following vessels:

- Passenger ships (including passenger high-speed craft) engaged in international voyages
- Cargo ships of 500 GT and upwards engaged in international voyages
- High speed craft of 500 GT and upwards engaged in international voyages
- Mobile offshore drilling units of 500 GT and upwards
- Self-propelled mobile offshore units engaged in construction (i.e. wind turbine installation maintenance and repair, crane units, drilling tenders, accommodation, etc)

This Section may be used as non-mandatory guidance to the following.

- Ships of war and troopships
- Cargo ships less than 500 GT
- Vessels not propelled by mechanical means
- Wooden ships of primitive build
- Passenger yachts (passengers not more than 12)
- Pleasure yachts not engaged in trade
- Fishing vessels
- Site specific offshore installations (i.e. FPSOs, FSUs, etc.)

### 3.2 Systems in scope

This Section applies to:

- 1) Operational Technology (OT) systems onboard ships, i.e. those computer-based systems (CBS) using data to control or monitor physical processes that can be vulnerable to cyber incidents and, if compromised, could lead to dangerous situations for human safety, safety of the vessel and/or threat to the environment.

In particular, the CBSs used for the operation of the following ship functions and systems, if present onboard, shall be considered:

- Propulsion
- Steering
- Anchoring and mooring
- Electrical power generation and distribution
- Fire detection and extinguishing systems
- Cargo handling system (limited to safety-related elements)
- Bilge and ballast systems, loading/unloading control systems, loading computer
- Boiler control system
- Scrubber control system and other systems needed for compliance with class or international regulations to prevent pollution to the environment
- Watertight integrity and flooding detection
- Lighting (e.g. emergency lighting, low locations, navigation lights, etc.)
- Any other OT system whose disruption or functional impairing may pose risks to ship operations (e.g. LNG monitoring and control system, relevant gas detection system etc.)

In addition, the following systems shall be included in the scope of applicability of this Section:

- Navigational systems required by statutory regulations
- Internal and external communication systems required by class rules and statutory regulations

For navigation and radiocommunication systems, the application of IEC 61162-460 or other equivalent standards in lieu of the required security capabilities in [Section 25.D](#) may be accepted by BKI, on the condition that requirements in this Section are complied with.

- 2) Any Internet Protocol (IP)-based communication interface from CBSs in scope of this Section to other systems. Examples of such systems are, but not limited to, the following:
- passenger or visitor servicing and management systems,
  - passenger-facing networks
  - administrative networks
  - crew welfare systems
  - any other systems connected to OT systems, either permanently or temporarily (e.g. during maintenance).

The cyber incidents considered in this Section are events resulting from any offensive manoeuvre that targets OT systems onboard ships as defined in [B](#).

### 3.3 System Category

System categories are defined in [Section 10](#) on the basis of the consequences of a system failure to human safety, safety of the vessel and/or threat to the environment.

### 3.4 References to Other Requirement on Computer Based Systems and Cyber Resilience

Attention is made to additional Rules and Guidelines on Computer Based Systems and Cyber Resilience as follows:

- [Section 10](#) of this Rules includes requirements for design, construction, commissioning and maintenance of computer-based systems where they depend on software for the proper achievement of their functions. The requirements in [Section 10](#) focus on the functionality of the software and on the hardware supporting the software which provide control, alarm, monitoring, safety or internal communication functions subject to classification requirements.

- [Section 25](#) of this Rules includes requirements for cyber resilience for on-board systems and equipment.
- [Guidance for Marine Industry \(Pt.1, Vol. AC\) Sec 9.R.166](#) : non-mandatory recommended technical requirements that stakeholders may reference and apply to assist with the delivery of cyber resilient ships, whose resilience can be maintained throughout their service life. [Guidance for Marine Industry \(Pt.1, Vol. AC\) Sec 9.R.166](#) is intended for ships contracted for construction after its publication and may be used as a reference for ships already in service prior to its publication. For ships to which this section applies as mandatory instrument, when both this section and [Guidance for Marine Industry \(Pt.1, Vol. AC\) Sec 9.R.166](#) are used, should any difference in requirements addressing the same topic be found between the two instruments, the requirements in this section shall prevail.

## B. Definitions

In the purview of this Section, the following definitions apply:

**Annual Survey:** See [Rules for Classification and Survey \(Pt.1, Vol.I\)](#)

**Attack Surface:** The set of all possible points where an unauthorized user can access a system and extract data. The attack surface comprises two categories: digital and physical. The digital attack surface encompasses all the hardware and software that connect to an organization's network. These include applications, code, ports, servers and websites. The physical attack surface comprises all endpoint devices that an attacker can gain physical access to, such as desktop computers, hard drives, laptops, mobile phones, removable drives and carelessly discarded hardware.

**Authentication:** Provision of assurance that a claimed characteristic of an entity is correct.

**Compensating countermeasure:** An alternate solution to a countermeasure employed in lieu of or in addition to inherent security capabilities to satisfy one or more security requirements.

**Computer Based System (CBS):** A programmable electronic device, or interoperable set of programmable electronic devices, organized to achieve one or more specified purposes such as collection, processing, maintenance, use, sharing, dissemination, or disposition of information. CBSs onboard include IT and OT systems. A CBS may be a combination of subsystems connected via network. Onboard CBSs may be connected directly or via public means of communications (e.g. Internet) to ashore CBSs, other vessels' CBSs and/or other facilities.

**Computer Network:** A connection between two or more computers for the purpose of communicating data electronically by means of agreed communication protocols.

**Cyber incident:** An event resulting from any offensive manoeuvre, either intentional or unintentional, that targets or affects one or more CBS onboard, which actually or potentially results in adverse consequences to an onboard system, network and computer or the information that they process, store or transmit, and which may require a response action to mitigate the consequences. Cyber incidents include unauthorized access, misuse, modification, destruction or improper disclosure of the information generated, archived or used in onboard CBS or transported in the networks connecting such systems. Cyber incidents do not include system failures.

**Cyber resilience:** The capability to reduce the occurrence and mitigating the effects of cyber incidents arising from the disruption or impairment of operational technology (OT) used for the safe operation of a ship, which potentially lead to dangerous situations for human safety, safety of the vessel and/or threat to the environment.

**Defence in depth:** Information Security strategy integrating people, technology, and operations capabilities to establish variable barriers across multiple layers and missions of the organization.

**Demilitarized zone (DMZ):** A physical or logical perimeter network segment that contains and exposes an organization's external-facing services to an external network. Its purpose is to enforce the internal network's security policy for external information exchange and to provide external, untrusted sources with restricted access to releasable information while shielding the internal networks from outside attacks.

**Essential System:** Computer Based System contributing to the provision of services essential for propulsion and steering, and safety of the ship. Essential services comprise "Primary Essential Services" and "Secondary Essential Services": Primary Essential Services are those services which need to be in continuous operation to maintain propulsion and steering; Secondary Essential Services are those services which need not necessarily be in continuous operation to maintain propulsion and steering but which are necessary for maintaining the vessel's safety.

**Information Technology (IT):** Devices, software and associated networking focusing on the use of data as information, as opposed to Operational Technology (OT).

**Initial Authenticator Content:** Factory default authentication credentials (e.g.: initial passwords, tokens, etc.) to allow for initial installation and configuration of system.

**Integrated system:** A system combining a number of interacting sub-systems and/or equipment organized to achieve one or more specified purposes.

**Logical network segment:** The same as "Network segment", but two or more logical network segments share the same physical components.

**Note on TCP/IP:** Logical networks are hosted on the same physical network but segmented and managed at the data link or network layers (OSI Layer 2 and 3).

**Network:** A connection between two or more computers for the purpose of communicating data electronically by means of agreed communication protocols.

**Network segment:** A collection of nodes that share the same network address plan. A network segment is a broadcast domain.

**Note on TCP/IP:** Network address plan is prefixed by their IP addresses and the network mask. Communication between network segments is only possible by the use of routing service at network layer (OSI Layer 3).

**Operational Technology (OT):** Devices, sensors, software and associated networking that monitor and control onboard systems. Operational technology systems may be thought of as focusing on the use of data to control or monitor physical processes.

**Physical network segment:** The same as "Network segment". The physical components are not shared by other network segments.

**Note on TCP/IP:** Segmentation breaks networks down into multiple physical segments or subnets. The incoming and outgoing packets are controlled. The connections and data exchanges are allowed or blocked at both network layer (OSI Layer 3) and application level (OSI Layer 7). Both traffic management and packet filtering can be managed by a single software or hardware equipment.

**Protocol:** A common set of rules and signals that computers on the network use to communicate. Protocols allow to perform data communication, network management and security. Onboard networks usually implement protocols based on TCP/IP stacks or various field buses.

**Security zone:** A collection of connected CBSs in the scope of applicability of this Section that require the same access control policy. Each zone consists of a single interface or a group of interfaces, to which an access control policy is applied.

**Ship Designer/Shipyard:** The person or organization:

- implementing the process of evolving the ship specifications given by the Shipowner into a complete ship project, including management of concept, contract and detail design, and/or
- in charge of ship construction and responsible for fulfilling during ship construction the requirements of applicable rules and regulations and implementing the specifications of ship design, and/or
- responsible for the integration of systems and products provided by Suppliers into an integrated system.

**Shipowner/Company:** The owner of the ship or any other organization or person, such as the manager, agent or bareboat charterer, who has assumed the responsibility for operation of the ship from the shipowner and who on assuming such responsibilities has agreed to take over all the attendant duties and responsibilities. The Owner could be the Shipyard or System Integrator (Builder or Shipyard) during initial construction. After vessel delivery, the owner may delegate some responsibilities to the vessel management company.

**Special survey:** [Rules for Classification and Survey \(Pt.1, Vol.I\)](#)

**Supplier:** A manufacturer or provider of hardware and/or software products, system components or equipment (hardware or software) comprising of the application, embedded devices, network devices, host devices etc. working together as system or a subsystem. The Supplier is responsible for providing programmable devices, sub-systems or systems to the System Integrator.

**System Integrator:** The specific person or organization responsible for the integration of systems and products provided by Suppliers into the system invoked by the requirements in the ship specifications and for providing the integrated system. The system integrator may also be responsible for integration of systems in the ship. This role shall be taken by the Shipyard unless an alternative organization is specifically contracted/assigned this responsibility.

**Untrusted network:** Any network outside the scope of applicability of this Section.

**Virtual Private Network (VPN):** A virtual network, built on top of existing physical networks, that provides a secure communications tunnel for data transmitted between networks or devices utilizing tunnelling, security controls and endpoint address translation giving the impression of a dedicated line.

## C. Goals and organization of requirements

### 1. Primary goal

The primary goal is to support safe and secure shipping, which is operationally resilient to cyber risks.

Safe and secure shipping can be achieved through effective cyber risk management system. To support safe and secure shipping resilient to cyber risk, the following sub-goals for the management of cyber risk are defined in the five functional elements listed in 2 below.

### 2. Sub-goals per functional element

- 1) Identify: Develop an organizational understanding to manage cybersecurity risk to onboard systems, people, assets, data, and capabilities.
- 2) Protect: Develop and implement appropriate safeguards to protect the ship against cyber incidents and maximize continuity of shipping operations.
- 3) Detect: Develop and implement appropriate measures to detect and identify the occurrence of a cyber incident onboard.
- 4) Respond: Develop and implement appropriate measures and activities to take action regarding a detected cyber incident onboard.
- 5) Recover: Develop and implement appropriate measures and activities to restore any capabilities or services necessary for shipping operations that were impaired due to a cyber incident.

These sub-goals and relevant functional elements should be concurrent and considered as parts of a single comprehensive risk management framework.



### 3. Organization of requirements

The requirements are organized according to a goal-based approach. Functional/technical requirements are given for the achievement of specific sub-goals of each functional element. The requirements are intended to allow a uniform implementation by stakeholders and to make them applicable to all types of vessels, in such a way as to enable an acceptable level of resilience and apply to all classed vessels/units regardless of operational risks and complexity of OT systems.

For each requirement, a rationale is given.

A summary of actions to be carried out and documentation to be made available is also given for each phase of the ship's life and relevant stakeholders participating to such phase.

Criteria for performance evaluation and testing are also given.

## D. Requirements

This section contains the requirements to be satisfied in order to achieve the primary goal defined in C.1, organized according to the five functional elements identified in C.2.

The requirements shall be fulfilled under the responsibility of stakeholders involved in the design, building and operation of the ship. Among them, the following stakeholders can be identified (see also B for definitions):

- Shipowner/Company
- System Integrator
- Supplier
- Classification Society

Whilst the above requirements may be fulfilled by these stakeholders, for the purposes of this Section, responsibility to fulfil them will lie with the stakeholder who has contracted with BKI.

### 1. Identify

The requirements for the 'Identify' functional element are aimed at identifying: on one side, the CBSs onboard, their interdependencies and the relevant information flows; on the other side, the key resources involved in their management, operation and governance, their roles and responsibilities.

#### 1.1 Vessel asset inventory

##### 1.1.1 Requirement

An inventory of hardware and software (including application programs, operating systems, if any, firmware and other software components) of the CBSs in the scope of applicability of this Section and of the networks connecting such systems to each other and to other CBSs onboard or ashore shall be provided and kept up to date during the entire life of the ship.

##### 1.1.2 Rationale

The inventory of CBSs onboard and relevant software used in OT systems, is essential for an effective management of cyber resilience of the ship, the main reason being that every CBS becomes a potential point of vulnerability. Cybercriminals can exploit unaccounted and out-of-date hardware and software to hack systems. Moreover, managing CBS assets enables Companies understand the criticality of each system to ship safety objectives.

### 1.1.3 Requirement details

The vessel asset inventory shall include at least the CBSs indicated in [A.3.2](#), if present onboard.

The inventory shall be updated during the entire life of the ship. Software and hardware modifications potentially introducing new vulnerabilities or modifying functional dependencies or connections among systems shall be recorded in the inventory.

If confidential information is included in the inventory (e.g. IP addresses, protocols, port numbers), special measures shall be adopted to limit the access to such information only to authorized people.

#### 1.1.3.1 Hardware

For all hardware devices in the scope of applicability of this Section, the vessel asset inventory shall include at least the information in [Section 25.C.1.1](#).

In addition, the vessel asset inventory may specify system category and security zone associated with the CBS.

#### 1.1.3.2 Software

For all software in the scope of applicability of this Section (e.g., application program, operating system, firmware), the vessel asset inventory shall include at least the information in [Section C.1.1](#).

The software of the CBSs in the scope of applicability of this Section shall be maintained and updated in accordance with the shipowner's process for management of software maintenance and update policy in the Ship cyber security and resilience program, see [E.3.1](#)

### 1.1.4 Demonstration of compliance

#### 1.1.4.1 Design phase

The systems integrator shall submit vessel asset inventory to BKI (ref. [E.1.3](#)).

The vessel asset inventory shall incorporate the asset inventories of all individual CBSs falling under the scope of this Section. Any equipment in the scope of this Section delivered by the systems integrator shall also be included in the vessel asset inventory.

#### 1.1.4.2 Construction phase

The systems integrator shall keep the vessel asset inventory updated.

#### 1.1.4.3 Commissioning phase

The systems integrator shall submit Ship cyber resilience test procedure (ref. [E.2.1](#)) and demonstrate to BKI that:

- Vessel asset inventory is updated and completed at delivery
- CBSs in the scope of applicability of this Section are correctly represented by the vessel asset inventory
- Software of the CBSs in the scope of applicability of this Section has been kept updated, e.g. by vulnerability scanning or by checking the software versions of CBSs while switched on.

#### 1.1.4.4 Operation phase

For general requirements to surveys in the operation phase, see [E.3](#). The shipowner shall in the Ship cyber security and resilience program describe the process of management of change (MoC) for the CBSs in the scope of applicability of this Section, addressing at least the following requirements in this Section:

- Management of change ([E.3](#))
- Hardware and software modifications ([D.1.1.3](#))

The shipowner shall in the Ship cyber security and resilience program also describe the management of software updates, addressing at least the following requirements in this Section:

- Vulnerabilities and cyber risks ([D.1.1.2](#) and [D.1.1.3](#))
- Security patching ([D.2.6.3.2](#))

#### First annual survey

The shipowner shall present to BKI records or other documented evidence demonstrating implementation of the Ship cyber security and resilience program, i.e., that:

- The approved management of change process has been adhered to.
- Known vulnerabilities and functional dependencies have been considered for the software in the CBSs.
- The Vessel asset inventory has been kept updated.

#### Subsequent annual surveys

The shipowner shall upon request by BKI demonstrate implementation of the Ship cyber security and resilience program by presenting records or other documented evidence as specified for the first annual survey.

#### Special Survey

The shipowner shall demonstrate to BKI the activities in [D.1.1.4.3](#) as per the Ship cyber resilience test procedure.

## 2. Protect

The requirements for the Protect functional element are aimed at the development and implementation of appropriate safeguards supporting the ability to limit or contain the impact of a potential incident

### 2.1 Security Zones and Network Segmentation

#### 2.1.1 Requirement

All CBSs in the scope of applicability of this Section shall be grouped into security zones with well-defined security control policy and security capabilities. Security zones shall either be isolated (i.e. air gapped) or connected to other security zones or networks by means providing control of data communicated between the zones (e.g. firewalls/routers, simplex serial links, TCP/IP diodes, dry contacts, etc.)

Only explicitly allowed traffic shall traverse a security zone boundary.

### 2.1.2 Rationale

While networks may be protected by firewall perimeter and include Intrusion Detection Systems (IDS) or Intrusion Prevention Systems (IPS) to monitor traffic coming in, breaching that perimeter is always possible. Network segmentation makes it more difficult for an attacker to perpetrate an attack throughout the entire network.

The main benefits of security zones and network segmentation are to reduce the extent of the attack surface, prevent attackers from achieving lateral movement through systems, and improve network performance. The concept of allocating the CBSs into security zones allows grouping the CBSs in accordance with their risk profile.

### 2.1.3 Requirement details

A security zone may contain multiple CBSs and networks, all of which shall comply with the security requirements given in this Section and 25.

The network(s) of a security zone shall be logically or physically segmented from other zones or networks. See also D.2.6.3.

CBSs providing required safety systems shall be grouped into separate security zones and shall be physically segmented from other security zones.

Navigational and communication systems shall not be in same security zone as machinery or cargo systems. **If navigation and/or radiocommunication systems are approved in accordance with other equivalent standard(s) (see A.3.2), these systems should be in a dedicated security zone.**

Wireless devices shall be in dedicated security zones. See also D.2.5.

Other OT-systems or CBSs outside the scope of applicability of this Section shall be physically segmented from security zones required by this Section. Alternatively, it is accepted that other OT-systems are part of a security zone if these OT-systems meet the same requirements as demanded by the zone.

It shall be possible to manually isolate a security zone without affecting the primary functionality of the CBSs in the zone.

In the definition of security control policies, the functions allowed to access or operate on the network shall be associated to technical procedures and roles.

### 2.1.4 Demonstration of compliance

#### 2.1.4.1 Design phase

The systems integrator shall submit Zones and conduit diagram and the Cyber security design description (see E.1.1 and E.1.2).

The Zones and conduit diagram shall illustrate the CBSs in the scope of applicability of this Section, how they are grouped into security zones, and include the following information:

- Clear indication of the security zones
- Simplified illustration of each CBS in scope of applicability of this Section, and indication of the security zone in which the CBS is allocated, and indication of physical location of the CBS/equipment.
- Reference to the approved version of the CBS system topology diagrams provided by the suppliers (Section 25C.1.2)
- Illustration of network communication between systems in a security zone
- Illustration of any network communication between systems in different security zones (conduits).

- Illustration of any communication between systems in a security zone and untrusted networks (conduits).

The systems integrator shall include the following information in the Cyber security design description:

- A short description of the CBSs allocated to the security zone. It shall be possible to identify each CBS in the Zones and conduit diagram.
- Network communication between CBSs in the same security zone. The description shall include purpose and characteristics (i.e. protocols and data flows) of the communication.
- Network communication between CBSs in different security zones. The description shall include purpose and characteristics (i.e. protocols and data flows) of the communication. The description shall also include zone boundary devices and specify the traffic that is permitted to traverse the zone boundary (e.g. firewall rules).
- Any communication between CBSs in security zones and untrusted networks. The description shall include discrete signals, serial communication, and the purpose and characteristics (i.e. protocols and data flows) of IP-based network communication. The description shall also include zone boundary devices and specify the traffic that is permitted to traverse the zone boundary (e.g. firewall rules).

#### 2.1.4.2 Construction phase

The systems integrator shall keep the Zones and conduit diagram updated.

#### 2.1.4.3 Commissioning phase

The systems integrator shall submit Ship cyber resilience test procedure (ref. [E.2.1](#)) and demonstrate to BKI that:

- the security zones on board are implemented in accordance with the approved documents (i.e. zones and conduit diagram, cyber security design description, asset inventory, and relevant documents provided by the supplier). This may be done by e.g., inspection of the physical installation, network scanning and/or other methods providing the Surveyor assurance that the installed equipment is grouped in security zones according to the approved design.
- security zone boundaries allow only the traffic that has been documented in the approved Cyber security description. This may be done by e.g., evaluation of firewall rules or port scanning.

#### 2.1.4.4 Operation phase

For general requirements to surveys in the operation phase, see [E.3.](#)

The shipowner shall in the Ship cyber security and resilience program describe the management of security zone boundary devices (e.g., firewalls), addressing at least the following requirements in this Section:

- Principle of Least Functionality ([D.2.2.1](#))
- Explicitly allowed traffic ([D.2.1.1](#))
- Protection against denial of service (DoS) events ([D.2.2.1](#))
- Inspection of security audit records ([D.3.1.3](#))

#### First annual survey

The shipowner shall demonstrate to BKI that the Zones and conduit diagram has been kept updated and present records or other documented evidence demonstrating implementation of the Ship cyber security

and resilience program, i.e., that security zone boundaries are managed in accordance with the above requirements.

### Subsequent annual surveys

The shipowner shall upon request by BKI demonstrate implementation of the Ship cyber security and resilience program by presenting records or other documented evidence as specified for the first annual survey.

### Special survey

The shipowner shall demonstrate to BKI the activities in 2.1.4.3 as per the Ship cyber resilience test procedure.

## 2.2 Network protection safeguards

### 2.2.1 Requirement

**Security zones** shall be protected by firewalls or equivalent means as specified in D.2.1.

The networks shall also be protected against the occurrence of excessive data flow rate and other events which could impair the quality of service of network resources.

The CBSs in scope of this Section shall be implemented in accordance with the principle of Least Functionality, i.e. configured to provide only essential capabilities and to prohibit or restrict the use of non-essential functions, where unnecessary functions, ports, protocols and services are disabled or otherwise prohibited.

### 2.2.2 Rationale

Network protection covers a multitude of technologies, rules and configurations designed to protect the integrity, confidentiality and availability of computer networks. The threat environment is always changing, and attackers are always trying to find and exploit vulnerabilities.

There are many layers to consider when addressing network protection. Attacks can happen at any layer in the network layers model, so network hardware, software and policies must be designed to address each area.

While physical and technical security controls are designed to prevent unauthorized personnel from gaining physical access to network components and protect data stored on or in transit across the network, procedural security controls consist of security policies and processes that control user behaviour.

### 2.2.3 Requirement details

The design of network shall include means for limiting data flow rate to meet the intended data flow through the network and minimize the risk of denial of service (DoS) and network storm/high rate of traffic. Estimation of data flow rate shall at least consider the capacity of network, data speed requirement for intended application and data format.

### 2.2.4 Demonstration of compliance

#### 2.2.4.1 Design phase

No requirements.

#### 2.2.4.2 Construction phase

No requirements.

### 2.2.4.3 Commissioning phase

The systems integrator shall submit Ship cyber resilience test procedure (ref. [E.2.1](#)) and demonstrate the following to BKI:

- Test denial of service (DoS) attacks targeting zone boundary protection devices, as applicable.
- Test denial of service (DoS) to ensure protection against excessive data flow rate, originating from inside each network segment. Such denial of service (DoS) tests shall cover flooding of network (i.e., attempt to consume the available capacity on the network segment), and application layer attack (i.e., attempt to consume the processing capacity of selected endpoints in the network)
- Test e.g. by analytic evaluation and port scanning that unnecessary functions, ports, protocols and services in the CBSs have been removed or prohibited in accordance with hardening guidelines provided by the suppliers. See Section [E.7.](#) and [F.3.4.7.](#)

The second and third tests may be omitted if performed during the certification of CBSs asper [E.2.1](#).

### 2.2.4.4 Operation phase

For general requirements to surveys in the operation phase, see [E.3.](#)

#### Special survey

Subject to modifications of the CBSs, the shipowner shall demonstrate to BKI the activities in [2.2.4.3](#) as per the Ship cyber resilience test procedure.

## 2.3 Antivirus, antimalware, antispam and other protections from malicious code

### 2.3.1 Requirement

CBSs in the scope of applicability of this Section shall be protected against malicious code such as viruses, worms, trojan horses, spyware, etc.

### 2.3.2 Rationale

A virus or any unwanted program that enters a user's system without his/her knowledge can self-replicate and spread, perform unwanted and malicious actions that end up affecting the system's performance, user's data/files, and/or circumvent data security measures.

Antivirus, antimalware, antispam software will act as a closed door with a security guard fending off all the malicious intruding viruses performing a prophylactic function. It detects any potential virus and then works to remove it, mostly before the virus gets to harm the system.

Common means for malicious code to enter CBSs are electronic mail, electronic mail attachments, websites, removable media (for example, universal serial bus (USB) devices, diskettes or compact disks), PDF documents, web services, network connections and infected laptops.

### 2.3.3 Requirement details

Malware protection shall be implemented on CBSs in the scope of applicability of this Section. On CBSs having an operating system for which industrial-standard anti-virus and anti-malware software is available and maintained up-to-date, anti-virus and anti-malware software shall be installed, maintained and regularly updated, unless the installation of such software impairs the ability of CBS to provide the functionality and level of service required (e.g. for Cat.II and Cat.III CBSs performing real-time tasks).

On CBSs where anti-virus and anti-malware software cannot be installed, malware protection shall be implemented in the form of operational procedures, physical safeguards, or according to manufacturer's recommendations.

## 2.3.4 Demonstration of compliance

### 2.3.4.1 Design phase

The systems integrator shall include the following information in the Cyber security design description:

- For each CBS, summary of the approved mechanisms provided by the supplier for protection against malicious code or unauthorized software
- For CBSs with anti-malware software, information about how to keep the software updated.
- Any operational conditions or necessary physical safeguards to be implemented in the shipowner's management system.

### 2.3.4.2 Construction phase

The systems integrator shall ensure that malware protection is kept updated during the construction phase.

### 2.3.4.3 Commissioning phase

The systems integrator shall submit Ship cyber resilience test procedure (ref. [E.2.1](#)) and demonstrate the following to BKI:

- Approved anti-malware software or other compensating countermeasures is effective (test e.g., with a trustworthy anti-malware test file)

The above tests may be omitted if performed during the certification of CBSs as per [E.2.1](#).

### 2.3.4.4 Operation phase

For general requirements to surveys in the operation phase, see [E.3.](#)

The shipowner shall in the Ship cyber security and resilience program describe the management of malware protection, addressing at least the following requirements in this Section:

- Maintenance/update ([D.2.3.3](#))
- Operational procedures, physical safeguards ([D.2.3.3](#))
- Use of mobile, portable, removable media ([2.4.3.4](#) and [D.2.7.3](#))
- Access control ([D.2.4](#))

#### First annual survey

The shipowner shall present to BKI records or other documented evidence demonstrating implementation of the Ship cyber security and resilience program, i.e., that:

- Any anti-malware software has been maintained and updated.
- Procedures for use of portable, mobile or removable devices have been followed.
- Policies and procedures for access control have been followed.
- Physical safeguards are maintained

#### Subsequent annual surveys

The shipowner shall upon request by BKI demonstrate implementation of the Ship cyber security and resilience program by presenting records or other documented evidence as specified for the first annual survey.

#### Special survey

The shipowner shall demonstrate to BKI the activities in [2.3.4.3](#) as per the Ship cyber resilience test procedure



## **2.4 Access control**

### **2.4.1 Requirement**

CBSs and networks in the scope of applicability of this Section shall provide physical and/or logical/digital measures to selectively limit the ability and means to communicate with or otherwise interact with the system itself, to use system resources to handle information, to gain knowledge of the information the system contains or to control system components and functions. Such measures shall be such as not to hamper the ability of authorized personnel to access CBS for their level of access according to the least privilege principle.

### **2.4.2 Rationale**

Attackers may attempt to access the ship's systems and data from either onboard the ship, within the company, or remotely through connectivity with the internet. Physical and logical access controls to cyber assets, networks etc. shall then be implemented to ensure safety of the ship and its cargo.

Physical threats and relevant countermeasures are also considered in the ISPS Code. Similarly, the ISM Code contains guidelines to ensure safe operation of ships and protection of the environment. Implementation of ISPS and ISM Codes may imply inclusion in the Ship Security Plan (SSP) and Safety Management System (SMS) of instructions and procedures for access control to safety critical assets.

### **2.4.3 Requirement details**

Access to CBSs and networks in the scope of applicability of this Section and all information stored on such systems shall only be allowed to authorized personnel, authorized processes and devices, based on their need to access the information as a part of their responsibilities or their intended functionality.

#### **2.4.3.1 Physical access control**

CBSs of Cat.II and Cat.III shall be located in rooms that can normally be locked or in controlled space to prevent unauthorized access, or shall be installed in lockable cabinets or consoles. Such locations or lockable cabinets/consoles shall be however easy to access to the crew and various stakeholders who need to access to CBSs for installation, integration, maintenance, repair, replacement, disposal etc. so as not to hamper effective and efficient operation of the ship.

#### **2.4.3.2 Physical access control for visitors**

Visitors such as authorities, technicians, agents, port and terminal officials, and owner representatives shall be restricted regarding access to CBSs onboard whilst on board, e.g. by allowing access under supervision.

#### **2.4.3.3 Physical access control of network access points**

Access points to onboard networks connecting Cat.II and/or Cat.III CBSs shall be physically and/or logically blocked except when connection occurs under supervision or according to documented procedures, e.g. for maintenance.

Independent computers isolated from all onboard networks, or other networks, such as dedicated guest access networks, or networks dedicated to passenger recreational activities, shall be used in case of occasional connection requested by a visitor (e.g. for printing documents).

#### **2.4.3.4 Removable media controls**

A policy for the use of removable media devices shall be established, with procedures to check removable media for malware and/or validate legitimate software by digital signatures and watermarks and scan prior

to permitting the uploading of files onto a ship's system or downloading data from the ship's system. See also [D.2.7](#).

#### 2.4.3.5 Management of credentials

CBSs and relevant information shall be protected with file system, network, application, or database specific Access Control Lists (ACL). Accounts for onboard and onshore personnel shall be left active only for a limited period according to the role and responsibility of the account holder and shall be removed when no longer needed.

Onboard CBSs shall be provided with appropriate access control that fits to the policy of their Security Zone but does not adversely affect their primary purpose. CBSs which require strong access control may need to be secured using a strong encryption key or multi-factor authentication.

Administrator privileges allowing full access to system configuration settings and all data shall only be given to appropriately trained personnel, who as part of their role in the company or onboard, need to log onto systems using these privileges.

#### 2.4.3.6 Least privilege policy

Any user, program, or process allowed to access CBS and networks in the scope of applicability of this Section shall have only the bare minimum privileges necessary to perform its function.

The default configuration for all new account or process privileges shall be set as low as possible. Wherever possible, raised privileges shall be restricted only to moments when they are needed, e.g. using only expiring privileges and one-time-use credentials. Accumulation of privileges over time shall be avoided, e.g. by regular auditing of user and process accounts.

### 2.4.4 Demonstration of compliance

#### 2.4.4.1 Design phase

The systems integrator shall include the following information in the Cyber security design description:

- Location and physical access controls for the CBSs. Devices providing Human Machine Interface (HMI) for operators needing immediate access need not enforce user identification and authentication provided they are located in an area with physical access control. Such devices shall be specified.

#### 2.4.4.2 Construction phase

The systems integrator shall prevent unauthorised access to the CBSs during the construction phase.

#### 2.4.4.3 Commissioning phase

The systems integrator shall submit Ship cyber resilience test procedure (ref. [E.2.1](#)) and demonstrate the following to BKI:

- Components of the CBSs are located in areas or enclosures where physical access can be controlled to authorised personnel.
- User accounts are configured according to the principles of segregation of duties and least privilege and that temporary accounts have been removed (may be omitted based on certification of CBSs as per [E.2.1](#))

#### 2.4.4.4 Operation phase

For general requirements to surveys in the operation phase, see [E.3.](#)

The shipowner shall in the Ship cyber security and resilience program describe the management of logical and physical access, addressing at least the following requirements in this Section:

- Physical access control ([2.4.3.1](#))
- Physical access control for visitors ([2.3.4.2](#))
- Physical access control of network access points ([2.4.3.3](#))
- Management of credentials ([2.4.3.5](#))
- Least privilege policy ([2.4.3.6](#))

The shipowner shall in the Ship cyber security and resilience program describe the management of confidential information, addressing at least the following requirements in this Section:

- Confidential information ([D.1.1.3](#))
- Information allowed to authorized personnel ([D.2.4.3](#))
- Information transmitted on the wireless network ([D.2.5.3](#))

#### First annual survey

The shipowner shall present to BKI records or other documented evidence demonstrating implementation of the Ship cyber security and resilience program, i.e., that:

- Personnel are authorized to access the CBSs in accordance with their responsibilities.
- Only authorised devices are connected to the CBSs.
- Visitors are given access to the CBSs according to relevant policies and procedures.
- Physical access controls are maintained and applied.
- Credentials, keys, secrets, certificates, relevant CBS documentation, and other sensitive information is managed and kept confidential according to relevant policies and procedures.

#### Subsequent annual surveys

The shipowner shall upon request by BKI demonstrate implementation of the Ship cyber security and resilience program by presenting records or other documented evidence as specified for the first annual survey.

### 2.5 Wireless communication

#### 2.5.1 Requirement

Wireless communication networks in the scope of this Section shall be designed, implemented and maintained to ensure that:

- Cyber incidents will not propagate to other control systems
- Only authorised human users will gain access to the wireless network
- Only authorised processes and devices will be allowed to communicate on the wireless network
- Information in transit on the wireless network cannot be manipulated or disclosed

## 2.5.2 Rationale

Wireless networks give rise to additional or different cybersecurity risks than wired networks. This is mainly due to less physical protection of the devices and the use of the radio frequency communication.

Inadequate physical access control may lead to unauthorised personnel gaining access to the physical devices, which in turn could lead to circumventing logical access restrictions or deployment of rogue devices on the network.

Signal transmission by radio frequency introduces risks related to jamming as well as eavesdropping which in turn could cater for attacks such as Piggybacking or Evil twin attacks (see <https://us-cert.cisa.gov/ncas/tips/ST05-003>).

## 2.5.3 Requirement details

Cryptographic mechanisms such as encryption algorithms and key lengths in accordance with industry standards and best practices shall be applied to ensure integrity and confidentiality of the information transmitted on the wireless network.

Devices on the wireless network shall only communicate on the wireless network (i.e. they shall not be “dual-homed”)

Wireless networks shall be designed as separate segments in accordance with D.2.1 and protected as per D.2.2.

Wireless access points and other devices in the network shall be installed and configured such that access to the network can be controlled.

The network device or system utilizing wireless communication shall provide the capability to identify and authenticate all users (humans, software processes or devices) engaged in that communication.

## 2.5.4 Demonstration of compliance

### 2.5.4.1 Design phase

The systems integrator shall include the following information in the Cyber security design description:

- Description of wireless networks in the scope of applicability of this Section and how these are implemented as separate security zones. The description shall include zone boundary devices and specify the traffic that is permitted to traverse the zone boundary (e.g. firewall rules)

### 2.5.4.2 Construction phase

The systems integrator shall prevent unauthorised access to the wireless networks during the construction phase.

### 2.5.4.3 Commissioning phase

The systems integrator shall submit Ship cyber resilience test procedure (ref. E.2.1) and demonstrate the following to BKI:

- Only authorised devices can access the wireless network.
- Secure wireless communication protocol is used as per approved documentation by the respective supplier (demonstrate e.g. by use of a network protocol analyser tool).

The above tests may be omitted if performed during the certification of CBSs as per E.2.1.

#### 2.5.4.4 Operation phase

For general requirements to surveys in the operation phase, see [E.3](#).

##### Special survey

Subject to modifications of the wireless networks in the scope of applicability of this Section, the shipowner shall demonstrate to BKI the activities in [2.5.4.3](#) as per the Ship cyber resilience test procedure.

### 2.6 Remote access control and communication with untrusted networks

#### 2.6.1 Requirement

CBSs in scope of this Section shall be protected against unauthorized access and other cyber threats from untrusted networks.

#### 2.6.2 Rationale

Onboard CBSs have become increasingly digitalized and connected to the internet to perform a wide variety of legitimate functions. The use of digital systems to monitor and control onboard CBSs makes them vulnerable to cyber incidents. Attackers may attempt to access onboard CBSs through connectivity with the internet and may be able to make changes that affect a CBS's operation or even achieve full control of the CBS, or attempt to download information from the ship's CBS. In addition, since use of legacy IT and OT systems that are no longer supported and/or rely on obsolete operating systems affects a lot cyber resilience, special care should be put to relevant hardware and software installations on board to help maintain a sufficient level of cyber resilience when such systems can be remotely accessed, also keeping in mind that not all cyber incidents are a result of a deliberate attack.

#### 2.6.3 Requirement details

User's manual shall be delivered for control of remote access to onboard IT and OT systems. Clear guidelines shall identify roles and permissions with functions.

For CBSs in the scope of application of this Section, no IP address shall be exposed to untrusted networks. It shall not be possible to route packets directly to security zones from untrusted networks.

Communication with or via untrusted networks requires secure connections (e.g. tunnels) with endpoint authentication, protection of integrity and authentication and encryption at network or transport layer. Confidentiality shall be ensured for information that is subject to read authorization.

##### 2.6.3.1 Design

CBSs in the scope of applicability of this Section shall:

- have the capability to terminate a connection from the onboard connection endpoint. Any remote access shall not be possible until explicitly accepted by a responsible role on board.
- be capable of managing interruptions during remote sessions so as not to compromise the safe functionality of OT systems or the integrity and availability of data used by OT systems.
- provide a logging function to record all remote access events and retain for a period of time sufficient for offline review of remote connections, e.g. after detection of a cyber incident.

### 2.6.3.2 Additional requirements for remote maintenance

When remote access is used for maintenance, the following requirements shall be complied with in addition to those in [D.2.6.3.1](#):

- Documentation shall be provided to show how they connect and integrate with the shore side.
- Security patches and software updates shall be tested and evaluated before they are installed to ensure they are effective and do not result in side effects or cyber events that cannot be tolerated. A confirmation report from the software supplier towards above shall be obtained, prior to undertaking remote update.
- **Suppliers shall provide plans for and make security updates available to the shipowner, see Section 25 E.2., E.3. and E.4.**
- At any time, during remote maintenance activities, authorized personnel shall have the possibility to interrupt and abort the activity and roll back to a previous safe configuration of the CBS and systems involved.
- Multi-factor authentication is required for any access by human users to CBS's in scope from an untrusted network.
- **After a configurable number of failed remote access attempts, the next attempt shall be blocked for a predetermined length of time**
- If the connection to the remote maintenance location is disrupted for some reason, access to the system shall be terminated by an automatic logout function.

## 2.6.4 Demonstration of compliance

### 2.6.4.1 Design phase

The systems integrator shall include the following information in the Cyber security design description:

- Identification of each CBS in the scope of applicability of this Section that can be remotely accessed or that otherwise communicates through the security zone boundary with untrusted networks.
- For each CBS, a description of compliance with requirements in [D.2.6.3](#), as applicable

### 2.6.4.2 Construction phase

The systems integrator shall ensure that any communication with untrusted networks is only temporarily enabled and used in accordance with the requirements of this section.

### 2.6.4.3 Commissioning phase

The systems integrator shall submit Ship cyber resilience test procedure (ref. [E.2.1](#)) and demonstrate the following to BKI:

- Communication with untrusted networks is secured in accordance with Section [D.2.](#) and that the communication protocols cannot be negotiated to a less secure version (demonstrate e.g., by use of a network protocol analyzer tool).
- Remote access requires multifactor authentication of the remote user.
- A limit of unsuccessful login attempts is implemented, and that a notification message is provided for the remote user before session is established.

- Remote connections must be explicitly accepted by responsible personnel on board.
- Remote sessions can be manually terminated by personnel on board or that the session will automatically terminate after a period of inactivity.
- Remote sessions are logged (see Section [D.1](#). item 13).
- Instructions or procedures are provided by the respective product suppliers (see Section [C.1.3](#)).

#### 2.6.4.4 Operation phase

For general requirements to surveys in the operation phase, see [E.3](#).

The shipowner shall in the Ship cyber security and resilience program describe the management of remote access and communication with/via untrusted networks, addressing at least the following requirements in this Section:

- User's manual ([D.2.6.3](#))
- Roles and permissions ([D.2.6.3](#))
- Patches and updates ([D.2.6.3.2](#))
- Confirmation prior to undertaking remote software update ([D.2.6.3.2](#))
- Interrupt, abort, roll back ([D.2.6.3.2](#))

#### First annual survey

The shipowner shall present to BKI records or other documented evidence demonstrating implementation of the Ship cyber security and resilience program, i.e., that:

- Remote access sessions have been recorded or logged and carried out as per relevant policies and user manuals.
- Installation of security patches and other software updates have been carried out in accordance with Management of change procedures and in cooperation with the supplier.

#### Annual survey

The shipowner shall upon request by BKI demonstrate implementation of the Ship cyber security and resilience program by presenting records or other documented evidence as specified for the first annual survey

#### Special survey

The shipowner shall demonstrate to BKI the activities in [2.6.4.3](#) as per the Ship cyber resilience test procedure.

## 2.7 Use of Mobile and Portable Devices

### 2.7.1 Requirement

The use of mobile and portable devices in CBSs in the scope of applicability of this Section shall be limited to only necessary activities and be controlled in accordance with [D.1](#). item 10. For any CBS that cannot fully meet these requirements, the interface ports shall be physically blocked.

Wireless connected mobile and portable devices shall be compliant with requirements of [D.2.5](#).

## 2.7.2 Rationale

It is generally known that CBSs can be impaired due to malware infection via a mobile or a portable device. Therefore, connection of mobile and portable devices shall be carefully considered. In addition, mobile equipment that is required to be used for the operation and maintenance of the ship shall be under the control of the Shipowner.

## 2.7.3 Requirement details

Mobile and portable devices shall only be used by authorised personnel. Only authorised devices may be connected to the CBSs. All use of such devices shall be in accordance with the shipowner's policy for use of mobile and portable devices, taking into account the risk of introducing malware in the CBS.

## 2.7.4 Demonstration of compliance

### 2.7.4.1 Design phase

The systems integrator shall include the following information in the Cyber security design description:

- Any CBSs in the scope of applicability that do not meet the requirements in Section D.1. item 10, i.e., that shall have protection of interface ports by physical means such as port blockers.

### 2.7.4.2 Construction phase

The systems integrator shall ensure that use of physical interface ports in the CBSs is controlled in accordance with Section D.1. item 10, and that any use of such devices follows procedures to prevent malware from being introduced in the CBS.

### 2.7.4.3 Commissioning phase

The systems integrator shall submit Ship cyber resilience test procedure (ref. E.2.1) and demonstrate to BKI that capabilities to control use of mobile and portable devices are implemented correctly, the following countermeasures shall be demonstrated as relevant:

- Use of mobile and portable devices is restricted to authorised users
- Interface ports can only be used by specific device types
- Files cannot be transferred to the system from such devices
- Files on such devices will not be automatically executed (by disabling autorun)
- Network access is limited to specific MAC or IP addresses
- Unused interface ports are disabled
- Unused interface ports are physically blocked

### 2.7.4.4 Operation phase

For general requirements to surveys in the operation phase, see E.3..

The shipowner shall in the Ship cyber security and resilience program describe the management of mobile and portable devices, addressing at least the following requirements in this Section:

- Policy and procedures (2.4.3.4)



- Physical block of interface ports (D.2.7.1)
- Use by authorized personnel (D.2.7.3)
- Connect only authorized devices (D.2.7.3)
- Consider risk of introducing malware (D.2.7.3)

### First annual survey

The shipowner shall present to BKI records or other documented evidence demonstrating implementation of the Ship cyber security and resilience program, i.e., that:

- The use of mobile, portable or removable media is restricted to authorised personnel and follows relevant policies and procedures.
- Only authorised devices are connected to the CBSs.
- Means to restrict use of physical interface ports are implemented as per approved design documentation.

### Subsequent annual surveys

The shipowner shall upon request by BKI demonstrate implementation of the Ship cyber security and resilience program by presenting records or other documented evidence as specified for the first annual survey.

### Special survey

The shipowner shall demonstrate to BKI the activities in 2.7.4.3 as per the Ship cyber resilience test procedure

## 3. Detect

The requirements for the Detect functional element are aimed at the development and implementation of appropriate means supporting the ability to reveal and recognize anomalous activity on CBSs and networks onboard and identify cyber incidents.

### 3.1 Network operation monitoring

#### 3.1.1 Requirement

Networks in scope of this Section shall be continuously monitored, and alarms shall be generated if malfunctions or reduced/degraded capacity occurs.

#### 3.1.2 Rationale

Cyber-attacks are becoming increasingly sophisticated, and attacks that target vulnerabilities that were unknown at the time of construction could result in incidents where the vessel is ill-prepared for the threat. To enable an early response to attacks targeting these types of unknown vulnerabilities, technology capable of detecting unusual events is required. A monitoring system that can detect anomalies in networks and that can use post-incident analysis provides the ability to appropriately respond and further recover from a cyber event.

### 3.1.3 Requirement details

Measures to monitor networks in the scope of applicability of this Section shall have the following capabilities:

- Monitoring and protection against excessive traffic
- Monitoring of network connections
- Monitoring and recording of device management activities
- Protection against connection of unauthorized devices
- **Generate alarm if utilization of the network's bandwidth exceeds a threshold specified as abnormal by the supplier. See [Section 10.G.2.1](#)**

Intrusion detection systems (IDS) may be implemented, subject to the following:

- The IDS shall be qualified by the supplier of the respective CBS
- The IDS shall be passive and not activate protection functions that may affect the performance of the CBS
- Relevant personnel should be trained and qualified for using the IDS

### 3.1.4 Demonstration of compliance

#### 3.1.4.1 Design phase

No requirements.

#### 3.1.4.2 Construction phase

No requirements.

#### 3.1.4.3 Commissioning phase

The systems integrator shall specify in the Ship cyber resilience test procedure and demonstrate to BKI the network monitoring and protection mechanisms in the CBSs.

- Test that disconnected network connections will activate alarm and that the event is recorded.
- Test that abnormally high network traffic is detected, and that alarm and audit record is generated. This test may be carried on together with the test in [4.4.4.3](#).
- Demonstrate that the CBS will respond in a safe manner to network storm scenarios, considering both unicast and broadcast messages (see also [2.2.4.3](#))
- Demonstrate generation of audit records (logging of security-related events)
- If Intrusion detection systems are implemented, demonstrate that this is passive and will not activate protection functions that may affect intended operation of the CBSs.

The above tests may be omitted if performed during the certification of CBSs as per [E.2.1](#).

Any Intrusion detection systems in the CBSs in scope of applicability to be implemented shall be subject to verification by BKI. Relevant documentation shall be submitted for approval, and survey/tests shall be carried out on board.

#### 3.1.4.4 Operation phase

For general requirements to surveys in the operation phase, see [E.3.](#)

The shipowner shall in the Ship cyber security and resilience program describe the management activities to detect anomalies in the CBSs and networks, addressing at least the following requirements in this Section:

- Reveal and recognize anomalous activity ([C.3.](#))
- Inspection of security audit records ([D.3.1.3](#))
- Instructions or procedures to detect incidents ([D.4.1.1](#))

The above activities may be addressed together with incident response in [D.4.1.](#)

##### First annual survey

The shipowner shall present to BKI records or other documented evidence demonstrating implementation of the Ship cyber security and resilience program, i.e., that:

- The CBSs are routinely monitored for anomalies by inspection of security audit records and investigation of alerts in the CBSs.

##### Subsequent annual surveys

The shipowner shall upon request by BKI demonstrate implementation of the Ship cyber security and resilience program by presenting records or other documented evidence as specified for the first annual survey.

##### Special survey

Subject to modifications of the CBSs, the shipowner shall demonstrate to BKI the activities in [3.1.4.3](#) as per the Ship cyber resilience test procedure.

### 3.2 Verification and diagnostic functions of CBS and networks

#### 3.2.1 Requirement

CBSs and networks in the scope of applicability of this Section shall be capable to check performance and functionality of security functions required by this Section. Diagnostic functions shall provide adequate information on CBSs integrity and status for the use of the intended user and means for maintaining their functionality for a safe operation of the ship.

#### 3.2.2 Rationale

The ability to verify intended operation of the security functions is important to support management of cyber resilience in the lifetime of the ship. Tools for diagnostic functions may comprise automatic or manual functions such as self-diagnostics capabilities of each device, or tools for network monitoring (such as ping, traceroute, ipconfig, netstat, nslookup, Wireshark, nmap, etc.).

It should be noted however that execution of diagnostic functions may sometimes impact the operational performance of the CBS.

#### 3.2.3 Requirement details

CBSs and networks' diagnostics functionality shall be available to verify the intended operation of all required security functions during test and maintenance phases of the ship.

### 3.2.4 Demonstration of compliance

#### 3.2.4.1 Design phase

No requirements.

#### 3.2.4.2 Construction phase

No requirements.

#### 3.2.4.3 Commissioning phase

The systems integrator shall submit Ship cyber resilience test procedure (ref. [E.2.1](#)) and demonstrate to BKI the effectiveness of the procedures for verification of security functions provided by the suppliers.

The above tests may be omitted if performed during the certification of CBSs as per [E.2.1](#)

#### 3.2.4.4 Operation phase

For general requirements to surveys in the operation phase, see [E.3.](#)

The shipowner shall in the Ship cyber security and resilience program describe the management activities to verify correct operation of the security functions in the CBSs and networks, addressing at least the following requirements in this Section:

- Test and maintenance periods ([D.3.2.3](#))
- Periodic maintenance ([E.3.3](#))

#### First annual survey

The shipowner shall present to BKI records or other documented evidence demonstrating implementation of the Ship cyber security and resilience program, i.e., that:

- The security functions in the CBSs are periodically tested or verified.

#### Subsequent annual surveys

The shipowner shall upon request by BKI demonstrate implementation of the Ship cyber security and resilience program by presenting records or other documented evidence as specified for the first annual survey.

## 4. Respond

The requirements for the Respond functional element are aimed at the development and implementation of appropriate means supporting the ability to minimize the impact of cyber incidents, containing the extension of possible impairment of CBSs and networks onboard.

### 4.1 Incident response plan

#### 4.1.1 Requirement

An incident response plan shall be developed covering relevant contingencies and specifying how to react to cyber security incidents. The Incident response plan shall contain documentation of a predetermined set of instructions or procedures to detect, respond to, and limit consequences of incidents against CBSs in the scope of applicability of this Section.

#### 4.1.2 Rationale

An incident response plan is an instrument aimed to help responsible persons respond to cyber incidents. As such, the Incident response plan is as effective as it is simple and carefully designed. When developing the Incident response plan, it is important to understand the significance of any cyber incident and prioritize response actions accordingly.

Means for maintaining as much as possible the functionality and a level of service for a safe operation of the ship, e.g. transfer active execution to a standby redundant unit, should also be indicated. Designated personnel ashore shall be integrated with the ship in the event of a cyber incident.

#### 4.1.3 Requirement details

The various stakeholders involved in the design and construction phases of the ship shall provide information to the Shipowner for the preparation of the Incident Response Plan to be placed onboard at the first annual Survey. The Incident Response Plan shall be kept up-to-date (e.g. upon maintenance) during the operational life of the ship.

The Incident response plan shall provide procedures to respond to detected cyber incidents on networks by notifying the proper authority, reporting needed evidence of the incidents and taking timely corrective actions, to limit the cyber incident impact to the network segment of origin.

The incident response plan shall, as a minimum, include the following information:

- Breakpoints for the isolation of compromised systems;
- A description of alarms and indicators signalling detected ongoing cyber events or abnormal symptoms caused by cyber events;
- A description of expected major consequences related to cyber incidents;
- Response options, prioritizing those which do not rely on either shut down or transfer to independent or local control, if any.
- Independent and local control information for operating independently from the system that failed due to the cyber incident, as applicable;

The Incident response plan shall be kept in hard copy in the event of complete loss of electronic devices enabling access to it.

#### 4.1.4 Demonstration of compliance

##### 4.1.4.1 Design phase

The systems integrator shall include the following information in the Cyber security design description:

- References to information provided by the suppliers (see Section [C.1.8](#)) that may be applied by the shipowner to establish plans for incident response.

##### 4.1.4.2 Construction phase

No requirements.

##### 4.1.4.3 Commissioning phase

No requirements.

#### 4.1.4.4 Operation phase

For general requirements to surveys in the operation phase, see [E.3.](#)

The shipowner shall in the Ship cyber security and resilience program describe incident response plans. The plans shall cover the CBSs in scope of applicability of this Section and shall address at least the following requirements in this Section:

- Description of who, when and how to respond to cyber incidents in accordance with requirements of [D.4.1](#)
- Procedures or instructions for local/manual control in accordance with requirements in [D.4.2](#)
- Procedures or instructions for isolation of security zones in accordance with requirements in [D.4.3](#)
- Description of expected behaviour of the CBSs in the event of cyber incidents in accordance with requirements in [D.4.4](#).

#### First annual survey

The shipowner shall present to BKI records or other documented evidence demonstrating implementation of the Ship cyber security and resilience program, i.e., that:

- The incident response plans are available for the responsible personnel onboard.
- Procedures or instructions for local/manual controls are available for responsible personnel onboard.
- Procedures or instructions for disconnection/isolation of security zones are available for responsible personnel onboard.
- Any cyber incidents have been responded to in accordance with the incident response plans.

#### Subsequent annual surveys

The shipowner shall upon request by BKI demonstrate implementation of the Ship cyber security and resilience program by presenting records or other documented evidence as specified for the first annual survey

## 4.2 Local, independent and/or manual operation

### 4.2.1 Requirement

Any CBS needed for local backup control as required by SOLAS II-1 Regulation 31 shall be independent of the primary control system. This includes also necessary Human Machine Interface (HMI) for effective local operation.

### 4.2.2 Rationale

Independent local controls of machinery and equipment needed to maintain safe operation is a fundamental principle for manned vessels. The objective of this requirement has traditionally been to ensure that personnel can cope with failures and other incidents by performing manual operations in close vicinity of the machinery. Since incidents caused by malicious cyber events shall also be considered, this principle of independent local control is no less important.

### 4.2.3 Requirement details

The CBS for local control and monitoring shall be self-contained and not depend on communication with other CBS for its intended operation.

If communication to the remote control system or other CBS's is arranged by networks, segmentation and protection safeguards as described in [D.2.1](#) and [D.2.2](#) shall be implemented. This implies that the local control and monitoring system shall be considered a separate security zone. **Notwithstanding the above, special considerations can be given to CBSs with different concepts on case by case basis**

The CBS for local control and monitoring shall otherwise comply with requirements in this Section.

### 4.2.4 Demonstration of compliance

#### 4.2.4.1 Design phase

The systems integrator shall include the following information in the Cyber security design description:

- Description of how the local controls specified in SOLAS II-1 Reg.31 are protected from cyber incidents in any connected remote or automatic control systems.

#### 4.2.4.2 Construction phase

No requirements.

#### 4.2.4.3 Commissioning phase

The systems integrator shall submit Ship cyber resilience test procedure (ref. [E.2.1](#)) and demonstrate to BKI that the required local controls in the scope of applicability of this Section needed for safety of the ship can be operated independently of any remote or automatic control systems. The tests shall be carried out by disconnecting all networks from the local control system to other systems/devices.

The above tests may be omitted if performed during the certification of CBSs as per [E.2.1](#).

#### 4.2.4.4 Operation phase

For general requirements to surveys in the operation phase, see [E.3](#).

#### Special survey

Subject to modifications of the CBSs, the shipowner shall demonstrate to BKI the activities in [4.2.4.3](#) as per the Ship cyber resilience test procedure

## 4.3 Network isolation

### 4.3.1 Requirement

It shall be possible to manually or automatically terminate network-based communication to or from a security zone.

### 4.3.2 Rationale

In the event that a security breach has occurred and is detected, it is likely that the incident response plan includes actions to prevent further propagation and effects of the incident. Such actions could be to isolate network segments and control systems supporting essential functions.

### 4.3.3 Requirement details

Where the Incident Response Plan indicates network isolation as an action to be done, it shall be possible to isolate physical network segments according to the indicated procedure, e.g. by operating a physical ON/OFF switch on the network device or similar actions such as disconnecting a cable to the router/firewall. There shall be available instructions and clear marking on the device that allows the personnel to isolate the network in an efficient manner.

Individual system's data dependencies that may affect function and correct operation, including safety, shall be identified, clearly showing where systems must have compensations for data or functional inputs if isolated during a contingency.

### 4.3.4 Demonstration of compliance

#### 4.3.4.1 Design phase

The systems integrator shall include the following information in the Cyber security design description:

- specification of how to isolate each security zone from other zones or networks. The effects of such isolation shall also be described, demonstrating that the CBSs in a security zone do not rely on data transmitted by IP-networks from other zones or networks.

#### 4.3.4.2 Construction phase

No requirements.

#### 4.3.4.3 Commissioning phase

The systems integrator shall submit Ship cyber resilience test procedure (ref. [E.2.1](#)) and demonstrate to BKI by disconnecting all networks traversing security zone boundaries, that the CBSs in the security zone will maintain adequate operational functionality without network communication with other security zones or networks.

The above tests may be omitted if performed during the certification of CBSs as per [E.2.1](#)

#### 4.3.4.4 Operation phase

For general requirements to surveys in the operation phase, see [E.3.](#)

##### Special survey

Subject to modifications of the CBSs, the shipowner shall demonstrate to BKI the activities in [D.4.3.4.3](#) as per the Ship cyber resilience test procedure.

## 4.4 Fallback to a minimal risk condition

### 4.4.1 Requirement

In the event of a cyber incident impairing the ability of a CBS or network in the scope of applicability of this Section to provide its intended service, the affected system or network shall fall back to a minimal risk condition, i.e. bring itself in a stable, stopped condition to reduce the risk of possible safety issues.

### 4.4.2 Rationale

The ability of a CBS and integrated systems to fallback to one or more minimal risk conditions to be reached in case of unexpected or unmanageable failures or events is a safety measure aimed to keep the system in a consistent, known and safe state.



Fallback to a minimal risk condition usually implies the capability of a system to abort the current operation and signal the need for assistance, and may be different depending on the environmental conditions, the voyage phase of the ship (e.g. port depart/arrival vs. open sea passage) and the events occurred.

#### 4.4.3 Requirement details

As soon as a cyber incident affecting the CBS or network is detected, compromising the system's ability to provide the intended service as required, the system shall fall back to a condition in which a reasonably safe state can be achieved. Fall-back actions may include:

- bringing the system to a complete stop;
- disengaging the system;
- transferring control to another system or human operator;
- other compensating actions.

Fall-back to minimum risk conditions shall occur in a time frame adequate to keep the ship in a safe condition.

The ability of a system to fall back to a minimal risk condition shall be considered from the design phase by the Supplier and the Shipyard / Ship Designer / System Integrator.

#### 4.4.4 Demonstration of compliance

##### 4.4.4.1 Design phase

The systems integrator shall include the following information in the Cyber security design description:

- Specification of safe state for the control functions in the CBSs in the scope of applicability of this Section.

##### 4.4.4.2 Construction phase

No requirements.

##### 4.4.4.3 Commissioning phase

The systems integrator shall submit Ship cyber resilience test procedure (ref. [E.2.1](#)) and demonstrate to BKI that CBSs in the scope of applicability of this Section respond to cyber incidents in a safe manner (as per [4.4.4.1](#)), e.g. by maintaining its outputs to essential services and allowing operators to carry out control and monitoring functions by alternative means. The tests shall at least include denial of service (DoS) attacks and may be done together with related test in [3.1.4.3](#).

The above tests may be omitted if performed during the certification of CBSs as per [E.2.1](#).

##### 4.4.4.4 Operation phase

For general requirements to surveys in the operation phase, see [E.3](#).

#### Special survey

Subject to modifications of the CBSs, the shipowner shall demonstrate to BKI the activities in [4.4.4.3](#) as per the Ship cyber resilience test procedure

## 5. Recover

The requirements for the Recover functional element are aimed at the development and implementation of appropriate means supporting the ability to restore CBSs and networks onboard affected by cyber incidents.

### 5.1 Recovery plan

#### 5.1.1 Requirement

A recovery plan shall be made to support restoring CBSs under the scope of applicability of this Section to an operational state after a disruption or failure caused by a cyber incident. Details of where assistance is available and by whom shall be part of the recovery plan.

#### 5.1.2 Rationale

Incident response procedures are an essential part of system recovery. Responsible personnel shall consider carefully and be aware of the implications of recovery actions (such as wiping of drives) and execute them carefully.

It should be noted, however, that some recovery actions may result in the destruction of evidence that could provide valuable information on the causes of an incident.

Where appropriate, professional cyber incident response support shall be obtained to assist in preservation of evidence whilst restoring operational capability.

#### 5.1.3 Requirement details

The various stakeholders involved in the design and construction phases of the ship shall provide information to the Shipowner for the preparation of the recovery plan to be placed onboard at the first annual Survey. The recovery plan shall be kept up-to-date (e.g. upon maintenance) during the operational life of the ship.

Recovery plans shall be easily understandable by the crew and external personnel and include essential instructions and procedures to ensure the recovery of a failed system and how to get external assistance if the support from ashore is necessary. In addition, software recovery medium or tools essential for recovery on board shall be available.

When developing recovery plans, the various systems and subsystems involved shall be specified. The following recovery objectives shall also be specified:

- 1) System recovery: methods and procedures to recover communication capabilities shall be specified in terms of Recovery Time Objective (RTO). This is defined as the time required to recover the required communication links and processing capabilities.
- 2) Data recovery: methods and procedures to recover data necessary to restore safe state of OT systems and safe ship operation shall be specified in terms of Recovery Point Objective (RPO). This is defined as the longest period of time for which an absence of data can be tolerated.

Once the recovery objectives are defined, a list of potential cyber incidents shall be created, and the recovery procedure developed and described. Recovery plans shall include, or refer to the following information:

- 1) Instructions and procedures for restoring the failed system without disrupting the operation from the redundant, independent or local operation.
- 2) Processes and procedures for the backup and secure storage of information.
- 3) Complete and up-to-date logical network diagram.

- 4) The list of personnel responsible for restoring the failed system.
- 5) Communication procedure and list of personnel to contact for external technical support including system support vendors, network administrators, etc.
- 6) Current configuration information for all components.

The operation and navigation of the ship shall be prioritized in the plan in order to help ensure the safety of onboard personnel.

Recovery plans in hard copy onboard and ashore shall be available to personnel responsible for cyber security and who are tasked with assisting in cyber incidents.

#### 5.1.4 Demonstration of compliance

##### 5.1.4.1 Design phase

The systems integrator shall include the following information in the Cyber security design description:

- references to information provided by the suppliers (see Section [C.1.8](#)) that may be applied by the shipowner to establish plans to recover from cyber incidents.

##### 5.1.4.2 Construction phase

No requirements.

##### 5.1.4.3 Commissioning phase

The systems integrator shall submit Ship cyber resilience test procedure (ref. [E.2.1](#)) and demonstrate to BKI the effectiveness of the procedures and instructions provided by the suppliers to respond to cyber incidents as specified in [D.5.2](#) and [D.5.3](#).

The above tests may be omitted if performed during the certification of CBSs as per [E.2.1](#).

##### 5.1.4.4 Operation phase

For general requirements to surveys in the operation phase, see [E.3](#).

The shipowner shall in the Ship cyber security and resilience program describe incident recovery plans. The plans shall cover the CBSs in scope of applicability of this Section and shall address at least the following requirements in this Section:

- Description of who, when and how to restore and recover from cyber incidents in accordance with requirements in [D.5.1](#).
- Policy for backup addressing frequency, maintenance and testing of the backups, considering acceptable downtime, availability of alternative means for control, vendor support arrangements and criticality of the CBSs in accordance with requirements in [D.5.2](#).
- Reference to user manuals or procedures for backup, shutdown, reset, restore and restart of the CBSs in accordance with requirements in [D.5.2](#) and [D.5.3](#).

#### First annual survey

The shipowner shall present to BKI records or other documented evidence demonstrating implementation of the Ship cyber security and resilience program, i.e., that:

- Instructions and/or procedures for incident recovery are available for the responsible personnel onboard.

- Equipment, tools, documentation, and/or necessary software and data needed for recovery is available for the responsible personnel onboard.
- Backup of the CBSs have been taken in accordance with the policies and procedures.
- Manuals and procedures for shutdown, reset, restore and restart are available for the responsible personnel onboard.

### Subsequent annual surveys

The shipowner shall upon request by BKI demonstrate implementation of the Ship cyber security and resilience program by presenting records or other documented evidence as specified for the first annual survey

## 5.2 Backup and restore capability

### 5.2.1 Requirement

CBSs and networks in the scope of applicability of this Section shall have the capability to support back-up and restore in a timely, complete and safe manner. Backups shall be regularly maintained and tested.

### 5.2.2 Rationale

In general, the purpose of a backup and restore strategy shall protect against data loss and reconstruct the database after data loss. Typically, backup administration tasks include the following: Planning and testing responses to different kinds of failures; Configuring the database environment for backup and recovery; Setting up a backup schedule; Monitoring the backup and recovery environment; Creating a database copy for long-term storage; Moving data from one database or one host to another, etc.

### 5.2.3 Requirement details

#### 5.2.3.1 Restore capability

CBSs in the scope of applicability of this Section shall have backup and restore capabilities to enable the ship to quickly and safely regain navigational and operational state after a cyber incident.

Data shall be restorable from a secure copy or image.

Information and backup facilities shall be sufficient to recover from a cyber incident.

#### 5.2.3.2 Backup

CBSs and networks in the scope of applicability of this Section shall provide backup for data. The use of offline backups shall also be considered to improve tolerance against ransomware and worms affecting online backup appliances.

Backup plans shall be developed, including scope, mode and frequency, storage medium and retention period.

## 5.2.4 Demonstration of compliance

### 5.2.4.1 Design phase

No requirements.

### 5.2.4.2 Construction phase

No requirements.

### 5.2.4.3 Commissioning phase

The systems integrator shall submit Ship cyber resilience test procedure (ref. [E.2.1](#)) and demonstrate to BKI the procedures and instructions for backup and restore provided by the suppliers for CBSs in the scope of applicability of this Section.

The above tests may be omitted if performed during the certification of CBSs as per [E.2.1](#)

### 5.2.4.4 Operation phase

For general requirements to surveys in the operation phase, see [E.3](#).

#### Special survey

Subject to modifications of the CBSs, the shipowner shall demonstrate to BKI the activities in [D.5.2.4.3](#) as per the Ship cyber resilience test procedure

## 5.3 Controlled shutdown, reset, roll-back and restart

### 5.3.1 Requirement

CBS and networks in the scope of applicability of this Section shall be capable of controlled shutdown, reset to an initial state, roll-back to a safe state and restart from a power-off condition in such state, in order to allow fast and safe recovery from a possible impairment due to a cyber incident.

Suitable documentation on how to execute the above-mentioned operations shall be available to onboard personnel.

### 5.3.2 Rationale

Controlled shutdown consists in turning a CBS or network off by software function allowing other connected systems to commit/rollback pending transactions, terminating processes, closing connections, etc. leaving the entire integrated system in a safe and known state.

Controlled shutdown is opposed to hard shutdown, which occurs for example when the computer is forcibly shut down by interruption of power.

While in the case of some cyber incidents hard shutdowns may be considered as a safety precaution, controlled shutdown is preferable in case of integrated systems to keep them in a consistent and known state with predictable behaviour. When standard shutdown procedures are not done, data or program and operating system files corruption may occur. In case of OT systems, the result of corruption can be instability, incorrect functioning or failure to provide the intended service.

The reset operation would typically kick off a soft boot, instructing the system to go through the process of shutting down, clear memory and reset devices to their initialized state. Depending on system considered, the reset operation might have different effects.

Rollback is an operation which returns the system to some previous state. Rollbacks are important for data and system integrity, because they mean that the system data and programs can be restored to a clean copy even after erroneous operations are performed. They are crucial for recovering from crashes and cyber incidents, restoring the system to a consistent state.

Restarting a system and reloading a fresh image of all the software and data (e.g. after a rollback operation) from a read-only source appears to be an effective approach to recover from unexpected faults or cyber incidents. Restart operations shall be however controlled in particular for integrated systems, where unexpected restart of a single component can result in inconsistent system state or unpredictable behaviour.

### 5.3.3 Requirement details

CBS and networks in the scope of applicability of this Section shall be capable of:

- controlled shutdown allowing other connected systems to commit/rollback pending transactions, terminating processes, closing connections, etc. leaving the entire integrated system in a safe, consistent and known state.
- resetting themselves, instructing the system to go through the process of shutting down, clear memory and reset devices to their initialized state.
- rolling back to a previous configuration and/or state, to restore system integrity and consistency.
- restarting and reloading a fresh image of all the software and data (e.g. after a rollback operation) from a read-only source. Restart time shall be compatible with the system's intended service and shall not bring other connected systems, or the integrated system it is part of, to an inconsistent or unsafe state.

Documentation shall be available to onboard personnel on how to execute the above- mentioned operations in case of a system affected by a cyber incident.

### 5.3.4 Demonstration of compliance

#### 5.3.4.1 Design phase

The systems integrator shall include the following information in the Cyber security design description:

- references to product manuals or procedures describing how to safely shut down, reset, restore and restart the CBSs in the scope of applicability of this Section.

#### 5.3.4.2 Construction phase

No requirements.

#### 5.3.4.3 Commissioning phase

The systems integrator shall submit Ship cyber resilience test procedure (ref. [E.2.1](#)) and demonstrate to BKI that manuals or procedures are established for shutdown, reset and restore of the CBSs in the scope of applicability of this Section. These manuals/procedures shall be provided to the shipowner.

The above tests may be omitted if performed during the certification of CBSs as per [E.2.1](#).

#### 5.3.4.4 Operation phase

For general requirements to surveys in the operation phase, see [E.3](#).

#### Special survey

Subject to modifications of the CBSs, the shipowner shall demonstrate to BKI the activities in [D.4.3.4.3](#) as per the Ship cyber resilience test procedure

### E. Demonstration of compliance

Evaluation of compliance with requirements in this Section shall be carried out by BKI by assessment of documentation and survey in the relevant phases as specified in the following subsections.

Documentation to be submitted by suppliers to BKI is specified in [Section 25](#). The approved versions of this documentation shall also be provided by the suppliers to the systems integrator as specified in [Section 25 F.2](#).

Documents to be provided by the systems integrator are listed in [E.1](#) and [E.2](#)

Documents to be provided by the shipowner are listed in [E.3](#)

Upon delivery of the ship, the systems integrator shall provide below documentation to the shipowner:

- Documentation of the CBSs provided by the suppliers (see [Section 25 F.2](#))
- Documentation produced by the systems integrator (see [E.1](#) and [E.2](#))

See also [G](#) and [H](#) for a summary of the documents.

## 1. During design and construction phases

The supplier shall demonstrate compliance to BKI by following the certification process specified in [Section 25.F](#).

The systems integrator shall demonstrate compliance by submitting documents in the following subsections to BKI for assessment.

During the design and construction phases, modifications to the design shall be carried out in accordance with the management of change (MoC) requirements in [Section 10](#).

### 1.1 Zones and conduit diagram

The content of this document is specified in [D.2.1.4.1](#).

### 1.2 Cyber security design description (CSDD)

The content of this document is specified in subsections “Design phase” for each requirement in [D](#).

### 1.3 Vessel asset inventory

The content of this document is specified in [D.1.1](#).

### 1.4 Risk assessment for the exclusion of CBSs

The content of this document is specified in [F](#).

### 1.5 Description of compensating countermeasures

If any CBS in the scope of applicability of this Section has been approved with compensating countermeasures in lieu of a requirement in [Section 25](#), this document shall specify the respective CBS, the lacking security capability, as well as provide a detailed description of the compensating countermeasures. See also [Section 25.C.1.3](#) requiring that the supplier describes such compensating countermeasures in the system documentation.

## 2. Upon ship commissioning

Before final commissioning of the ship, the systems integrator shall:

- 1) Submit updated design documentation to BKI (as-built versions of the documents in [E.1](#))
- 2) Submit Ship cyber resilience test procedure to BKI describing how to demonstrate compliance with this Section by testing and/or analytic evaluation.
- 3) Carry out testing, witnessed by BKI, in accordance with the approved Ship cyber resilience test procedure.

## 2.1 Ship cyber resilience test procedure

The content of this document is specified for the Commissioning phase in each subsection "Demonstration of compliance" in D.

For each CBS, the required inherent security capabilities and configuration thereof are verified and tested in the certification process of each CBS (see [Section 25](#)). Testing of such security functions may be omitted if specified in the respective subsection "Commissioning phase", on the condition that these security functions have been successfully tested during the certification of the CBS as per [Section 25](#). Nevertheless, all tests shall be included in the Ship cyber resilience test procedure and the decision to omit tests will be taken by BKI. Tests may generally not be omitted if findings/comments are carried over from the certification process to the commissioning phase, if the respective requirements have been met by compensating countermeasures, or due to other reasons such as modifications of the CBS after the certification process.

The Ship cyber resilience test procedure shall also specify how to test any compensating countermeasures described in [E.1.2](#).

The Ship cyber resilience test procedure shall include means to update status and record findings during the testing, and specify the following information:

- Necessary test setup (i.e. to ensure the test can be repeated with the same expected result)
- Test equipment
- Initial condition(s)
- Test methodology, detailed test steps
- Expected results and acceptance criteria

Before submitting the Ship cyber resilience test procedure to BKI, the systems integrator shall verify that the information is updated and placed under change management; that it is aligned with the latest configurations of CBSs and networks connecting such systems together onboard the ship and to other CBSs not onboard (e.g., ashore); and that the tests documented are sufficiently detailed as to allow verification of the installation and operation of measures adopted for the fulfilment of relevant requirements on the final configuration of CBSs and networks onboard.

The systems integrator shall document verification tests or assessments of security controls and measures in the fully integrated ship, maintaining change management for configurations, and noting in the documented test results where safety conditions may be affected by specific circumstances or failures addressed in the Ship cyber resilience test procedure.

The testing shall be carried out on board in accordance with the approved Ship cyber resilience test procedure after other commissioning activities for the CBSs are completed. BKI may request execution of additional tests.

## 3. During the operational life of the ship

After the ship has been delivered to the shipowner, the shipowner shall manage technical and organisational security countermeasures by establishing and implementing processes as specified in this Section.

Modifications to the CBSs in scope of applicability of this Section shall be carried out in accordance with the management of change (MoC) requirements in [Section 10](#). This includes keeping documentation of the CBSs up to date.

The shipowner, with the support of suppliers, shall keep the Ship cyber resilience test procedure up to date and aligned with the CBSs onboard the ship and the networks connecting such systems to each other and to other CBSs not onboard (e.g. ashore). The shipowner shall update the Ship cyber resilience test procedure considering the changes occurred on CBSs and networks onboard, possible emerging risks related to such changes, new threats, new vulnerabilities and other possible changes in the ship's operational environment.



The shipowner shall prepare and implement operational procedures, provide periodic training and carry out drills for the onboard personnel and other concerned personnel ashore to familiarize them with the CBSs onboard the ship and the networks connecting such systems to each other and to other CBSs onboard (e.g. ashore), and to properly manage the measures adopted for the fulfilment of requirements.

The shipowner, with the support of supplier, shall keep the measures adopted for the fulfilment of requirements up to date, e.g. by periodic maintenance of hardware and software of CBSs onboard the ship and the networks connecting such systems.

The shipowner shall retain onboard a copy of results of execution of tests and an updated Ship cyber resilience test procedure and make them available to BKI.

### 3.1 First annual survey

In due time before the first annual survey of the ship, the shipowner shall submit to BKI a Ship cyber security and resilience program documenting management of cyber security and cyber resilience of the CBSs in the scope of applicability of this Section.

The Ship cyber security and resilience program shall include policies, procedures, plans and/or other information documenting the processes/activities specified in subsections "Demonstration of compliance" in D of this Section.

After BKI has approved the Ship cyber security and resilience program, the shipowner shall in the first annual survey demonstrate compliance by presenting records or other documented evidence of implementation of the processes described in the approved Ship cyber security and resilience program.

Change of vessel management company will require a new verification of the Ship cyber security and resilience program.

### 3.2 Subsequent annual surveys

In the subsequent annual surveys of the ship, the shipowner shall upon request by BKI demonstrate implementation of the Ship cyber security and resilience program.

### 3.3 Special survey

Upon renewal of the ship's classification certificate, the shipowner shall carry out testing witnessed by BKI in accordance with the Ship cyber resilience test procedure. Certain security safeguards shall be demonstrated at Special survey whereas other need only be carried out upon request by BKI based on modifications to the CBSs as specified in subsections "Operation phase" in D.

## F. Risk assessment for exclusion of CBS from the application of requirements

### 1. Requirement

A risk assessment shall be carried out in case any of the CBSs falling under the scope of applicability of this Section is excluded from the application of relevant requirements. The risk assessment shall provide evidence of the acceptable risk level associated to the excluded CBSs.

### 2. Rationale

Exclusion of a CBS falling under the scope of applicability of this Section from the application of relevant requirements needs to be duly justified and documented. Such exclusion can be accepted by BKI only if evidence is given that the risk level associated to the operation of the CBS is under an acceptable threshold by means of specific risk assessment.

The risk assessment shall be based on available knowledge bases and experience on similar designs, if any, considering the CBS category and connectivity grade and the functional requirements and specifications of

the ship and of the CBS. Cyber threat information from internal and external sources may be used to gain a better understanding of the likelihood and impact of cybersecurity events.

### 3. Requirement details

Risk assessment shall be made and kept up to date by the Shipyard during the design and building phase and kept up to date considering possible variations of the original design and newly discovered threats and/or vulnerabilities not known from the beginning.

During the operational life of the ship, the Shipowner shall update the risk assessment considering the constant changes in the cyber scenario and new weaknesses identified in CBS onboard in a process of continuous improvement. Should new risks be identified, the Shipowner shall update existing, or implement new risk mitigation measures.

Should the changes in the cyber scenario be such as to elevate the risk level associated to the CBS under examination above the acceptable risk threshold, the Shipowner shall inform BKI and submit the updated risk assessment for evaluation.

The envisaged operational environments for the CBS under examination shall be analyzed in the risk assessment to discern the likelihood of cyber incidents and the impact they could have on the human safety, the safety of the vessel or the marine environment, taking into account the category of the CBS. The attack surface shall be analyzed, taking into account the connectivity grade of the CBS, possible interfaces for portable devices, logical access restrictions, etc.

Emerging risks related to the specific configuration of the CBS under examination shall be also identified. In the risk assessment, the following elements shall be considered:

- Asset vulnerabilities;
- Threats, both internal and external;
- Potential impacts of cyber incidents affecting the asset on human safety, safety of the vessel and/or threat to the environment;
- Possible effects related to integration of systems, or interfaces among systems, including systems not onboard (e.g. if remote access to onboard systems is provided).

### 4. Acceptance criteria

Exclusion of a CBS falling under the scope of applicability of this Section from the application of relevant requirements can be accepted by the BKI only if evidence is given that the operation of the CBS has no impact on the safety of operations regarding cyber risk. The said exclusion may be accepted for a CBS which does not fully meet the additional criteria listed below but is provided with a rational explanation together with evidence and is found satisfactory by BKI. BKI may also require to submit additional documents to consider the said exclusion.

**The following criteria shall be met to exclude a system from the scope of applicability of this Section:**

- 1) **The CBS shall be isolated (i.e. have no IP-network connections to other systems or networks)**
- 2) **The CBS shall have no accessible physical interface ports. Unused interfaces shall be logically disabled. It shall not be possible to connect unauthorised devices to the CBS**
- 3) **The CBS must be located in areas to which physical access is controlled**
- 4) **The CBS shall not be an integrated control system serving multiple ship functions as specified in the scope of applicability of this Section (see A.3)**

The following additional criteria should be considered for the evaluation of risk level acceptability:

- 1) The CBS should not serve ship functions of category III ;
- 2) Known vulnerabilities, threats, potential impacts deriving from a cyber incident affecting the CBS have been duly considered in the risk assessment;
- 3) The attack surface for the CBS is minimized, having considered its complexity, connectivity, physical and logical access points, including wireless access points;

#### G. Summary of actions and documents

Table 24.2: Legend

Submit	The stakeholder shall submit the document to BKI for verification and approval of compliance with requirements in this Section
Maintain	The stakeholder shall keep the document updated in accordance with procedure for management of change (MoC). Updated document and change management records shall be submitted to BKI as per <a href="#">Section 10</a>
Info	The document shall be submitted to BKI for information
Demonstrate	The stakeholder shall demonstrate compliance to BKI in accordance with the approved document.
1st AS	First annual survey
AS	Annual survey
SS	Special survey

**H. Summary of requirements and documents**

Document	systems integrator			Shipowner		
	Design	Construction	Commissioning	1st AS	AS	SS
Approved supplier documentation [E]		Maintain	Maintain			
Zones and conduit diagram [E.1.1]	Submit	Maintain	Maintain			
Cyber security design description [E.1.2]	Submit	Maintain	Maintain			
Vessel asset inventory [E.1.3]	Submit	Maintain	Maintain			
Risk assessment for the exclusion of CBSs [E.1.4] <sup>1</sup>	Submit	Maintain	Maintain			
Description of compensating countermeasures [E.1.5] <sup>1</sup>	Submit	Maintain	Maintain			
Ship cyber resilience test procedure [E.2.1]		Submit	Demonstrate			Demonstrate
Ship cyber security and resilience program [E.3.1]						
— Management of change (Moc) [D.1.1.4.4]						
— Management of software updates [D.1.1.4.4]						
— Management of firewalls [D.2.1.4.4]						
— Management of malware protection [D.2.3.4.4]						
— Management of access control [D.2.4.4.4]						
— Management of confidential information [D.2.4.4.4]						
— Management of remote access [D.2.6.4.4]						
— Management of mobile and portable devices [D.2.7.4.4]						
— Detection of security anomalies [D.3.1.4.4]						
— Verification of security functions [D.3.2.4.4]						
— Incident response plans [D.4.1.4.4]						
— Recovery plans [D.5.1.4.4]						
Note 1: If applicable						

<b>Vessel asset inventory (D.1.1)</b>	
CBS security capabilities	Provide documentation of product security updates Provide documentation of dependent component security updates Provide security updates Section 25 (E.2) Section 25 (E.3) Section 25 (E.4)
CBS documentation	CBS asset inventory Management of change plan Section 25 (C.1.1) Section 25 (C.1.9)
Vessel design documentation	Vessel asset inventory (D.1.1.4.1)
Ship cyber security and resilience program	Management of change (D.1.1.4.4) Management of software updates (D.1.1.4.4)
<b>Security zones and network segmentation (D.2.1)</b>	
CBS security capabilities	
CBS documentation	Topology diagrams Section 25 (C.1.2)
Vessel design documentation	Zones and conduit diagram (D.2.1.4.1) Design description (D.2.1.4.1) Ship cyber resilience test procedure (D.2.1.4.3)
Ship cyber security and resilience program	Management of security zone boundary devices (e.g., firewalls) (D.2.1.4.4)
<b>Network protection safeguards (D.2.2)</b>	
CBS security capabilities	Denial of service (DoS) protection (item 24) Section 25 (D.1) Deterministic output (item 20)
CBS documentation	Description of security capabilities Section 25 (C.1.3) Test procedure for security capabilities Section 25 (C.1.4)
Vessel design documentation	Ship cyber resilience test procedure (D.2.2.4.3)
Ship cyber security and resilience program	

<b>Antivirus, antimailware, anti spam and other protections from malicious code (D.2.3)</b>	
CBS security capabilities	Malicious code protection (#18) Section 25 (D.1)
CBS documentation	Description of security capabilities Test procedure for security capabilities Section 25 (C.1.3) Section 25 (C.1.4)
Vessel design documentation	Design description Ship cyber resilience test procedure (D.2.3.4.1) (D.2.3.4.3)
Ship cyber security and resilience program	Management of malware protection (D.2.3.4.4)
<b>Access control (D.2.4)</b>	
CBS security capabilities	Human user id. and auth. (#1) Account management (#2) Identifier management (#3) Authenticator management (#4) Authorisation enforcement (#8) Section 25 (D.1)
CBS documentation	Description of security capabilities Test procedure for security capabilities Section 25 (C.1.3) Section 25 (C.1.4)
Vessel design documentation	Design description Ship cyber resilience test procedure (D.2.4.4.1) (D.2.4.4.3)
Ship cyber security and resilience program	Management of confidential information Management of logical and physical access (D.2.4.4.4) (D.2.4.4.4)
<b>Wireless communication (D.2.5)</b>	
CBS security capabilities	Wireless access management (#5) Wireless use control (#9) Section 25(D.1)
CBS documentation	Description of security capabilities Test procedure for security capabilities Section 25 (C.1.3) Section 25 (C.1.4)
CBS documentation	Design description Ship cyber resilience test procedure (D.2.5.4.1) (D.2.5.4.3)
Ship cyber security and resilience program	

<b>Remote access control and communication with untrusted networks (D.2.6)</b>	
Description of security capabilities Multifactor authentication (#31) Process / device id. and auth. (#32) Unsuccessful login attempts (#33) System use notification (#34) Access via untrusted networks (#35) Explicit access request approval (#36) Remote session termination (#37) Cryptographic integrity protection (#38) Input validation (#39) Session integrity (#40) Invalidation of session ID (#41)	Section 25 (D.2)
CBS security capabilities	
CBS documentation	Section 25 (C.1.3) Section 25 (C.1.4)
Vessel design documentation	(D.2.6.4.1) (D.2.6.4.3)
Ship cyber security and resilience program	(D.2.6.4.4)
<b>Use of mobile and portable devices (D.2.7)</b>	
CBS security capabilities	Section 25 (D.1)
CBS documentation	Section 25 (C.1.3) Section 25 (C.1.4)
Vessel design documentation	(D.2.6.4.1) (D.2.6.4.3)
Ship cyber security and resilience program	(D.2.7.4.4)

<b>Network operation monitoring (D.3.1)</b>	
CBS security capabilities	Use control for portable devices (#10) Auditable events (#13) Denial of service (DoS) protection (#24) Alarm excessive bandwidth use
CBS documentation	Description of security capabilities Test procedure for security capabilities
Vessel design documentation	Ship cyber resilience test procedure
Ship cyber security and resilience program	Incident response plans
<b>Verification and diagnostic functions of CBS and networks (D.3.2)</b>	
CBS security capabilities	Security function verification (#19)
CBS documentation	Description of security capabilities Test procedure for security capabilities Plans for maintenance and verification
Vessel design documentation	Ship cyber resilience test procedure
Ship cyber security and resilience program	Verification of security functions
<b>Incident response plan (D.4.1)</b>	
CBS security capabilities	Description of security capabilities Test procedure for security capabilities Information supporting incident response and recovery plans
CBS documentation	Design description Ship cyber resilience test procedure
Vessel design documentation	Incident response plans
Ship cyber security and resilience program	



<b>Local, independent and/or manual operation (D.4.2)</b>	
CBS security capabilities	
CBS documentation	Description of security capabilities Test procedure for security capabilities Information supporting incident response and recovery plans
Vessel design documentation	Design description Ship cyber resilience test procedure
Ship cyber security and resilience program	Incident response plans
<b>Network isolation (D.4.3)</b>	
CBS security capabilities	
CBS documentation	Description of security capabilities Test procedure for security capabilities Information supporting incident response and recovery plans
Vessel design documentation	Design description Ship cyber resilience test procedure
Ship cyber security and resilience program	Incident response plans
<b>Fallback to a minimal risk condition (section D.4.4)</b>	
CBS security capabilities	Deterministic output (#20)
CBS documentation	Description of security capabilities Test procedure for security capabilities Information supporting incident response and recovery plans
Vessel design documentation	Design description Ship cyber resilience test procedure
Ship cyber security and resilience program	Incident response plans

<b>Recovery plan (D.5.1)</b>	
CBS security capabilities	
CBS documentation	Description of security capabilities Test procedure for security capabilities Information supporting incident response and recovery plans
Vessel design documentation	Design description Ship cyber resilience test procedure
Ship cyber security and resilience program	Recovery plans
	Section 25 (C.1.3) Section 25 (C.1.4) Section 25 (C.1.8) (D.5.1.4.1) (D.5.1.4.4) (D.5.1.4.4)

<b>Backup and restore capability (D.5.2)</b>	
CBS security capabilities	System backup (#26) System recovery and reconstitution (#27)
CBS documentation	Description of security capabilities Test procedure for security capabilities Information supporting incident response and recovery plans
Vessel design documentation	Ship cyber resilience test procedure
Ship cyber security and resilience program	Recovery plan
	Section 25 (D.1) Section 25 (C.1.3) Section 25 (C.1.4) Section 25 (C.1.8) (4.5.2.4.3) (D.5.1.4.4)

<b>Controlled shutdown, reset, restore and restart (D.5.3)</b>	
CBS security capabilities	System recovery and reconstitution (#27)
CBS documentation	Description of security capabilities Test procedure for security capabilities Information supporting incident response and recovery plans
Vessel design documentation	Design description Ship cyber resilience test procedure
Ship cyber security and resilience program	Recovery plans
	Section 25 (D.1) Section 25 (C.1.3) Section 25 (C.1.4) Section 25 (C.1.8) (D.5.3.4.1) (D.5.3.4.3) (D.5.1.4.4)

<b>Risk assessment for exclusion of CBS from the application of requirements (F)</b>	
CBS security capabilities	
CBS documentation	
Vessel design documentation	<b>Risk assessment for the exclusion of CBSs</b>
Ship cyber security and resilience program	<b>(E.1.4)</b>

*This page intentionally left blank*

## Section 25 Cyber Resilience of On-board Systems and Equipment

A.	General . . . . .	25-1
B.	Security Philosophy . . . . .	25-4
C.	Documentation . . . . .	25-5
D.	System Requirements . . . . .	25-7
E.	Secure Development Lifecycle Requirements . . . . .	25-12
F.	Demonstration of compliance . . . . .	25-14

### A. General

#### 1. Introduction

Technological evolution of vessels, ports, container terminals, etc. and increased reliance upon Operational Technology (OT) and Information Technology (IT) has created an increased possibility of cyber-attacks to affect business, personnel data, human safety, the safety of the ship, and also possibly threaten the marine environment. Safeguarding shipping from current and emerging threats must involve a range of controls that are continually evolving which would require incorporating security features in the equipment and systems at design and manufacturing stage. It is therefore necessary to establish a common set of minimum requirements to deliver systems and equipment that can be described as cyber resilient.

This section specifies unified requirements for cyber resilience of on-board systems and equipment.

#### 2. Limitations

This Section does not cover environmental performance for the system hardware and the functionality of the software. In addition to this Section, following Rules shall be applied:

- [Guidance for The Approval and Type Approval of Materials and Equipment for Marine Use \(Pt.1, Vol.W\)](#) for environmental performance for the system hardware
- [Section 10](#) of this Rules for safety of equipment for the functionality of the software

#### 3. Scope

The requirements specified in this Section are applicable to computer based systems as defined in [Section 24](#) for the following vessel.

#### Mandatory requirements for

- 1) Passenger ships (including passenger high-speed craft) engaged in international voyages
- 2) Cargo ships of 500 GT and upwards engaged in international voyages
- 3) High speed craft of 500 GT and upwards engaged in international voyage
- 4) Mobile offshore drilling units of 500 GT and upwards
- 5) Self-propelled mobile offshore units engaged in construction (ie wind turbine installation maintenance and repair, crane units, drilling tenders, accommodation, etc)

### Non-mandatory guidance to

- 1) Ships of war and troopships
- 2) Cargo ships less than 500 gross tonnage
- 3) Vessels not propelled by mechanical means
- 4) Wooden ships of primitive build
- 5) Passenger yachts (passengers not more than 12).
- 6) Pleasure yachts not engaged in trade
- 7) Fishing vessels
- 8) Site specific offshore installations (i.e. FPSOs, FSUs, etc)

For navigation and radiocommunication systems, the application of IEC 61162-460 or other equivalent standards in lieu of the required security capabilities in D may be accepted by BKI, on the condition that requirements in Section 24 are complied with.

#### 3.1 Information and Communication Technology (ICT)

Attention is made to additional requirements on Computer Based Systems and Cyber Resilience as follows:

- Section 10 “Computer Systems” includes requirements for design, construction, commissioning and maintenance of computer-based systems where they depend on software for the proper achievement of their functions. The requirements in Section 10 focus on the functionality of the software and on the hardware supporting the software which provide control, alarm, monitoring, safety or internal communication functions subject to classification requirements.
- Section 24 “Cyber resilience of Ships” includes requirements for cyber resilience of ships, with the purpose of providing technical means to stakeholders which would lead to cyber resilient ships.
- Guidance for Marine Industry (Pt.1, Vol.AC) Sec.9 R-166 on Cyber Resilience: non-mandatory recommended technical requirements that stakeholders may reference and apply to assist with the delivery of cyber resilient ships, whose resilience can be maintained throughout their service life.

#### 4. Definitions & Abbreviations

**Attack surface:** The set of all possible points where an unauthorized user can access a system and extract data. The attack surface comprises two categories: digital and physical. The digital attack surface encompasses all the hardware and software that connect to an organization’s network. These include applications, code, ports, servers and websites. The physical attack surface comprises all endpoint devices that an attacker can gain physical access to, such as desktop computers, hard drives, laptops, mobile phones, removable drives and carelessly discarded hardware.

**Authentication:** Provision of assurance that a claimed characteristic of an identity is correct.

**Compensating countermeasure:** An alternate solution to a countermeasure employed in lieu of or in addition to inherent security capabilities to satisfy one or more security requirements.

**Computer Based System (CBS):** A programmable electronic device, or interoperable set of programmable electronic devices, organized to achieve one or more specified purposes such as collection, processing, maintenance, use, sharing, dissemination, or disposition of information. CBS on-board include IT and OT systems. A CBS may be a combination of subsystems connected via network. On-board CBS may be connected directly or via public means of communications (e.g. Internet) to ashore CBSs, other vessels’ CBS and/or other facilities.

**Computer Network:** A group of two or more computer systems linked together.

**Control:** Means of managing risk, including policies, procedures, guidelines, practices or organizational structures, which can be administrative, technical, management, or legal in nature.

**Cyberattack:** Any type of offensive cyber manoeuvre that targets IT and OT systems, computer networks, and/or personal computer devices and attempts to compromise, destroy or access company and ship systems and data.

**Cyber incident:** An event resulting from any offensive cyber manoeuvre, either intentional or unintentional, that targets or affects one or more CBS onboard, which actually or potentially results in adverse consequences to an onboard system, network and computer or the information that they process, store or transmit, and which may require a response action to mitigate the consequences. Cyber incidents include unauthorized access, misuse, modification, destruction or improper disclosure of the information generated, archived or used in onboard CBS or transported in the networks connecting such systems. Cyber incidents do not include system failures.

**Cyber resilience:** The capability to reduce the occurrence and mitigating the effects of incidents arising from the disruption or impairment of operational technology (OT) used for the safe operation of a ship, which potentially lead to dangerous situations for human safety, safety of the vessel and/or threat to the environment.

**Defence in depth:** Information Security strategy integrating people, technology, and operations capabilities to establish variable barriers across multiple layers and missions of the organization.

**Essential Systems:** Computer Based System contributing to the provision of services essential for propulsion and steering, and safety of the ship. Essential services comprise "Primary Essential Services" and "Secondary Essential Services": Primary Essential Services are those services which need to be in continuous operation to maintain propulsion and steering; Secondary Essential Services are those services which need not necessarily be in continuous operation to maintain propulsion and steering but which are necessary for maintaining the vessel's safety.

**Firewall:** A logical or physical barrier that monitors and controls incoming and outgoing network traffic controlled via predefined rules.

**Firmware:** Software embedded in electronic devices that provide control, monitoring and data manipulation of engineered products and systems. These are normally self-contained and not accessible to user manipulation.

**Hardening:** Hardening is the practice of reducing a system's vulnerability by reducing its attack surface.

**Information Technology (IT):** Devices, software and associated networking focusing on the use of data as information, as opposed to Operational Technology (OT).

**Integrated system:** System combining a number of interacting sub-system and/or equipment organized to achieve one or more specified purposes.

**Network switch (Switch):** A device that connects devices together on a computer network, by using packet switching to receive, process and forward data to the destination device.

**Offensive cyber manoeuvre:** Actions that result in denial, degradation, disruption, destruction, or manipulation of OT or IT systems.

**Operational technology (OT):** Devices, sensors, software and associated networking that monitor and control onboard systems. Operational technology systems may be thought of as focusing on the use of data to control or monitor physical processes.

**OT system:** Computer based systems, which provide control, alarm, monitoring, safety or internal communication functions.

**Patches:** Software designed to update installed software or supporting data to address security vulnerabilities and other bugs or improve operating systems or applications

**Protocols:** A common set of rules and signals that computers on the network use to communicate. Protocols allow to perform data communication, network management and security. Onboard networks usually implement protocols based on TCP/IP stacks or various field buses.

**Recovery:** Develop and implement the appropriate activities to maintain plans for resilience and to restore any capabilities or services that were impaired due to a cyber security event. The Recovery function support s timely return to normal operations to reduce the impact from a cyber security event.

**System:** Combination of interacting programmable devices and/or sub-systems organized to achieve one or more specified purposes

**System Categories (I, II, III):** System categories based on their effects on system functionality, which are defined in [Section 10](#).

**System Integrator:** The specific person or organization responsible for the integration of systems and products provided by suppliers into the system invoked by the requirements in the ship specifications and for providing the integrated system. The system integrator may also be responsible for integration of systems in the ship. This role shall be taken by the Shipyard unless an alternative organization is specifically contracted/assigned this responsibility.

**Untrusted network:** Any network outside the scope of applicability of this Section.

## B. Security Philosophy

### 1. Systems and Equipment

**1.1** A System can consist of group of hardware and software enabling safe, secure and reliable operation of a process. Typical example could be Engine control system, DP system, etc.

**1.2** An Equipment may be one of the following:

- Network devices (i.e. routers, managed switches)
- Security devices (i.e. firewall, Intrusion Prevention System)
- Computers (i.e. workstation, servers)
- Automation devices (i.e. Programmable Logic Controllers)
- Virtual machine cloud-hosted

### 2. Cyber Resilience

The cyber resilience requirements in [D](#). will be applicable for all systems in scope of [Section 24](#) as applicable. Additional requirements related to interface with untrusted networks will only apply for systems where such connectivity is designed.

### 3. Essential Systems Availability

**3.1** Security measures for Essential system shall not adversely affect the systems availability.

**3.2** Implementation of security measures shall not cause loss of safety functions , loss of control functions, loss of monitoring functions or loss of other functions which could result in health, safety and environmental consequences.

**3.3** The system shall be adequately designed to allow the ship to continue its mission critical operations in a manner that ensures the confidentiality, integrity, and availability of the data necessary for safety of the vessel, its systems, personnel and cargo.



#### 4. Compensating Countermeasures

4.1 Compensating countermeasure may be employed in lieu of or in addition to inherent security capabilities to satisfy one or more security requirements.

Compensating countermeasure(s) shall meet the intent and rigor of the original stated requirement considering the referenced standards as well as the differences between each requirement and the related items in the standards, and follow the principles specified in section 3.1.3.

### C. Documentation

#### 1. CBS Documentation

The following documents shall be submitted to BKI for review and approval in accordance with the requirements in this Section. See also F.2..

##### 1.1 CBS asset inventory

The CBS asset inventory shall include the information below.

- List of hardware components (e.g., host devices, embedded devices, network devices)Name
- Brand/manufacturer
- Model/type
- Short description of functionality/purpose
- Physical interfaces (e.g., network, serial)
- Name/type of system software (e.g., operating system, firmware)
- Version and patch level of system software
- Supported communication protocols

List of software components (e.g., application software, utility software)

- The hardware component where it is installed
- Brand/manufacturer
- Model/type
- Short description of functionality/purpose
- Version of software

##### 1.2 Topology diagrams

The physical topology diagram shall illustrate the physical architecture of the system. It shall be possible to identify the hardware components in the CBS asset inventory. The diagram shall illustrate the following:

- All endpoints and network devices, including identification of redundant units
- Communication cables (networks, serial links), including communication with I/O units
- Communication cables to other networks or systems

The logical topology diagram shall illustrate the data flow between components in the system. The diagram shall illustrate the following:

- Communication endpoints (e.g. workstations, controllers, servers)
- Network devices (switches, routers, firewalls)
- Physical and virtual computers
- Physical and virtual communication paths
- Communication protocols

One combined topology diagram may be acceptable if all requested information can be clearly illustrated.

### 1.3 Description of security capabilities

This document shall describe how the CBS with its hardware and software components meets the required security capabilities in [D.1.](#).

Any network interfaces to other CBSs in the scope of applicability of ?? shall be described. The description shall include destination CBS, data flows, and communication protocols. If the System integrator has allocated the destination CBS to another security zone, components providing protection of the security zone boundary (see [Section 24.D.2.2.1](#)) shall be described in detail if delivered as part of the CBS.

Any network interfaces to other systems or networks outside the scope of applicability of [Section 24](#) (untrusted networks) shall be described. The description shall specify compliance with the additional security capabilities in [section 4.2](#), and include relevant procedures or instructions for the crew. Components providing protection of the security zone boundary (see [Section 24.D.2.2.1](#)) shall be described in detail if delivered as part of the CBS.

A separate chapter shall be designated for each requirement. All hardware and software components in the system shall be addressed in the description, as relevant.

If any requirement is not fully met, this shall be specified in the description, and compensating countermeasures shall be proposed. The compensating countermeasures should:

- Protect against the same threats as the original requirement
- Provide an equal level of protection as the original requirement
- Not be a security control that is required by other requirements in this Section
- Not introduce higher security risk

Any supporting documents (e.g. OEM information) necessary to verify compliance with the requirements shall be referenced in the description and submitted.

### 1.4 Test procedure of security capabilities

This document shall describe how to demonstrate by testing that the system complies with the requirements in [D.1.](#) and [D.2.](#), including any compensating countermeasures. Demonstration of compliance by analytic evaluation may be specially considered. The procedure shall include a separate chapter for each applicable requirement and describe:

- Necessary test setup (i.e. to ensure the test can be repeated with the same expected result)
- Test equipment
- Initial condition(s)
- Test methodology, detailed test steps
- Expected results and acceptance criteria

The procedure shall also include means to update test results and record findings during the testing.

### 1.5 Security configuration guidelines

This document shall describe recommended configuration settings of the security capabilities and specify default values. The objective is to ensure the security capabilities are implemented in accordance with UR E26 and any specifications by the System integrator (e.g. user accounts, authorisation, password policies, safe state of machinery, firewall rules, etc.)

The document shall serve as basis for verification of item no.29 in [D.1.](#).

### 1.6 Secure development lifecycle documents

This documentation shall be submitted to BKI upon request and shall describe the supplier's processes and controls in accordance with requirements for secure development lifecycle in [E.](#). Software updates and patching shall be described. The document shall prepare BKI for survey as per [F.3.4.](#)

### 1.7 Plans for maintenance and verification of the CBS

This document shall be submitted to BKI upon request and shall include procedures for security-related maintenance and testing of the system. The document shall include instructions for how the user can verify correct operation of the system's security functions as required by item no.19 in [D.1.](#).

### 1.8 Information supporting the owner's incident response and recovery plan

This document shall be submitted to BKI upon request and shall include procedures or instructions allowing the user to accomplish the following:

- Local independent control (see [Section 24.D.4.2](#))
- Network isolation (see [Section 24.D.4.3](#))
- Forensics by use of audit records (see [D.1.](#) item no.13)
- Deterministic output (see [Section 24.D.4.4](#) and [D.1.](#) item no. 20)
- Backup (see [D.1.](#) item no. 26)
- Restore (see [D.1.](#) item no. 27)
- Controlled shutdown, reset, roll-back and restart (see [Section 26.D.5.3](#))

### 1.9 Management of change plan

This document shall be submitted to BKI upon request. It is expected that this procedure is not specific for cyber security and is also required by [Section 10.](#)

### 1.10 Test reports

CBSs with Type approval certificate covering the security capabilities of this Section may be exempted from survey by BKI. However, test reports signed by the supplier shall be submitted to BKI, demonstrating that the supplier has completed design, construction, testing, configuration, and hardening as would otherwise be verified by BKI in survey (??).

## D. System Requirements

This sub-section specifies the required security capabilities for CBSs in the scope specified in [A.3.](#)

**The requirements in this section are based on the selected requirements in IEC 62443-3-3. To determine the full content, rationale and relevant guidance for each requirement, the reader should consult the referenced standard.**

### 1. Required security capabilities

The following security capabilities are required for all CBSs in the scope specified in [A.3](#).

**Table 25.1: Required Capabilities**

No.	Objective	Requirements
<b>Protect against casual or coincidental access by unauthenticated entities</b>		
1	Human user identification and authentication	The CBS shall identify and authenticate all human users who can access the system directly or through interfaces (IEC 62443-3-3/SR 1.1)
2	Account management	The CBS shall provide the capability to support the management of all accounts by authorized users, including adding, activating, modifying, disabling and removing account (IEC 62443-3-3/SR 1.3)
3	Identifier management	The CBS shall provide the capability to support the management of identifiers by user, group and role. (IEC 62443-3-3/SR 1.4)
4	Authenticator management	The CBS shall provide the capability to: <ul style="list-style-type: none"> <li>- Initialize authenticator content</li> <li>- Change all default authenticators upon control system installation</li> <li>- Change/refresh all authenticators</li> <li>- Protect all authenticators from unauthorized disclosure and modification when stored and transmitted.</li> </ul> (IEC 62443-3-3/SR 1.5)
5	Wireless access management	The CBS shall provide the capability to identify and authenticate all users (humans, software processes or devices) engaged in wireless communication (IEC 62443-3-3/SR 1.6)
6	Strength of password-based authentication	The CBS shall provide the capability to enforce configurable password strength based on minimum length and variety of character types. (IEC 62443-3-3/SR 1.7)
7	Authenticator feedback	The CBS shall obscure feedback during the authentication process. (IEC 62443-3-3/SR 1.10)
<b>Protect against casual or coincidental misuse</b>		
8	Authorization enforcement	On all interfaces, human users shall be assigned authorizations in accordance with the principles of segregation of duties and least privilege. (IEC 62443-3-3/SR 2.1)
9	Wireless use control	The CBS shall provide the capability to authorize, monitor and enforce usage restrictions for wireless connectivity to the system according to commonly accepted security industry practices. (IEC 62443-3-3/SR 2.2)
10	Use control for portable and mobile devices	When the CBS supports use of portable and mobile devices, the system shall include the capability to <ol style="list-style-type: none"> <li>a) Limit the use of portable and mobile devices only to those permitted by design</li> <li>b) Restrict code and data transfer to/from portable and mobile devices</li> </ol> Note: Port limits / blockers (and silicone) could be accepted for a specific system (IEC 62443-3-3/SR 2.3)
11	Mobile code	The CBS shall control the use of mobile code such as java scripts, ActiveX and PDF. (IEC 62443-3-3/SR 2.4)
12	Session lock	The CBS shall be able to prevent further access after a configurable time of inactivity or following activation of manual session lock. (IEC 62443-3-3/SR 2.5)

**Table 25.1: Required Capabilities (continued)**

SI No	Objective	Requirements
13	Auditable events	The CBS shall generate audit records relevant to security for at least the following events: access control, operating system events, backup and restore events, configuration changes, loss of communication. (IEC 62443-3-3/SR 2.8)
14	Audit storage capacity	The CBS shall provide the capability to allocate audit record storage capacity according to commonly recognized recommendations for log management. Auditing mechanisms shall be implemented to reduce the likelihood of such capacity being exceeded. (IEC 62443-3-3/SR 2.9)
15	Response to audit processing failures	The CBS shall provide the capability to prevent loss of essential services and functions in the event of an audit processing failure. (IEC 62443-3-3/SR 2.10)
16	Timestamps	The CBS shall timestamp audit records. (IEC 62443-3-3/SR 2.11)
<b>Protect the integrity of the CBS against casual or coincidental manipulation</b>		
17	Communication integrity	The CBS shall protect the integrity of transmitted information. Note: Cryptographic mechanisms shall be employed for wireless networks. (IEC 62443-3-3/SR 3.1)
18	Malicious code protection	The CBS shall provide capability to implement suitable protection measures to prevent, detect and mitigate the effects due to malicious code or unauthorized software. It shall have the feature for updating the protection mechanisms (IEC 62443-3-3/SR 3.2)
19	Security functionality verification	The CBS shall provide the capability to support verification of the intended operation of security functions and report when anomalies occur during maintenance (IEC 62443-3-3/SR 3.3)
20	Deterministic output	The CBS shall provide the capability to set outputs to a predetermined state if normal operation cannot be maintained as a result of an attack. The predetermined state could be: - Unpowered state - Last-known value - Fixed value (IEC 62443-3-3/SR 3.6)
<b>Prevent the unauthorized disclosure of information via eavesdropping or casual exposure</b>		
21	Information confidentiality	The CBS shall provide the capability to protect the confidentiality of information for which explicit read authorization is supported, whether at rest or in transit. Note: For wireless network, cryptographic mechanisms shall be employed to protect confidentiality of all information in transit. (IEC 62443-3-3/SR 4.1)
22	Use of cryptography	If cryptography is used, the CBS shall use cryptographic algorithms, key sizes and mechanisms according to commonly accepted security industry practices and recommendations. (IEC 62443-3-3/SR 4.3)
<b>Monitor the operation of the CBS and respond to incidents</b>		
23	Audit log accessibility	The CBS shall provide the capability for accessing audit logs on read only basis by authorized humans and/or tools. (IEC 62443-3-3/SR 6.1)

**Table 25.1: Required Capabilities (continued)**

SI No	Objective	Requirements
<b>Ensure that the control system operates reliably under normal production conditions</b>		
24	Denial of service protection	The CBS shall provide the minimum capability to maintain essential functions during DoS events. <b>Note: It is acceptable that the CBS may operate in a degraded mode upon DoS events, but it shall not fail in a manner which may cause hazardous situations. Overload-based DoS events should be considered, i.e. where the networks capacity is attempted flooded, and where the resources of a computer is attempted consumed.</b> (IEC 62443-3-3/SR 7.1)
25	Resource management	The CBS shall provide the capability to limit the use of resources by security functions to prevent resource exhaustion. (IEC 62443-3-3/SR 7.2)
26	System backup	The identity and location of critical files and the ability to conduct backups of user-level and system-level information (including system state information) shall be supported by the CBS without affecting normal operations (IEC 62443-3-3/SR 7.3)
27	System recovery and reconstitution	The CBS shall provide the capability to be recovered and reconstituted to a known secure state after a disruption or failure. (IEC 62443-3-3/SR 7.4)
28	Alternative power source	The control system shall provide the capability to switch to and from an emergency power supply without affecting the existing security state or a documented degraded mode. (IEC 62443-3-3/SR 7.5)
29	Network and security configuration settings	The CBS traffic shall provide the capability to be configured according to recommended network and security configurations as described in guidelines provided by the control system supplier. The CBS shall provide an interface to the currently deployed network and security configuration settings. (IEC 62443-3-3/SR 7.6)
30	Least Functionality	The installation, the availability and the access rights of the following shall be limited to the strict needs of the functions provided by the CBS: - operating systems software components, processes and services - network services, ports, protocols, routes and hosts accesses and any software (IEC 62443-3-3/SR 7.7)

## 2. Additional security capabilities

The following additional security capabilities are required for CBSs with network communication to untrusted networks (i.e. interface to any networks outside the scope of [Section 24](#)).

CBSs with communication traversing the boundaries of security zones shall also meet requirements for network segmentation and zone boundary protection in [Section 24.D.2.1](#) and [Section 24.D.2.2](#).

**Table 25.2: Additional capabilities**

No	Objective	Requirements
31	Multifactor authentication for human users	Multifactor authentication is required for human users when accessing the CBS from or via an untrusted network. (IEC 62443-3-3/SR 1.1, RE 2)
32	Software process and device identification and authentication	The system shall identify and authenticate software processes and devices (IEC 62443-3-3/SR 1.2)
33	Unsuccessful login attempts	The CBS shall enforce a limit of consecutive invalid login attempts from untrusted networks during a specified time period. (IEC 62443-3-3/SR 1.11)
34	System use notification	The CBS shall provide the capability to display a system use notification message before authenticating. The system use notification message shall be configurable by authorized personnel. (IEC 62443-3-3/SR 1.12)
35	Access via Untrusted Networks	Any access to the CBS from or via untrusted networks shall be monitored and controlled. (IEC 62443-3-3/SR 1.13)
36	Explicit access request approval	The CBS shall deny access from or via untrusted networks unless explicitly approved by authorized personnel on board. (IEC 62443-3-3/SR 1.13, RE1)
37	Remote session termination	The CBS shall provide the capability to terminate a remote session either automatically after a configurable time period of inactivity or manually by the user who initiated the session. (IEC 62443-3-3/SR 2.6)
38	Cryptographic integrity protection	The CBS shall employ cryptographic mechanisms to recognize changes to information during communication with or via untrusted networks. (IEC 62443-3-3/SR 3.1, RE1)
39	<b>Input validation</b>	<b>The CBS shall validate the syntax, length and content of any input data via untrusted networks that is used as process control input or input that directly impacts the action of the CBS. (IEC 62443-3-3/SR 3.5)</b>
40	Session integrity	The CBS shall protect the integrity of sessions. Invalid session IDs shall be rejected. (IEC 62443-3-3/SR 3.8)
41	Invalidation of session IDs after session termination	The system shall invalidate session IDs upon user logout or other session termination (including browser sessions). (IEC 62443-3-3/SR 3.8, RE1)

### E. Secure Development Lifecycle Requirements

A Secure Development Lifecycle (SDLC) broadly addressing security aspects in following stages shall be followed for the development of systems or equipment

- Requirement analysis phase
- Design phase
- Implementation phase
- Verification phase



- Release phase
- Maintenance Phase
- End of life phase

A document, shall be produced that records how the security aspects have been addressed in above phases and shall at minimum integrate controlled processes as set out in below E.2. to E.7.. The said document is required to be submitted to class for review and approval.

1. (IEC 62443-4-1/SM-8) The manufacturer shall have procedural and technical controls in place to protect private keys used for code signing from unauthorized access or modification. The manufacturer shall have QA process to test the updates before releasing
2. (IEC 62443-4-1/SUM-2) A process shall be employed to ensure that documentation about product security updates is made available to users (which could be through establishing a cyber security point of contact or periodic publication which can be accessed by the user) that includes but is not limited to:
  - 1) The product version number(s) to which the security patch applies;
  - 2) Instructions on how to apply approved patches manually and via an automated process;
  - 3) Description of any impacts that applying the patch to the product can have, including reboot;
  - 4) Instructions on how to verify that an approved patch has been applied; and
  - 5) Risks of not applying the patch and mediations that can be used for patches that are not approved or deployed by the asset owner.
3. (IEC 62443-4-1/SUM-3) A process shall be employed to ensure that documentation about dependent component or operating system security updates is available to users that includes but is not limited to:
  - 1) Stating whether the product is compatible with the dependent component or operating system security update;
4. (IEC 62443-4-1/SUM-4) A process shall be employed to ensure that security updates for all supported products and product versions are made available to product users in a manner that facilitates verification that the security patch is authentic.
5. (IEC 62443-4-1/SG-1) A process shall exist to create product documentation that describes the security defence in depth strategy for the product to support installation, operation and maintenance that includes:
  - 1) Security capabilities implemented by the product and their role in the defence in depth strategy;
  - 2) Threats addressed by the defence in depth strategy; and
  - 3) Product user mitigation strategies for known security risks associated with the product, including risks associated with legacy code.
6. (IEC 62443-4-1/SG-2) A process shall be employed to create product user documentation that describes the security defence in depth measures expected to be provided by the external environment in which the product is to be used.

7. (IEC 62443-4-1/SG-3) A process shall be employed to create product user documentation that includes guidelines for hardening the product when installing and maintaining the product. The guidelines shall include, but are not limited to, instructions, rationale and recommendations for the following:

- 1) Integration of the product, including third-party components, with its product security context
- 2) Integration of the product's application programming interfaces/protocols with user applications;
- 3) Applying and maintaining the product's defence in depth strategy
- 4) Configuration and use of security options/capabilities in support of local security policies, and for each security option/capability:
  - its contribution to the product's defence in depth strategy
  - descriptions of configurable and default values that include how each affects security along with any potential impact each has on work practices; and
  - setting/changing/deleting its value;
- 5) Instructions and recommendations for the use of all security-related tools and utilities that support administration, monitoring, incident handling and evaluation of the security of the product;
- 6) Instructions and recommendations for periodic security maintenance activities;
- 7) Instructions for reporting security incidents for the product to the product supplier;
- 8) Description of the security best practices for maintenance and administration of the product.

## F. Demonstration of compliance

### 1. Introduction

Suppliers shall in cooperation with the System integrator determine if this Section is mandatory for the CBS, see [Figure .25.1](#).

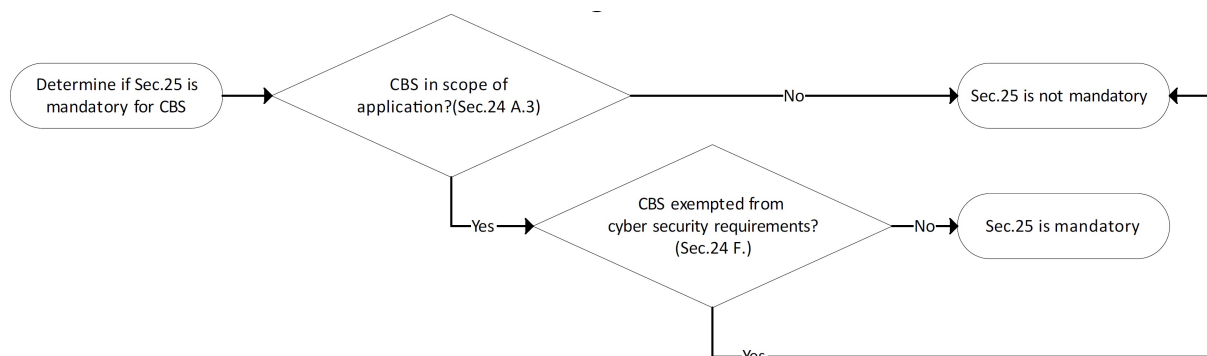
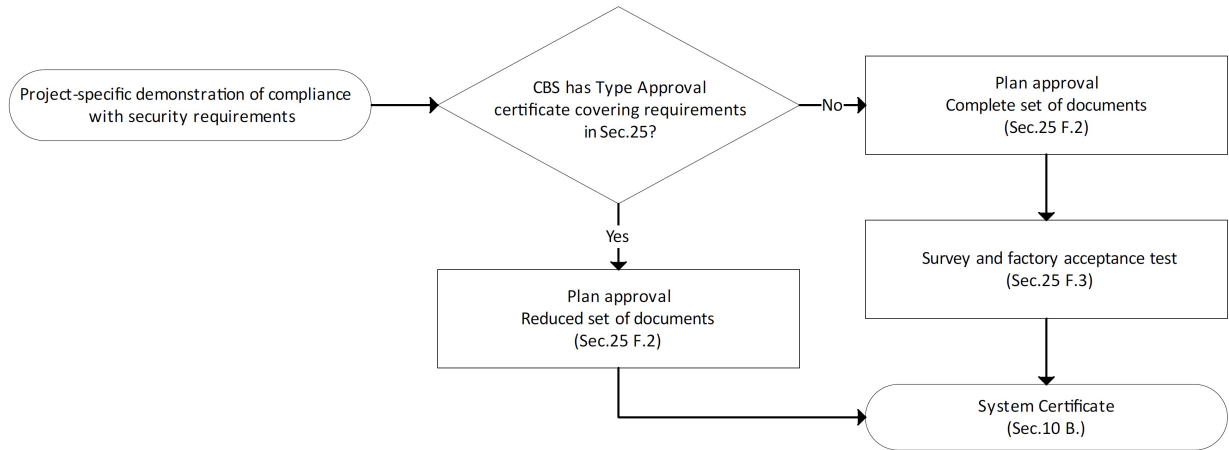

Figure 25.1:

Compliance with security requirements shall be demonstrated as indicated in [Figure .25.2](#). This classification process is ship-specific and shall result in a System certificate.



**Figure 25.2:**

Type approval is voluntary and applies for CBSs that are standard and routinely manufactured. See [Section 10](#) for definition of System certification and Type approval.

The process in [Figure .25.1](#) and [Figure .25.2](#) applies also if other equivalent standards are applied for navigation and radiocommunication equipment (see [A.3.](#)). In such case:

- the process in [Figure .25.1](#) illustrates if the equivalent standard is mandatory (in lieu of this Section)
- the process in [Figure .25.2](#) illustrates that the certification process is lessened if the CBS has been type approved in accordance with the equivalent standard.

## 2. Plan approval

Plan approval is assessment of documents of a CBS intended for a specific vessel. The documents in [C.](#) are required to be submitted by the supplier. The documents shall enable BKI to verify compliance with requirements in this Section.

If the CBS holds a valid Type approval certificate covering the requirements of this Section, subject to approval by BKI, the supplier may submit a reduced set of vessel-specific documents to BKI (see [Table 25.3](#)).

The approved version of the documents shall be included in the delivery of the CBS to the system integrator.

## 3. Survey and factory acceptance test

Survey and factory acceptance testing (FAT) is a vessel-specific verification activity required for CBSs that do not hold a valid Type approval certificate covering the requirements of this Section.

The objective of the survey and FAT is to demonstrate by testing and/or analytic evaluation that the CBS complies with applicable requirements in this Section. The survey and FAT shall be carried out at the supplier’s premises or at other works having the adequate apparatus for testing and inspection.

After completed plan approval and survey/FAT, BKI will issue a System certificate that shall accompany the CBS upon delivery to the system integrator.

The following subsections specify the survey and FAT activities.

### 3.1 General survey items

The supplier shall demonstrate that design, construction, and internal testing has been completed.

It shall also be demonstrated that the system to be delivered is correctly represented by the approved documentation. This shall be done by inspecting the system and comparing the components and arrangement/architecture with the asset inventory ([C.1.1](#)) and the topology diagrams ([C.1.2](#)).

### 3.2 Test of security capabilities

The supplier shall test the required security capabilities on the system to be delivered. The tests shall be carried out in accordance with the approved test procedure in C.1.4 and be witnessed/accepted by the class surveyor.

The tests shall provide the class surveyor with reasonable assurance that all requirements are met. This implies that testing of identical components is normally not required.

### 3.3 Correct configuration of security capabilities

The supplier shall test/demonstrate for the class surveyor that security settings in the system's components have been configured in accordance with the configuration guidelines in C.1.5. This demonstration may be carried out in conjunction with testing of the security capabilities.

The security settings shall be documented in a report, e.g. a ship-specific instance of the configuration guidelines.

### 3.4 Secure development lifecycle

The supplier shall, in accordance with documentation in C.1.6, demonstrate compliance with requirements for secure development lifecycle in E..

#### 3.4.1 Controls for private keys (IEC 62443-4-1/SM-8)

This requirement applies if the system includes software that is digitally signed for the purpose of enabling the user to verify its authenticity.

The supplier shall present management system documentation substantiating that policies, procedures and technical controls are in place to protect generation, storage and use of private keys used for code signing from unauthorized access.

The policies and procedures shall address roles, responsibilities and work processes. The technical controls shall include e.g. physical access restrictions and cryptographic hardware (e.g. Hardware security module) for storage of the private key.

#### 3.4.2 Security update documentation (IEC 62443-4-1/SUM-2)

The supplier shall present management system documentation substantiating that a process is established in the organization to ensure security updates are informed to the users. The information to the users shall include the items listed in E.2..

#### 3.4.3 Dependent component security update documentation (IEC 62443-4-1/SUM-3)

The supplier shall present management system documentation, as required by E.3., substantiating that a process is established in the organization to ensure users are informed whether the system is compatible with updated versions of acquired software in the system (new versions/patches of operating system or firmware). The information shall address how to manage risks related to not applying the updated acquired software.

#### 3.4.4 Security update delivery (IEC 62443-4-1/SUM-4)

The supplier shall present management system documentation, as required by E.4., substantiating that a process is established in the organization ensuring that system security updates are made available to users, and describing how the user may verify the authenticity of the updated software.

#### **3.4.5 Product defence in depth (IEC 62443-4-1/SG-1)**

The supplier shall present management system documentation, as required by [E.5.](#), substantiating that a process is established in the organization to document a strategy for defence-in-depth measures to mitigate security threats to software in the CBS during installation, maintenance and operation.

Examples of threats could be installation of unauthorised software, weaknesses in the patching process, tampering with software in the operational phase of the ship.

#### **3.4.6 Defence in depth measures expected in the environment (IEC 62443-4-1/SG-2)**

The supplier shall present management system documentation, as required by [E.6.](#), substantiating that a process is established in the organization to document defence-in-depth measures expected to be provided by the external environment, such as physical arrangement, policies and procedures.

#### **3.4.7 Security hardening guidelines (IEC 62443-4-1/SG-3)**

The supplier shall present management system documentation, as required by [E.7.](#), substantiating that a process is established in the organization to ensure that hardening guidelines are produced for the system.

The guidelines shall specify how to reduce vulnerabilities in the system by removal/prohibiting /disabling of unnecessary software, accounts, services, etc.

The following table summarizes documents to be submitted by the supplier to BKI.

**Table 25.3:**

Document	Requirements	Class
CBS asset inventory (E27 sec.3.1.1)	To be incorporated in Vessel asset inventory (E26 sec.4.1.1)	Approve <sup>1)</sup> <sup>2)</sup>
Topology diagrams (E27 sec.3.1.2)	Enabling System integrator to design security zones and conduits (E26 sec.4.2.1)	Approve <sup>1)</sup> <sup>2)</sup>
Description of security capabilities (E27 sec.3.1.3)	Required security capabilities (E27 sec.4.1)	Approve <sup>1)</sup>
	Additional security capabilities, if applicable (E27 sec.4.2)	
Test procedure for security capabilities (E27 sec.3.1.4)	Required security capabilities (E27 sec.4.1)	Approve <sup>1)</sup>
	Additional security capabilities, if applicable (E27 sec.4.2)	
Security configuration guidelines (E27 sec.3.1.5)	Network and security configuration settings (E27 sec.4.1 item 29)	Info <sup>1)</sup>
Secure development lifecycle (E27 sec.3.1.6)	SDLC requirements (E27 sec.5)	Approve <sup>1)</sup>
Plans for maintenance and verification (E27 sec.3.1.7)	Security functionality verification (E27 sec.4.1 item 19)	Info <sup>1)</sup>
Information supporting incident response and recovery plans (E27 sec.3.1.8)	Auditable events (E27 sec.4.1 item 13)	Info <sup>1)</sup>
	Deterministic output (E27 sec.4.1 item 20)	Info <sup>1)</sup>
	System backup (E27 sec.4.1 item 26)	Info <sup>1)</sup>
	System recovery and reconstitution (E27 sec.4.1 item 27)	Info <sup>1)</sup>
Management of change plan (E27 sec.3.1.9)	Management of change process (E22)	Info <sup>1)</sup>
Test reports (E27 sec.3.1.10)	Configuration of security capabilities and hardening (E27 sec.3.1.5 and sec.5.7)	Info <sup>1)</sup>
Note 1: Required for CBS without type approved security capabilities		
Note 2: Required for CBS with type approved security capabilities		

# Annex A Additional Requirements for Low Voltage Shore Connection

A.	General . . . . .	A-1
B.	Shore Installation . . . . .	A-4
C.	Ship to Shore Connection and Interface . . . . .	A-5
D.	Ship Installation . . . . .	A-7
E.	Testing and Trials . . . . .	A-10

## A. General

### 1. Scope and application

1.1 The additional class notation SP(LV) is assigned in accordance with this Rules, to ships fitted with low voltage shore connection systems complying with the requirements of this Annex.

For the purpose of this Annex, the term “Shore Connection” means Low Voltage Shore Connection.

1.2 These requirements apply to the design, safety, reliability and availability of shipboard electrical and control engineering arrangements installed to permit operation of services by connection to an external Low Voltage electrical power supply in port. Low Voltage is a set of voltage levels whose upper limit is generally accepted to be 1000 V AC.

1.3 These requirements are applied as complement to other Rules in [Part 1, Seagoing Ships](#) as applicable.

1.4 If necessary, beside of the BKI’s Construction Rules, National Regulations and/or requirements by the Owners or Authorities responsible for shore supply or distribution system are to be observed as well.

### 2. Other standards to be considered

Systems complying with the standards mentioned below can be accepted by BKI in case by case basis

#### 2.1 National standards

Requirements of national standards (SNI) can also be considered

#### 2.2 International Standards

The international standards below can also be considered:

- IEC/IEEE 80005-3 Utility connections in port - Part 3: Low Voltage Shore Connection (LVSC) Systems
- Relevant ISA standards regarding control systems

### 3. General requirements

#### 3.1 System description

3.1.1 A typical shore connection system described in these requirements consists of the following hardware components, see [Fig. A.1](#):

- Shore supply equipment

- Transformer
- Static/ rotating convertor, where applicable (for instance, when the shore and vessel have different frequencies)
- Cables and cables management equipment including plug and socket-outlet
- Shore connection switchboard
- On board transformer, where applicable (for instance when the vessel has a low voltage main switchboard)
- Ship receiving switchboard (in general, a section of the main switchboard).

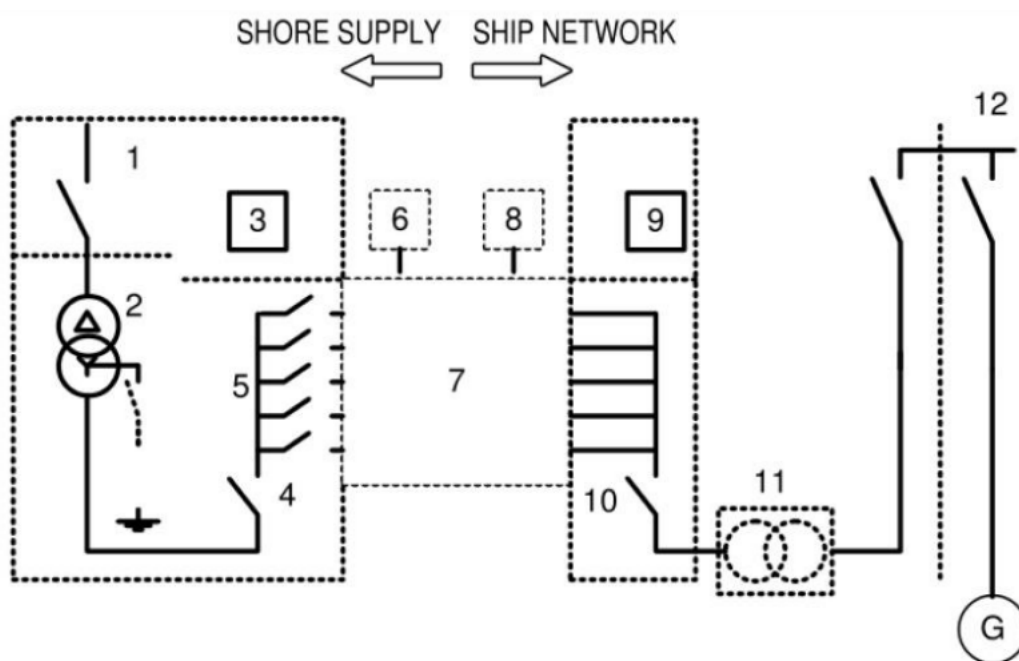

#### Key

- |   |   |
|---|---|
| 1. SHORE SUPPLY SYSTEM  | 8. CONTROL SHIP                               |
| 2. SHORE-SIDE TRANSFORMER AND NEUTRAL GROUNDING RESISTOR OR/AND IT SYSTEM | 9. SHIP PROTECTION RELAYING                   |
| 3. SHORE-SIDE PROTECTION RELAYING   | 10. ON-BOARD SHORE CONNECTION SWITCHBOARD     |
| 4. SHORE-SIDE CIRCUIT-BREAKER   | 11. ON – BOARD TRANSFORMER (WHERE APPLICABLE) |
| 5. SHORE-SIDE FEEDERS CIRCUIT-BREAKERS                                    | 12. ON-BOARD RECEIVING SWITCHBOARD            |
| 6. CONTROL SHORE  |   |
| 7. SHORE-TO-SHIP CONNECTION AND INTERFACE EQUIPMENT                       |   |

**Figure A.1: Block diagram of a typical shore connection system**

## 3.2 Design requirements

**3.2.1** Each failure is to be identified by alarm at a manned control station on board.

**3.2.2** Functions are to be designed on the fail safe principle.

**3.2.3** Suitable warning notices are to be provided at locations along connection equipment routes including at connection locations.

**3.2.4** Effective means are to be provided to prevent accumulation of moisture and condensation, even if equipment are idle for appreciable periods.



**3.2.5** Connection to an external electrical power supply is not to adversely affect the availability of main, auxiliary or emergency machinery, including ship sources of electrical power to allow ship power to be restored.

**3.2.6** Shore connection system is to be compatible with forces, moments and deflections resulting from the movement of the moored ship under normal operational circumstances.

### **3.3 Location and construction**

**3.3.1** LV equipment is to be installed in access controlled spaces.

**3.3.2** Equipment shall be suitable for the environment conditions in the space(s) where it is expected to be operate. Ship equipment is to comply with the applicable requirements of IEC 60092-101.

**3.3.3** The permanent or temporary installation of electrical equipment located in the combined hazardous area envelope of the ship and shore facilities is to be minimized.

**3.3.4** If some of the equipment cannot be located in a non-hazardous area, then it is to be certified of a safe type. See also [Section 1.K](#)

**3.3.5** Shore connection system is to be located outside of areas where it could be damaged by in-port activities or ship activities under normal operational circumstances.

### **3.4 Emergency shut down**

**3.4.1** Fail-safe, hard-wired circuits shall be used for emergency shut-down. This does not preclude emergency shut-down activation commands from non-safety programmable electronic equipment, e.g. programmable protection relays

**3.4.2** The Emergency Shut-Down facilities are to be activated in the event of:

- overtension on the flexible cable (mechanical stress), see [C.1.1.6](#)
- loss of the emergency Shut-Down control circuit
- activation of any emergency-stop buttons
- activation of protection relays provided to detect faults on the LV connection cable or connectors
- withdrawal of power plugs from socket-outlets while LV connections are live (before the necessary degree of protection is no longer achieved or power connections are broken).

**3.4.3** Activation of the emergency shut down shall instantaneously open all circuit breaker on shore and on-board ship

**3.4.4** Emergency stops shall be provided at:

- Ship's manned station during Shore Connection system operation
- In the vicinity of socket outlet or other suitable connections
- Active cable management system control locations
- Shore connection switchboards.

**3.4.5** Additional manual activation facilities may also be provided at other locations where it is considered necessary. The means of activation are to be visible and prominent, prevent inadvertent operation and require a manual action to reset.

**3.4.6** An alarm indicating activation of the Emergency Shut-Down is to be provided at a Ship's manned station during Shore Connection system operation. The alarm shall indicate the cause of the activation.

**3.4.7** Consequences of emergency shutdown activation on the ship installation are to be evaluated.

## B. Shore Installation

### 1. Electrical system

#### 1.1 Capacity

**1.1.1** The rating of the supply system is to be adequate for the normal continuous electrical load of the vessel at quay. In particular, the external supplies are to be sufficiently rated to supply the following services:

**1.1.2** If the propulsion machinery is intended to be used to maintain the vessel at quay in case of heavy weather, the whole shore supply system is to be sized accordingly.

**1.1.3** The maximum electrical step load switched on or off is not to cause the power supply quality to exceed the parameters given in 1.2 or failure when connected to an external electrical power supply in accordance.

#### 1.2 Quality of the shore power supply

**1.2.1** The shore power supply system is to be documented.

**1.2.2** Each ship is to be provided with a dedicated low voltage shore supply installation which is galvanically isolated from other connected ships and the shore power.

**1.2.3** Ship electrical equipment is to be only connected to shore supplies that will be able to maintain the distribution system voltage and frequency characteristics within the limits specified in IEC 60092-101 and indicated in the tables below.

**1.2.4** The voltage and frequency variations of the power supply shown in Table A.1 and Table A.2 are to be assumed.

**Table A.1: Voltage and frequency variation in steady state condition**

Quantity in operation	Parameter	Value
Voltage	Upper voltage limit, for no-load condition	+6% nominal rating
	Lower voltage limit, for rated load condition	-5% nominal rating
Frequency	Frequency variation	±5% nominal rating

**Table A.2: Voltage and frequency variation in transient condition**

Quantity in operation	Parameter	Value
Voltage	Voltage variation	+20%, -15%
Frequency	Frequency variation	±10%

**1.2.5** It is assumed that the voltage harmonic distortion does not exceed the values given in Table A.3.

**Table A.3: Voltage and frequency variation in transient condition**

Parameter	Value
Individual voltage harmonic distortion	3%
Total voltage harmonic distortion	5%

## 2. Electrical protection

### 2.1 Earthing

2.1.1 The neutral point treatment on the shore supply must be able to adapt to various grounding philosophies.

2.1.2 The vessel's earth fault protection system is not to be impaired or disabled by the system earthing arrangement of the shore supply.

2.1.3 The vessel is not to be permitted to establish shore power connection with an earth fault present on either side.

### 2.2 Protection of circuit

2.2.1 The whole shore power installation is to be at least protected against overcurrent, short circuit and earth fault.

2.2.2 LV circuit-breaker on the secondary side of the transformer is to be arranged to open all insulated poles in the event of the following conditions:

- Overload
- Instantaneous overcurrent
- Overcurrent
- Undervoltage
- Overvoltage
- Reverse power
- Earth fault.

## 3. Shore connection converter equipment

### 3.1 General

3.1.1 Where provided, ship-converting equipment (transformers and/or semiconductor converters) for connecting HV-shore supplies to a ship electrical distribution system are to be constructed in accordance with IEC 60092-303, IEC 60076 for transformers and IEC 60146-1-series for semiconductor converters, as applicable.

3.1.2 The effect of harmonic distortion and power factor is to be considered in the assignment of a required power rating.

3.1.3 Requirements in [Section 6](#) is to also be observed.

### 3.2 Degree of Protection

The protection of electrical equipment shall be in accordance with [Section 1.K.2](#) as applicable.

## C. Ship to Shore Connection and Interface

### 1. Cable management system

#### 1.1 General

1.1.1 A cable management system (cable reels, crane, etc) enabling the connection of cables between the Shore connection switchboard and the ship receiving switchboard and suitable for the different places where the vessel intends to connect is to be provided.

**1.1.2** Cable management system, cables are to be equipped with warning notices to highlight the presence of high voltage, moving parts, obstacles, risks of fall.

**1.1.3** The cable management system is to be arranged to provide an adequate movement compensation (due to ship movement, tidal changes) and to maintain an optimum length of cable which avoids slack cable or exceeding of tension limits.

**1.1.4** The cable management system is to ensure that the cable tension does not exceed the permitted design value.

**1.1.5** The cable management system is to be equipped with a device (e.g. limit switches), independent of its control system, to monitor maximum cable tension and deployed cable length.

**1.1.6** The detection of tension in the cable is to activate an alarm at a first stage and an emergency shutdown at a second stage.

**1.1.7** Cable management system, cables are to be physical protected against heavy seas and mechanical damages.

**1.1.8** Power connections with external electrical power supply arrangements may be made with either suitable connections or by using socket-outlets and plugs in accordance with 2.

**1.1.9** Power, control and monitoring cables is to be at least of a flame-retardant type in accordance with the requirements given in IEC 60332-1-2. The outer sheath shall be oil resistant and resistant to sea air, seawater, solar radiation (UV) and no hygroscopic.

**1.1.10** Power, control and monitoring may be based on a single cable or cables in bunch.

**1.1.11** Arrangements is to be provided to stow the cable management system and associated cable when not in operation.

**1.1.12** The break away capability of the vessel is to be demonstrated. The time necessary to disconnect the shore connection system is to be recorded.

**1.1.13** Consequences of mooring breaks on the shore connection are to be considered. It shall not lead to critical damages on the installation.

## **2. Connection equipment**

### **2.1 Plugs and socket-outlets**

**2.1.1** The plug and socket-outlet arrangement are to be fitted with a mechanical-securing device that locks the connection in engaged position.

**2.1.2** The plugs and socket-outlets are to be designed so that an incorrect connection cannot be made.

**2.1.3** Socket-outlets and inlets are to be interlocked with the earth switch so that plugs or connectors cannot be inserted or withdrawn without the earthing switch in closed position. The earthing contacts shall make contact before the power contacts do when inserting a plug.

**2.1.4** Plugs are to be designed so that no strain is transmitted to the terminals, contacts and cables.

**2.1.5** Connection plug and socket-outlets are to be designed according to international or national standards. Another standard will be considered on the case-by-case basis.

**2.1.6** Type tests are to be carried out on power connection plug and socket-outlets to verify that the design is suitable for the intended application.

Type test reports are to be submitted.

**2.1.7** LV plugs and socket-outlets are to be type tested in the following order:

## 7) Electrical tests:

- partial discharge test: 10 pC at 10kV in accordance with IEC 60502-4
- A.C. voltage test: 28 kV for 5 minutes in accordance with IEC 60502
- short time and peak withstand current test in accordance with IEC 60309-5,
- impulse withstand voltage test in accordance with IEC 60947-1
- temperature rise test in accordance with IEC 60309-1 clause 22

## 8) Mechanical tests:

- mechanical strength test IK10 in accordance with IEC 62262
- normal operation test in accordance with IEC 60309-1 clause 21 (5000 cycles; for main contacts only off-load, for pilot contacts on-load)
- degree of protection in accordance with IEC 60529
- ageing of gasket and insulator in accordance with IEC 60309-1 clause 13
- corrosion and resistance to rusting in accordance with IEC 60309-1 clause 28
- environmental tests to demonstrate compliance with IEC 60092-101, Annex B and IEC 60721-3-6 for the ship environment following IEC TR 60721-4-6
- pilot contact is to be tested according to IEC 60947-5-1. The degree of protection is to be at least IP20 when not plugged.

## D. Ship Installation

### 1. General

#### 1.1 Electrical installation

**1.1.1** Permanently fixed cables are to be provided between the shore connection switchboard and the ship receiving switchboard connection point.

**1.1.2** An earth connection is to be provided for connecting the hull to an earth appropriate for the external electrical power.

**1.1.3** Arrangements are to be provided to check the insulation between Connection Equipment conductors and between the conductors and earth prior to the connection of an external power supply.

**1.1.4** Means are to be provided for checking the phase sequence of the incoming supply in shore connection switchboard.

**1.1.5** An indicator is to be provided at the Shore Connection switchboard, and at the main switchboard, in order to show when connections are energized.

**1.1.6** The shore connection switchboard is to be located onboard the vessel in a dry space close to the connection point, for the reception and / or extension of the ship to shore connection cable. The degree of protection is to be in accordance with [Section 1.K.2](#).

#### 1.2 Protection

**1.2.1** The shore connection switchboard is to be equipped with:

- Voltmeter, all three phases
- Short-circuit devices: tripping and alarm
- Overcurrent devices: tripping and alarm
- Earth-fault indicator: alarm
- Back-up of the protection system adequate for at least 30 minutes.

1.2.2 The ship receiving switchboard is to be equipped with the following protections and alarms:

- Short-circuit: tripping with alarm
- Overcurrent in two steps: alarm and tripping with alarm,
- Earth fault: alarm and tripping if required by the type of isolation system used
- Over / under voltage in two steps: alarm and tripping with alarm
- Over / under frequency in two steps: alarm and tripping with alarm
- Reverse power: tripping with alarm\*
- Phase sequence protection with alarm and interlock.

Protection function marked with an asterisk (\*), may be omitted when load transfer via blackout is chosen.

## 2. Control and monitoring

### 2.1 Instrumentation and communication

2.1.1 If the load transfer is carried out via parallel connection (see 2.2.3), the ship receiving switchboard is to be equipped with the following instrumentation:

- Two voltmeters
- Two frequency meters
- One ammeter with an ammeter switch to enable the current in each phase to be read or an ammeter in each phase
- Phase sequence indicator or lamps
- One synchronising device.

**Note:**

*One voltmeter and one frequency meter shall be connected to the switchboard busbars, the other voltmeter and frequency meter shall be switched to enable the voltage and frequency of the connection to be measured.*

2.1.2 If the load transfer is carried out via black out (see 2.2.2), the ship receiving switchboard is to be equipped with the following instrumentation:

- Two voltmeters
- Two frequency meters
- One ammeter with an ammeter switch to enable the current in each phase to be read, or an ammeter in each phase
- Phase sequence indicator or lamps

**2.1.3** Arrangements shall be provided to ensure that the shore connection circuit-breakers cannot be operated when:

- The pilot contact circuit is not established
- Emergency-stop facilities are activated
- Ship or shore control, alarm or safety system self-monitoring properties detect an error that would affect safe connection
- The data-communication link between shore and ship is not operational
- The voltage supply is not present
- Earth fault is detected.

**2.1.4** The measuring point for all instrumentation related to the shore power is to be on the upstream side of the incoming circuit breaker that isolates the shore power from the vessels power system.

**2.1.5** An independent means of voice communication e.g. two way radio is to be provided between the ship and the shore control locations.

## **2.2 Electrical load transfer**

**2.2.1** Load transfer between operation using ship sources of electrical power and an external electrical power supply is to be provided via black out or synchronization between the two sources.

**2.2.2** In case of load transfer via black out, means are to be provided to ensure that the shore supply can only be connected to a dead switchboard.

**2.2.3** Temporary parallel connection for load transfer, when provided, is to be in accordance with [2.2.4](#) to [2.2.8](#).

**2.2.4** Means to automatically synchronize a ship source of electrical power with an external electrical power supply and connect them in parallel for load transfer are to be provided.

**2.2.5** The load transfer is to be completed in a time as short as practicable without causing machinery or equipment failure or operation of protective devices. This time shall be used as the basis for defining the transfer time limit.

**2.2.6** The transfer time limit is to be defined and made available to responsible personnel.

The transfer time limit may be adjustable to match with the ability of the external source of electrical power to accept and shed load.

**2.2.7** When transferring of load between ship sources of electrical power and an external electrical power supply exceeds a defined Transfer Time Limit then, arrangements are to be such that:

- The transfer is aborted
- Load is removed from the ship sources of electrical power or external electrical power supply that was intended to take the load
- The connection Circuit-Breaker is opened.

**2.2.8** An alarm is to be provided at a machinery control station that is attended when connected to an external electrical power supply when the transfer time limit is exceeded and is to indicate the return to previous operating conditions.

## E. Testing and Trials

### 1. Initial tests

#### 1.1 General

**1.1.1** All systems components shall have passed type tests and routine tests according to the relevant IEC standards.

**1.1.2** Electrical and control engineering equipment is to be surveyed at manufacturer's works and undergo survey and operational trials on board in accordance with the approved test schedules and applicable testing requirements in [Section 20](#).

**1.1.3** Tests shall be carried out to demonstrate that the electrical system, control, monitoring and alarm systems have been correctly installed and are in good working order before being put into service. Tests shall be based on actual condition and simulations avoided as far as is practicable.

**1.1.4** Following tests shall be carried out after completion of the installation.

- Visual inspection
- Power frequency test
- Insulation resistance measurement
- Measurement of the earthing resistance
- Function test including correct settings of the protection devices
- Function test of the interlocking system
- Function test of the control equipment
- Load transfer (black out or synchronization, if applicable)
- Phase-sequence test
- Function test of the cable management system where applicable
- Integration test to demonstrate that the ship-side installations such as the power management system, integrated alarm, monitoring and control system work properly.

### 2. Additional tests and maintenance

#### 2.1 General

**2.1.1** An overall compatibility assessment is to be carried out to verify the possibility to connect the ship to the different shore supply.

**2.1.2** A record of annual maintenance, repair, equipment modifications and the test results are to be available for the shore and ship side.



## Annex B Requirements for Additional Generator

A.	General . . . . .	B-1
B.	Temporary Additional Generator . . . . .	B-1
C.	Permanent Additional Generator . . . . .	3

### A. General

#### 1. Scope

- 1.1 The requirement in this Annex applies to additional generators installed outside of engine room
- 1.2 For additional generators installed temporarily, refer to B. The requirements for additional generator that is installed permanently is given in C.

#### 2. Documents to be submitted

The drawings and documents listed in [Section 1.C.1, Table 1.2](#) shall be submitted and approved by BKI prior to installation of the additional generators, particularly drawings and documents related to generators and their corresponding installation as listed below:

- 1) General layout drawings of additional generator installation (refer to [Section 1.C.1, Table 1.2, point 2.1](#))
- 2) Documentations for generators and their corresponding main switchgear (refer to [Section 1.C.1, Table 1.2, point 2.2 and 2.7](#))
- 3) Documentations for main distribution board, if any (refer to [Section 1.C.1, Table 1.2, point 2.9](#))
- 4) Cable layout/list (refer to [Section 1.C.1, Table 1.2, point 2.14](#))
- 5) Documentations for fire detection and alarm system, if applicable (refer to [Section 1.C.1, Table 1.2, point 6.4](#))
- 6) Documentations for fixed water-based local application fire-fighting systems (FWBLAFFS), if applicable (refer to [Section 1.C.1, table 1.2, point 6.13](#))

### B. Temporary Additional Generator

#### 1. Scope and application

- 1.1 Temporary additional generator is not permitted for oil tanker, chemical tanker, gas carrier, and cargo ships which carries dangerous goods
- 1.2 Temporary additional generator is only permitted for ships sailing domestically in Indonesian waters
- 1.3 The usage of temporary additional generator is allowed as a replacement of 1 (one) main generator that is damaged or being repaired. This generator can only be placed in ship with the duration of not more than 3 months after the documents/drawing are approved by BKI.

#### 2. Location and protection

- 2.1 Generator must be placed safely on the deck at the position of stringer or other adequate structure

2.2 Generator with power below 375 kW that is placed on open area must be placed inside enclosure with minimum IP of 56

2.3 Generator with power greater than 375 kW must be placed in closed area which has equivalent safety level with category A60 engine room and minimum protection of IP56

2.4 Generator is not to be placed in below areas:

- Inside category A engine room (for generator with power greater than 375 kW)
- Car deck (for Ferry or Ro-ro ship)
- Area adjacent to accommodation room (side by side, on top or bottom)
- Other area with hazards as defined in [Section 1.K.3](#).

2.5 The area where the generator is placed must be well ventilated to keep the room temperature below 45°C.

2.6 Generator must be placed within the range of fixed fire fighting equipment and not obstructed by structures that will hinder fire fighting process from outside the ship

2.7 A protection mechanism must be provided to protect generator from direct or indirect contact. Sufficient earthing must also be provided.

### 3. Capacity

3.1 The power and capacity of the generator must not be greater than the replaced main generator

3.2 The generator must be of sufficient capacity as required in [Section 3.B.1.2](#).

### 4. Type and drive

4.1 Generator with power greater than 375 kW must be certified by BKI and suitable for marine use

4.2 Generator driver must use marine type diesel engine or other type approved by BKI Head Office. Sufficient protection must be provided

4.3 Ventilation for the engine must be of sufficient capacity. When placed on freeboard deck, the ventilation must not be shorter than 4,5 m.

### 5. Installation

5.1 Requirements in [Section 12](#) and [Section 20.F](#) must be considered for cable penetration and wiring to main switchboard. Marine use and flame retardant cable must be used for installation.

5.2 Fuel tank must be made of steel and placed in the same room as the generator.

5.3 If fuel tank's capacity is greater than 500 litre, quick closing valve must be provided. The valve must be able to be activated from outside the room.

5.4 Requirement regarding fuel tanks in [Rules for Machinery Installations \(Pt.1, Vol.III\) Sec.10.B.2](#) shall be observed as applicable

### 6. Testing

After installation, the additional generator must be tested in the presence of Surveyor. The test consists of performance test, testing of protection and safety device of the generator and main switchboard, verification of generator operation (manual or automatic operation). Reference is to be made to [Section 21.D](#).

## **C. Permanent Additional Generator**

### **1. Scope and application**

- 1.1 Temporary additional generator is not permitted for oil tanker, chemical tanker, gas carrier, and cargo ships which carries dangerous goods
- 1.2 Temporary additional generator is only permitted for ships with service area of **P, L, T and D**
- 1.3 The usage of temporary additional generator is allowed as a supplement of the existing generator so that the total capacity is sufficient for operational need.

### **2. Location and protection**

- 2.1 Generator must be placed safely on the deck at the position of stringer or other adequate structure
- 2.2 Generator must be placed in closed area which has equivalent safety level with category A60 engine room and minimum protection of IP56
- 2.3 The room housing the generator must be equipped with fire detection equipment, ventilation along with its cover and fire-fighting equipment as required by Rules for Machinery Installation (Pt.1, Vol.III).
- 2.4 When placed adjacent to accommodation room, the room housing the generator must be insulated with A60 insulation.
- 2.5 A protection mechanism must be provided to protect generator from direct or indirect contact. Sufficient earthing must also be provided

### **3. Type and drive**

- 3.1 Generator must be suitable for marine use
- 3.2 Generator driver must use marine type diesel engine or other type approved by BKI Head Office. Sufficient protection must be provided
- 3.3 Ventilation for the engine must be of sufficient capacity. When placed on freeboard deck, the ventilation must not be shorter than 4,5 m.

### **4. Installation**

- 4.1 Requirements in [Section 12](#) and [Section 20.F](#) must be considered for cable penetration and wiring to main switchboard. Marine use and flame retardant cable must be used for installation.
- 4.2 An individual main switchboard, separated from existing main switchboard, must be provided for the exclusive use of the additional generator. The main switchboard must be equipped with protection and measurement devices which complies to the corresponding requirement in [Section 4](#) and [5](#).
- 4.3 Fuel tank must be made of steel and placed in the same room as the generator.
- 4.4 If fuel tank's capacity is greater than 500 litre, quick closing valve must be provided. The valve must be able to be activated from outside the room.
- 4.5 Requirement regarding fuel tanks in Rules for Machinery Installations (Pt.1, Vol.III) Sec.10.B.2 shall be observed as applicable

### **5. Testing**

After installation, the additional generator must be tested in the presence of Surveyor. The test consists of performance test, testing of protection and safety device of the generator and main switchboard, verification of generator operation (manual or automatic operation). Reference is to be made to [Section 21.D](#).

*This page intentionally left blank*